

Excellent Integrated System Limited

Stocking Distributor

Click to view price, real time Inventory, Delivery & Lifecycle Information:

[t-Global Technology](#)
[LP0002/01-L37-3F-0.3-2A](#)

For any questions, you can email us directly:

sales@integrated-circuit.com

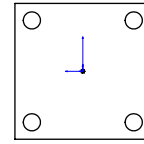
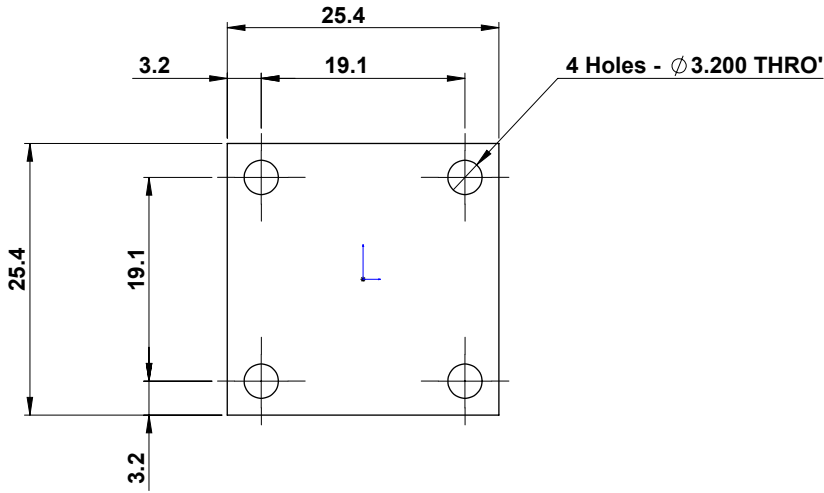

Reference View

Scale: Full Size

UNLESS OTHERWISE SPECIFIED:
DIMENSIONS ARE IN Millimetres
SURFACE FINISH:
TOLERANCES:
LINEAR:
ANGULAR:

	NAME	DATE
DRAWN	L. Simpson	15 th July 2012
CHK'D		
APPV'D		
MFG		
Q.A		

**t-Global
Technology**

MATERIAL:
**t-Global Thermal
Material L37-3F**
Thickness T = 0.3mm.

PART No.

LP0002/01-L37-3F-0.3-2A

WEIGHT:

DO NOT SCALE DRAWING

REVISION

LP0002/01-Material Ref.-Thickness(T mm.)

Ordering No. LP0002/01-L37-3F-0.3-2A

TITLE:

LUMI-PAD
For LED Configuration

A4

SCALE: 2:1

SHEET 1 OF 1