

Excellent Integrated System Limited





Stocking Distributor

Click to view price, real time Inventory, Delivery & Lifecycle Information:

[Bel Fuse Inc.](#)
[PL155-29](#)

For any questions, you can email us directly:
sales@integrated-circuit.com



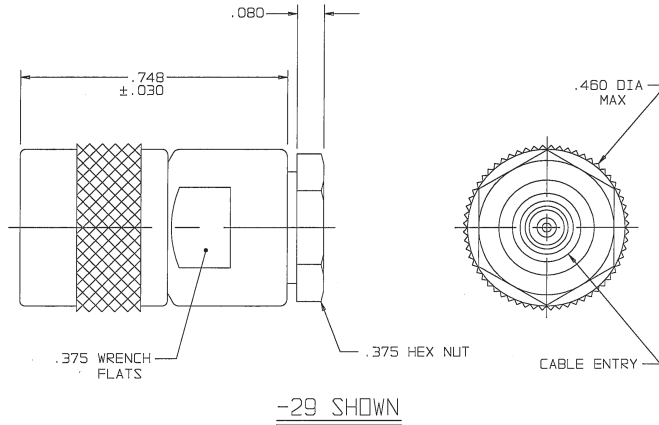

DASH NO	CABLES ACCOMMODATED	ASSEMBLE PER
-23	275-3930, MICRODOT	TAI-127
-24	202-3934, MICRODOT	TAI-125
-24A	9530A5117, RAYCHEM	TAI-127
-27	202-3927, MICRODOT  73-1317911-1, SYLVANIA	TAI-125
-29	TWC-124-1A TWC-78-1	TAI-125
-30	B441, BELDEN  761A, W.E.CO.	TAI-127
-32	TRC-50-1	TAI-127
-33	TRC-75-1	TAI-127
-43	250-4044/250-4045 293-3930 MICRODOT	TAI-174
-45	10602, RAYCHEM	TAI-125
-47	M17/176-00002 	TAI-125
-49	TWAC-78-1F2 	TAI-174
-56	GC875GC1, GRUMMAN	TAI-125
-57	GC875GB1, GRUMMAN	TAI-125
-58	GC875TM24H, GRUMMAN	TAI-125
-55	TWCP-124-3	TAI-125

REVISIONS		310-0036	SH 1
REV	DESCRIPTION	DATE	APPROVED
V	REVISED PER ECD 15485	2/14/04	



RED INDICATES ORIGINAL

-  .187 LG JACKET SLITS MAY BE REQUIRED FOR EASE OF ASSY
-  NOT WRENCH CRIMP
- 3. CONCENTRIC TWINAX/TRIAX SUBMINIATURE 3-LUG TRS PLUG
- 2. FINISH: TFS-1A (NICKEL)
- 1. ALL DIM ARE IN INCHES

<small>TROMPETER DRAWING FILE NUMBER: IS NOT TO BE USED FOR IDENTIFICATION PURPOSES UNLESS SPECIFIED BY THE MANUFACTURER'S EXPERIENCES INC.</small>		<small>TIT. PREFIX SPECIFIED: .XXX & 001 .XXX & 005 .XXXX & 0010 ANGLES: 0° 90°</small>			
<small>DRAWN: 310-0029</small> <small>DATE: 6-10-04</small> <small>CHECKED: 305-0394</small> <small>DATE: 6-10-04</small> <small>BY: 3-0040</small> <small>DATE: 02/14/04</small> <small>3-0029</small> <small>DATE: 02/14/04</small> <small>205-0029</small> <small>DATE: 02/14/04</small> <small>1-0451</small> <small>DATE: 02/14/04</small>	<small>INTRODUCED:</small> <small>FINISH:</small>	<small>TITLE:</small> PL155	<small>SIZE:</small> B 14949	<small>DRAWING NO.:</small> 310-0036	<small>REV.:</small> V
<small>NEXT ASSY:</small> 310-0036V	<small>DO NOT SCALE DIM:</small>	<small>SCALE:</small> 4/1	<small>DATE:</small> 6/20/05	<small>SHEET:</small> 1C	