

Excellent Integrated System Limited

Stocking Distributor

Click to view price, real time Inventory, Delivery & Lifecycle Information:

[Molex Connector Corporation](#)
[1201140043](#)

For any questions, you can email us directly:

sales@integrated-circuit.com

10 9 8 7 6 5 4 3 2 1

TABLE 1 BILL OF MATERIAL

ITEM	QTY	DESCRIPTION	MATERIAL	FINISH
1	5	LABEL	ABS	WHITE
2	1	CABLE PLATE	PBT	YELLOW
3	1	CABLE	SEE ENG. NO. MATRIX	SEE ENG. NO. MATRIX
4	20	CONTACT	BRASS	GOLD OVER NICKEL
5	4	O-RING	FPM	RED
6	4	SHELL	BRASS	NICKEL PLATED
7	9	LED	NON LED = PBT/ WITH LED = PA	NON LED=YELLOW/ WITH LED=TRANSPARENT
8	2	PROTECTING CAP	PP	BLACK
9	1	HOUSING	PBT	YELLOW

GENERAL CHARACTERISTICS

NOMINAL VOLTAGE: 10-30 V DC
 POLLUTION DEGREE: 3
 RATED CURRENT: 4 A PER PORT / 12 A MAX: TOTAL
 CONTACT RESISTANCE: ≤ 5 mOHM
 ISULATION RESISTANCE: > 10¹⁰ OHM
 IP DEGREE OF PROTECTION: IP 67
 IP 68 REFER TO TEST SUMMARY TS-120005-016

TEMPERATURE RANGE: -25°C to + 85°C
 (BOX ONLY)

FLAMMABILITY:
 Insert: V0
 HOUSING: V0
 POTTING MATERIAL: V0

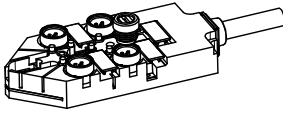
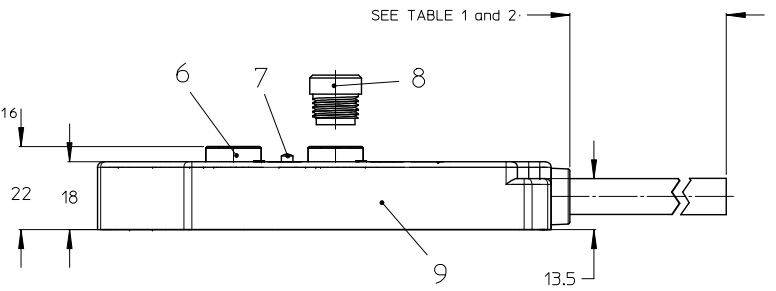
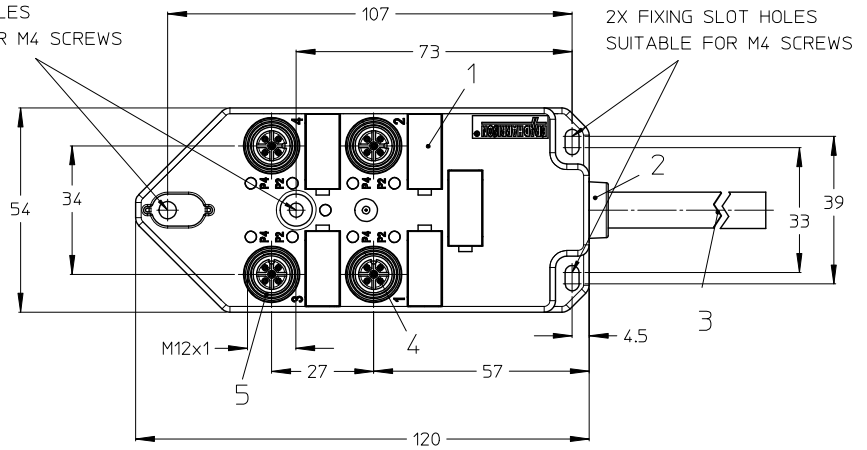

ENTER DESCRIPTION EC NO: IPG2014-0267 DRAWN BY: ULETENMEIER 2013/09/24 CHKD BY: SILLER 2013/09/25 APPR: CBURGER 2013/10/07	QUALITY SYMBOLS ▼=0 ▽=0	GENERAL TOLERANCES (UNLESS SPECIFIED) 4 PLACES ± --- ± --- 3 PLACES ± --- ± --- 2 PLACES ± 0.05 ± --- 1 PLACE ± 0.10 ± --- 0 PLACE ± --- ± --- ANGULAR ± 5°	DIMENSION STYLE MM ONLY DRAWN BY: ULETENMEIER 2013/07/02 CHECKED BY: SILLER 2013/07/10 APPROVED BY: CBURGER 2013/07/17	SCALE: 1:1 DESIGN UNITS: METRIC THIRD ANGLE PROJECTION	TITLE: MPIS M12 PNP NPN NOS 5P 4PT AC FE STR XM molex
	DRAFT WHERE APPLICABLE MUST REMAIN WITHIN DIMENSIONS	MATERIAL NO. SEE TABLE 2	DOCUMENT NO. SD-120114-093	SHEET NO. 1 OF 3	

9 8 7 6 5 4 3 2 1

10 9 8 7 6 5 4 3 2 1

WIRING DIAGRAM DUAL PORT PNP

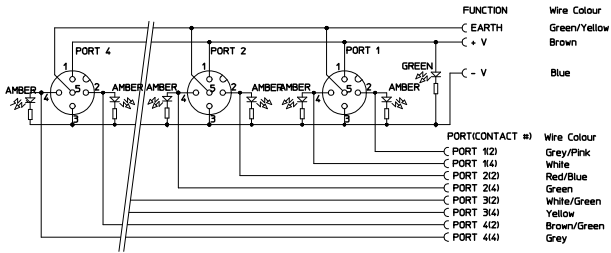

WIRING DIAGRAM DUAL PORT NPN

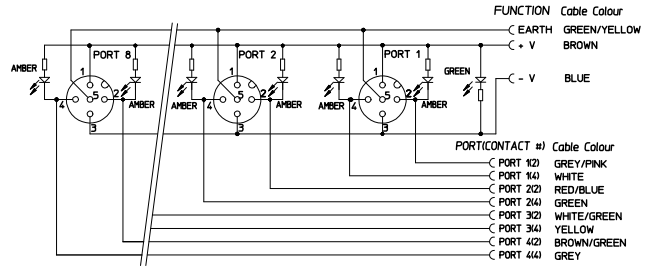

WIRING DIAGRAM DUAL PORT NON LED

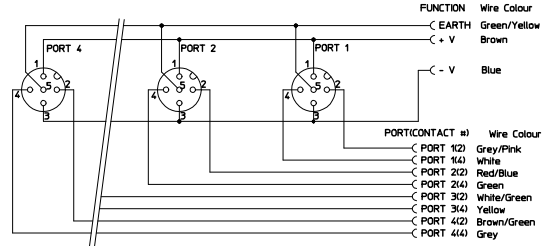

ENTER DESCRIPTION EC NO: IPG2014-0267 DRAWN BY: ULETENMEIER 2013/09/24 CHECKED BY: RSILLER 2013/09/25 APPR: CBURGER 2013/07/07	QUALITY SYMBOLS ▽=0 ▽=0	GENERAL TOLERANCES (UNLESS SPECIFIED)		DIMENSION STYLE MM ONLY		SCALE 1:1	DESIGN UNITS METRIC	THIRD ANGLE PROJECTION
		4 PLACES ± --- ± ---	DRAWN BY DATE ULETENMEIER 2013/07/02	TITLE MPIS M12 PNP NPN NOS 5P 4PT AC FE STR XM				
		3 PLACES ± --- ± ---	CHECKED BY DATE RSILLER 2013/07/10	molex				
		2 PLACES ± 0.05 ± ---	APPROVED BY DATE CBURGER 2013/07/17					
1 PLACE ± 0.10 ± ---	ANGULAR ± 5°		MATERIAL NO.	DOCUMENT NO.	SHEET NO.			
0 PLACE ± --- ± ---	DRAFT WHERE APPLICABLE MUST REMAIN WITHIN DIMENSIONS		SEE TABLE 2	SD-120114-093	2 OF 3			
SIZE A		THIS DRAWING CONTAINS INFORMATION THAT IS PROPRIETARY TO MOLEX INCORPORATED AND SHOULD NOT BE USED WITHOUT WRITTEN PERMISSION						

9 8 7 6 5 4 3 2 1

TABLE 2

MOLEX P/N	ENG. NO.	LED	MOLEX P/N	ENG. NO.	LED
1200550604	BTY405P-FBE-10	YES	1201140187	BTY405P-FBE-05	YES
1200550671	BTY405P-FBI-10	YES	1201140188	BTY405P-FBP-20	YES
1200550696	BTY405P-FBI-15	YES	1201140189	BTY4050-FBE-05	NO
1200550737	BTY405P-FBE-20	YES	1201145036	BTY405P-FBP-05WE	YES
1200550911	BTY405P-FBP-30	YES	1201145037	BTY405P-FBP-10WE	YES
1201140037	BTY405N-FBP-05	YES	1201148028	BTY405P-FBP-15-1	YES
1201140038	BTY405N-FBP-10	YES			
1201140039	BTY405P-FBP-05	YES			
1201140040	BTY405P-FBP-10	YES			
1201140041	BTY405P-FBP-15	YES			
1201140042	BTY4050-FBP-05	NO			
1201140043	BTY4050-FBP-10	NO			
1201140044	BTY4050-FBP-15	NO			
1201140186	BTY405N-FBP-25	YES			

ENG. NO. MATRIX:

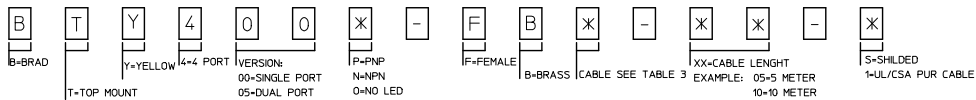

TABLE 3

CABLE	TEM. RANGE STATISCH	TEM. RANGE FLEXIBLE	CABLE DIAMETER (MM) SIGLE (4POLE) 4/6/8 PORT	CABLE DIAMETER (MM) DUAL (5POLE) 4/6/8 PORT	DRAG CHAIN	UL STYLE
P=PUR/PVC/Black	-30°C TO +90°C	-5°C TO +90°C	8.4 ±0.2 / 9.5±0.2 / 9.5 ±0.2	9.5 ±0.2 / 9.8 ±0.2 / 11.4 ±0.2	1.5 MID. CYCLES	-
P=PUR/PVC/Black/UL/CSA	-25°C TO +90°C	-	7.5 ± 0.2	8.6 ± 0.2	-	-
N=PVC/GREY	-	-10°C TO +80°C	8.4 ± 0.2	9.5 ± 0.2	10 MID. CYCLES	2464
I=CEI/GREY	-5°C TO +70°C	-	8.4 ± 0.2	9.5 ± 0.2	-	-
E=PVC/YELLOW	-5°C TO +70°C	-	8.4 ± 0.2	9.5 ± 0.2	-	-

ENTER DESCRIPTION EC NO: IPC2014-0267 DRAWN BY: ULETTENMEIER 2013/09/24 CHECKED BY: CHIKORSILLER 2013/09/25 APPR: LOUGER 2013/10/07 REV:	QUALITY SYMBOLS ▽=0 ▽=0	GENERAL TOLERANCES (UNLESS SPECIFIED) mm INCH 4 PLACES ± --- ± --- 3 PLACES ± --- ± --- 2 PLACES ± 0.05 ± --- 1 PLACE ± 0.10 ± --- 0 PLACE ± --- ± ---	DIMENSION STYLE MM ONLY	SCALE 1:1	DESIGN UNITS METRIC	THIRD ANGLE PROJECTION
	MATERIAL NO. SEE TABLE 2	DOCUMENT NO. SD-120114-093	SHEET NO. 3 OF 3			