



Excellent Integrated System Limited

Stocking Distributor

Click to view price, real time Inventory, Delivery & Lifecycle Information:

[ITT Cannon, LLC](#)
[KPSE00E14-12SDN](#)

For any questions, you can email us directly:

sales@integrated-circuit.com

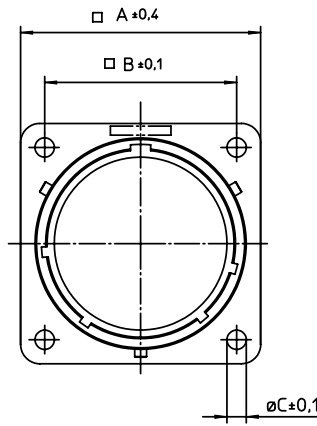
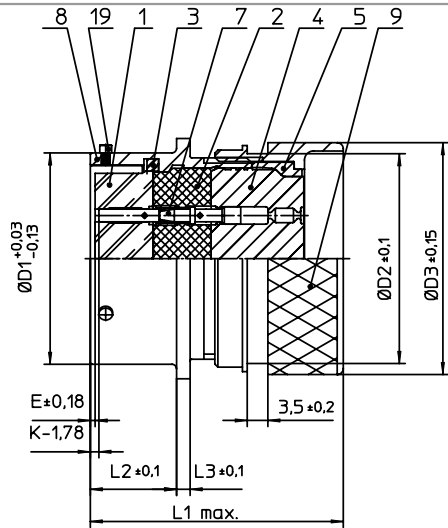

NO.	MASSE / DIMENSION
A	28.5
B	23
C	3.2
D1	22.23
D2	22
D3	24.4
E	0.46
K	3.89
L1	36
L2	11.6
L3	1.9

NO.	BESCHREIBUNG / DESCRIPTION
1	ISOLIERKÖRPER BUCHSE / INSULATOR SOCKET
2	ISOLIERKÖRPER MITTE / WAYER
3	DICHTRING / GASKET
4	DICHTKÖRPER / GROMMET
5	ENDRING / ENDRING
7	KONTAKT BUCHSE / CONTACT SOCKET
8	GEHÄUSE / RECEPTACLE
9	DN-ENDGEHÄUSE / DN-ENDBELL
19	BAYONETTSTIFT / BAYONET PIN

Note: Due to an automatic nomenclature system, numbers generated may not be sequential.
Specification and Dimensions subject to change
Drawings illustrate normal insulator positioning

Material Specification:	
Shell Material:	Aluminium alloy
Shell Plating:	Olive drab chromate over cadmium plating
Insulator Material:	Polychloroprene
Contact Material:	Copper alloy, gold plated
Contact Plating:	Copper alloy, gold plated

all dimensions are in mm
Dimensions without tolerance indications are general tolerances in acc. with DIN7168m

drawing for
CUSTOMER



description KPSE00E1412S-DN
Wall mounting receptacle
Shrink boot adapter
Crimp Contacts / Socket / Layout: 14-12

© All rights reserved. Reproduction or issue to third in any form without written authorization of ITT Cannon
page 1/1 revision 1012.5, Jul 16