



## **Excellent Integrated System Limited**

Stocking Distributor

Click to view price, real time Inventory, Delivery & Lifecycle Information:

[ITT Cannon, LLC](#)  
[KPSE07A14-12P](#)

For any questions, you can email us directly:

[sales@integrated-circuit.com](mailto:sales@integrated-circuit.com)

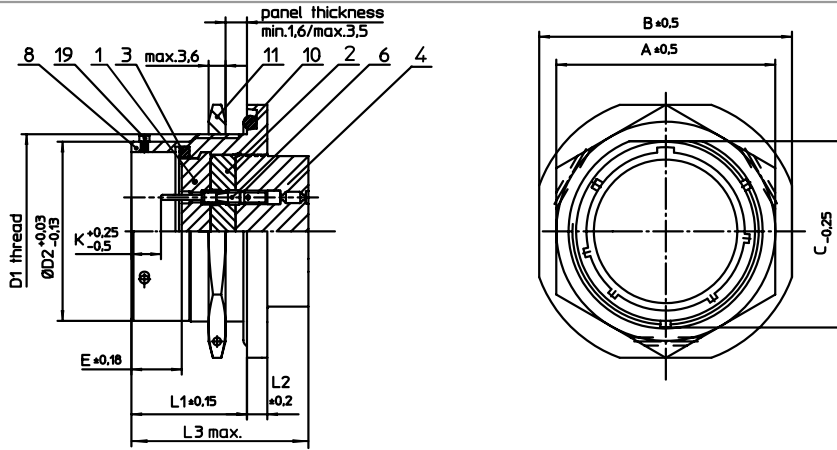

NO.	MASSE / DIMENSION
A	30.3
B	35
C	23.9
D1	1-20UNEF-2A
D2	22.23
D3	39
E	8.25
K	2.16
L1	29
L2	3.2
L3	17.7

NO.	BESCHREIBUNG / DESCRIPTION
1	ISOLIERKÖRPER STIFT / INSULATOR PIN
2	ISOLIERKÖRPER MITTE / WAYER
3	DICHTRING / GASKET
4	DICHTKÖRPER / GROMMET
6	KONTAKT STIFT / CONTACT PIN
8	GEHÄUSE / RECEPTACLE
10	O-RING / O-RING
11	SECHSKANTMUTTER / HEX NUT
19	BAYONETTSTIFT / BAYONET PIN

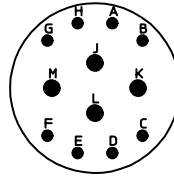

Note: Due to an automatic nomenclature system, numbers generated may not be sequential.  
Specification and Dimensions subject to change  
Drawings illustrate normal insulator positioning

Material Specification:	
Shell Material:	Aluminium alloy
Shell Plating:	Olive drab chromate over cadmium plating
Insulator Material:	Polychloroprene
Contact Material:	Copper alloy, gold plated
Contact Plating:	Copper alloy, gold plated

all dimensions are in mm  
Dimensions without tolerance indications are general tolerances in acc. with DIN7168m

drawing for  
CUSTOMER



description  
KPSE07A1412P  
Jam nut receptacle  
General duty  
Crimp Contacts / Pin / Layout: 14-12

© All rights reserved. Reproduction or issue to third in any form  
whenever is only permitted with written authorization of ITT Cannon

page 1/1  
revision 1012 5. Jul 16