



Excellent Integrated System Limited

Stocking Distributor

Click to view price, real time Inventory, Delivery & Lifecycle Information:

[ITT Cannon, LLC](#)
[KPSE0E20-39PDN](#)

For any questions, you can email us directly:

sales@integrated-circuit.com

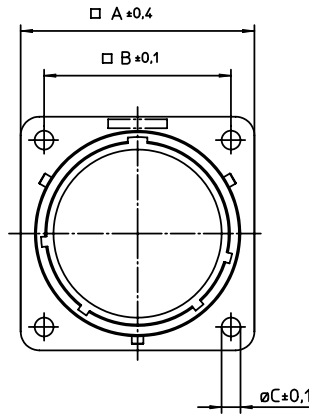
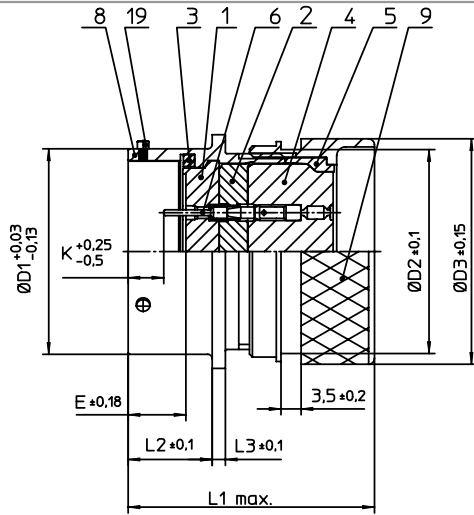

NO.	MASSE / DIMENSION
A	36.5
B	29.4
C	3.2
D1	31.75
D2	32.3
D3	36
E	9.82
K	3.73
L1	43
L2	14.2
L3	2.2

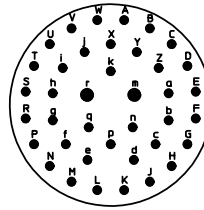

NO.	BESCHREIBUNG / DESCRIPTION
1	ISOLIERKÖRPER STIFT / INSULATOR PIN
2	ISOLIERKÖRPER MITTE / WAVER
3	DICHTRING / GASKET
4	DICHTKÖRPER / GROMMET
5	ENDRING / ENDRING
6	KONTAKT STIFT / CONTACT PIN
8	GEHÄUSE / RECEPTACLE
9	DN-ENDGEHÄUSE / DN-ENDBELL
19	BAYONETTSTIFT / BAYONET PIN

Note: Due to an automatic nomenclature system, numbers generated may not be sequential.
 Specification and Dimensions subject to change
 Drawings illustrate normal insulator positioning

Material Specification:	
Shell Material:	Aluminium alloy
Shell Plating:	Olive drab chromate over cadmium plating
Insulator Material:	Polychloroprene
Contact Material:	Copper alloy, gold plated
Contact Plating:	Copper alloy, gold plated

all dimensions are in mm
 Dimensions without tolerance indications are general tolerances in acc. with DIN7168m

drawing for
 CUSTOMER



description
 KPSE0E2039P-DN
 Wall mounting receptacle
 Shrink boot adapter
 Crimp Contacts / Pin / Layout: 20-39

© All rights reserved. Reproduction or issue in any form
 whatever is only permitted with written authorization of ITT Cannon. page 1/1 revision 1012.5, Jul 16