

Excellent Integrated System Limited

Stocking Distributor

Click to view price, real time Inventory, Delivery & Lifecycle Information:

[Texas Instruments](#)
[LMV751M5/NOPB](#)

For any questions, you can email us directly:

sales@integrated-circuit.com

LMV751 Low Noise, Low Vos, Single Op Amp

Check for Samples: [LMV751](#)

FEATURES

- Low Noise $6.5\text{nV}/\sqrt{\text{Hz}}$
- Low V_{OS} (0.05mV typ.)
- Wideband 4.5MHz GBP typ.
- Low Supply Current 500uA typ.
- Low Supply Voltage 2.7V to 5.0V
- Ground-Referenced Inputs
- Unity Gain Stable
- Small Package

APPLICATIONS

- Cellular Phones
- Portable Equipment
- Radio Systems

Connection Diagram

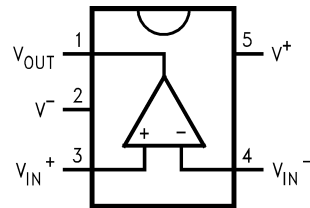

Figure 1. SOT-23-5 Top View

DESCRIPTION

The LMV751 is a high performance CMOS operational amplifier intended for applications requiring low noise and low input offset voltage. It offers modest bandwidth of 4.5MHz for very low supply current and is unity gain stable.

The output stage is able to drive high capacitance, up to 1000pF and source or sink 8mA output current.

It is supplied in the space saving SOT-23-5 Tiny package.

The LMV751 is designed to meet the demands of small size, low power, and high performance required by cellular phones and similar battery operated portable electronics.

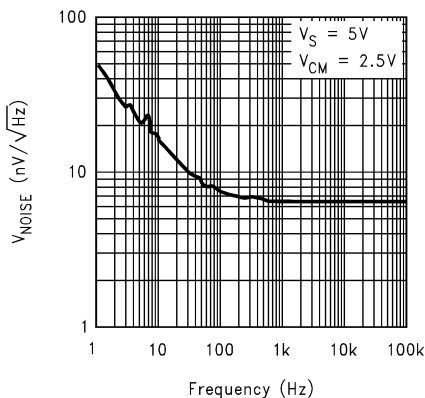

Figure 2. Voltage Noise

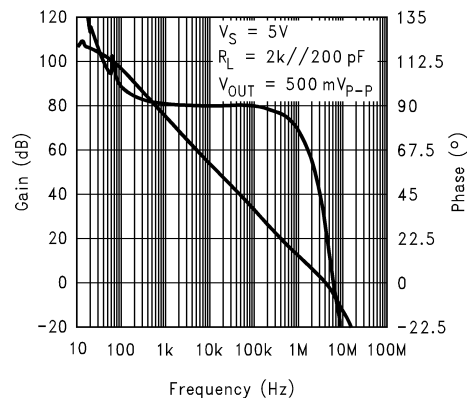

Figure 3. Gain/Phase



Please be aware that an important notice concerning availability, standard warranty, and use in critical applications of Texas Instruments semiconductor products and disclaimers thereto appears at the end of this data sheet.

All trademarks are the property of their respective owners.

LMV751

SNOS468E –AUGUST 1999–REVISED MARCH 2013

www.ti.com

These devices have limited built-in ESD protection. The leads should be shorted together or the device placed in conductive foam during storage or handling to prevent electrostatic damage to the MOS gates.

Absolute Maximum Ratings ⁽¹⁾⁽²⁾

ESD Tolerance ⁽³⁾	
Human Body Model	2000V
Machine Model	200V
Differential Input Voltage	±Supply Voltage
Supply Voltage (V ⁺ - V ⁻)	5.5V
Lead Temperature (Soldering, 10 sec.)	260°C
Storage Temperature Range	-65°C to 150°C
Junction Temperature (T _J) ⁽⁴⁾	150°C

- (1) Absolute Maximum Ratings indicate limits beyond which damage to the device may occur. Electrical specifications do not apply when operating the device beyond its rated operating conditions.
- (2) If Military/Aerospace specified devices are required, please contact the Texas Instruments Sales Office/ Distributors for availability and specifications.
- (3) Human body model, 1.5kΩ in series with 100pF. Machine model, 200Ω in series with 1000pF.
- (4) The maximum power dissipation is a function of T_{J(MAX)}, θ_{JA}, and T_A. The maximum allowable power dissipation at any ambient temperature is P_D = (T_{J(MAX)} - T_A)/θ_{JA}. All numbers apply for packages soldered directly into a PC board.

Recommended Operating Conditions

Supply Voltage	2.7V to 5.0V
Temperature Range	-40°C ≤ T _J ≤ 85°C
Thermal Resistance (θ _{JA}) ⁽¹⁾	
DBV-5 Package, SOT-23-5	274°C/W

- (1) All numbers are typical, and apply to packages soldered directly onto PC board in still air.

2.7V Electrical Characteristics

V⁺ = 2.7V, V⁻ = 0V, V_{CM} = 1.35V, T_A = 25°C unless otherwise stated. **Boldface limits** apply over the Temperature Range.

Symbol	Parameter	Condition	Typ ⁽¹⁾	Limit ⁽²⁾	Units
V _{OS}	Input Offset Voltage		0.05	1.0 1.5	mV max
V _{CM}	Input common-Mode Voltage Range	For CMRR ≥ 50dB		0	V min
				1.4	1.3
CMRR	Common Mode Rejection Ratio	0V < V _{CM} < 1.3V	100	85 70	dB min
PSRR	Power Supply Rejection Ratio	V ⁺ = 2.7V to 5.0V	107	85 70	dB min
I _S	Supply Current		0.5	0.8 0.85	mA max
I _{IN}	Input Current		1.5	100	pA max
I _{OS}	Input Offset Current		0.2		pA
A _{VOL}	Voltage Gain	R _L = 10k Connect to V ⁺ /2 V _O = 0.2V to 2.2V	120	110 95	dB min
		R _L = 2k Connect to V ⁺ /2 V _O = 0.2V to 2.2V	120	100 85	

- (1) Typical values represent the most likely parametric norm.
- (2) All limits are ensured by testing or statistical analysis

2.7V Electrical Characteristics (continued)

$V^+ = 2.7V$, $V^- = 0V$, $V_{CM} = 1.35V$, $T_A = 25^\circ C$ unless otherwise stated. **Boldface limits** apply over the Temperature Range.

Symbol	Parameter	Condition	Typ (1)	Limit (2)	Units
V _O	Positive Voltage Swing	R _L = 10k Connect to V ⁺ /2	2.62	2.54 2.52	V min
		R _L = 2k Connect to V ⁺ /2	2.62	2.54 2.52	
V _O	Negative Voltage Swing	R _L = 10k Connect to V ⁺ /2	78	140 160	mV max
		R _L = 2k Connect to V ⁺ /2	78	160 180	
I _O	Output Current	Sourcing, V _O = 0V V _{IN} (diff) = ±0.5V	12	6.0 1.5	mA min
		Sinking, V _O = 2.7V V _{IN} (diff) = ±0.5V	11	6.0 1.5	
e _n (10Hz)	Input Referred Voltage Noise		15.5		nV/√Hz
e _n (1kHz)	Input Referred Voltage Noise		7		nV/√Hz
e _n (30kHz)	Input Referred Voltage Noise		7	10	nV/√Hz max
I _N (1kHz)	Input Referred Current Noise		0.01		pA/√Hz
GBW	Gain-Bandwidth Product		4.5	2	MHZ min
SR	Slew Rate		2		V/μs

5.0V Electrical Characteristics

$V^+ = 5.0V$, $V^- = 0V$, $V_{CM} = 2.5V$, $T_A = 25^\circ C$ unless otherwise stated. **Boldface limits** apply over the Temperature Range.

Symbol	Parameter	Condition	Typ (1)	Limit (2)	Units
V _{OS}	Input Offset Voltage		0.05	1.0 1.5	mV max
CMRR	Common Mode Rejection Ratio	0V < V _{CM} < 3.6V	103	85 70	dB min
V _{CM}	Input Common-Mode Voltage Range	For CMRR ≥ 50dB		0	V min
				3.7	3.6
PSRR	Power Supply Rejection Ratio	V ⁺ = 2.7V to 5.0V	107	85 70	dB min
I _S	Supply Current		0.6	0.9 0.95	mA max
I _{IN}	Input Current		1.5	100	pA max
I _{OS}	Input offset Current		0.2		pA
A _{VOL}	Voltage Gain	R _L = 10k Connect to V ⁺ /2 V _O = 0.2V to 4.5V	120	110 95	db min
		R _L = 2k Connect to V ⁺ /2 V _O = 0.2V to 4.5V	120	100 85	
V _O	Positive Voltage Swing	R _L = 10k Connect to V ⁺ /2	4.89	4.82 4.80	V min
		R _L = 2k Connect to V ⁺ /2	4.89	4.82 4.80	
V _O	Negative Voltage Swing	R _L = 10k Connect to V ⁺ /2	86	160 180	mV max
		R _L = 2k Connect to V ⁺ /2	86	180 200	

(1) Typical values represent the most likely parametric norm.

(2) All limits are ensured by testing or statistical analysis

LMV751

SNOS468E –AUGUST 1999–REVISED MARCH 2013

www.ti.com

5.0V Electrical Characteristics (continued)

$V^+ = 5.0V$, $V^- = 0V$, $V_{CM} = 2.5V$, $T_A = 25^\circ C$ unless otherwise stated. **Boldface limits** apply over the Temperature Range.

Symbol	Parameter		Typ (1)	Limit (2)	Units
I_O	Output Current	Sourcing, $V_O = 0V$ $V_{IN} (diff) = \pm 0.5V$	15	8.0 2.5	mA min
		Sinking, $V_O = 5V$ $V_{IN} (diff) = \pm 0.5V$	20	8.0 2.5	
e_n (10Hz)	Input Referred Voltage Noise		15		nV/ \sqrt{Hz}
e_n (1kHz)	Input Referred Voltage Noise		6.5		nV/ \sqrt{Hz}
e_n (30kHz)	Input Referred Voltage Noise		6.5	10	nV/ \sqrt{Hz} max
I_N (1kHz)	Input Referred Current Noise		0.01		pA/ \sqrt{Hz}
GBW	Gain-Bandwidth Product		5	2	MHz min
SR	Slew Rate		2.3		V/ μ s

Typical Performance Characteristics

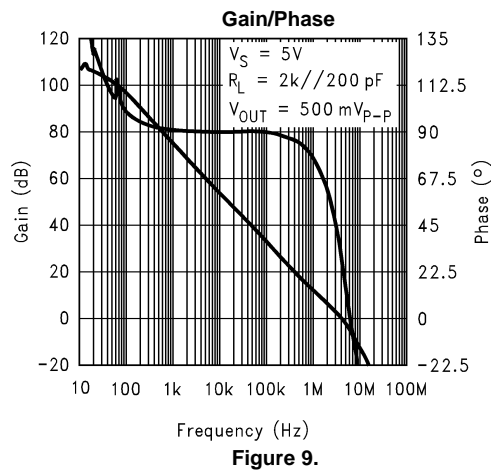
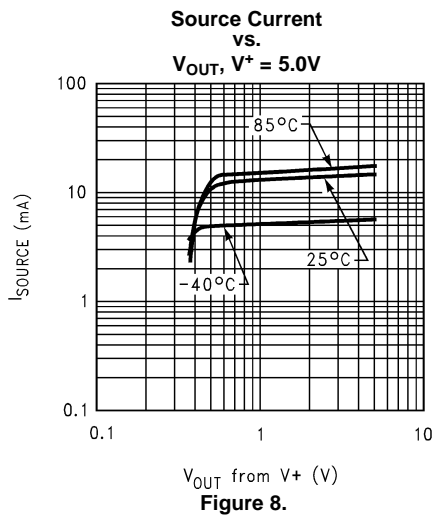
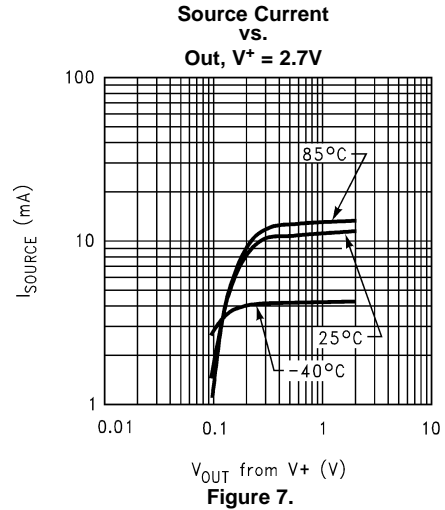
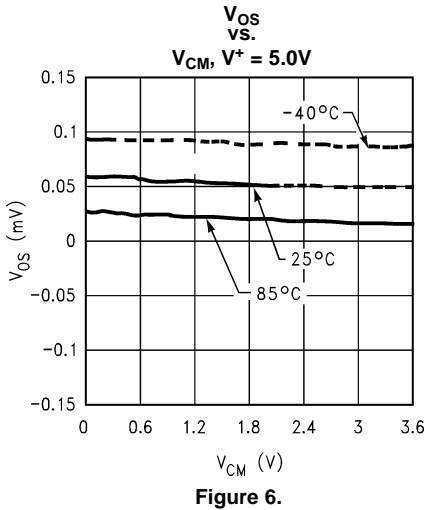
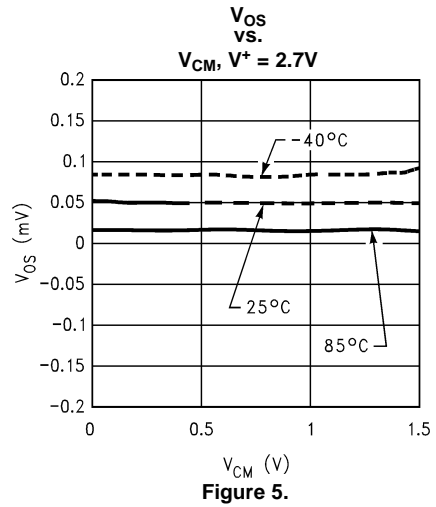
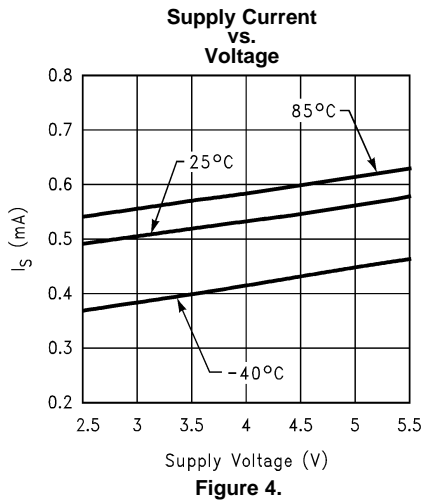

LMV751

SNOS468E –AUGUST 1999–REVISED MARCH 2013

www.ti.com

Typical Performance Characteristics (continued)

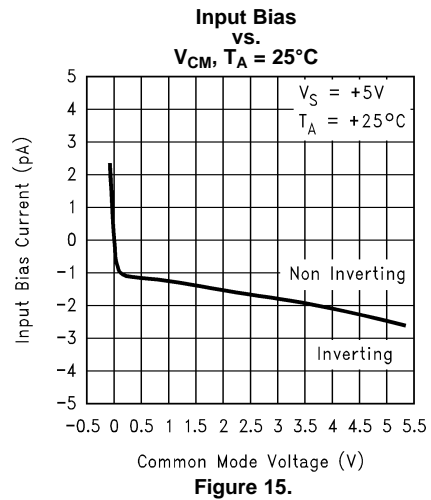
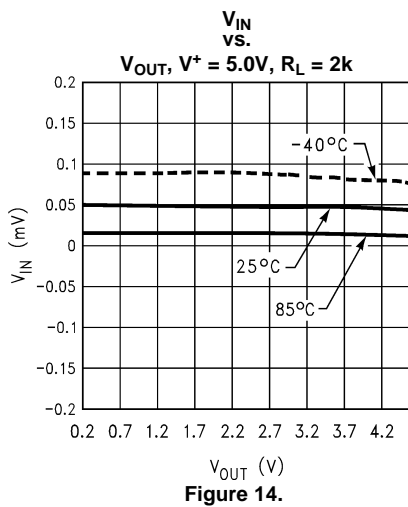
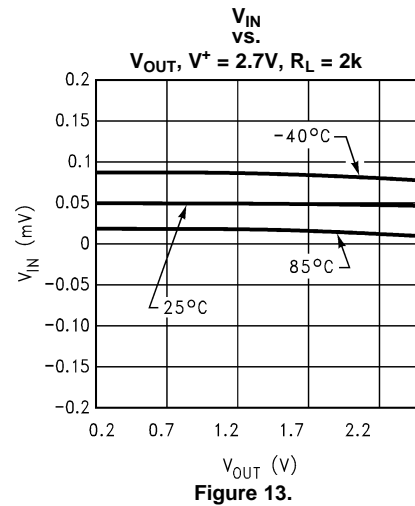
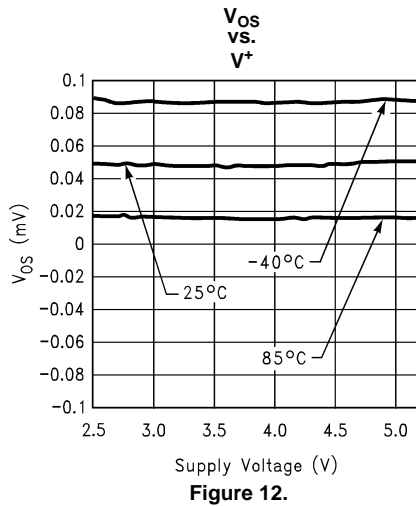
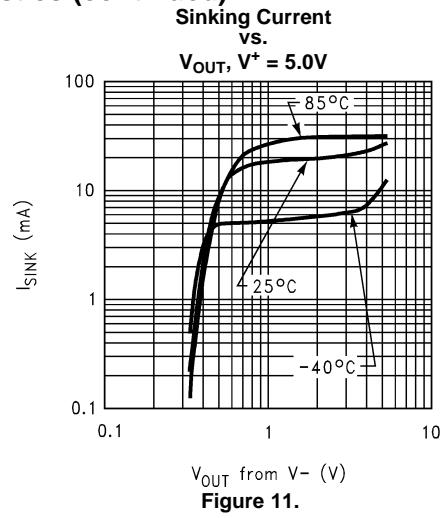
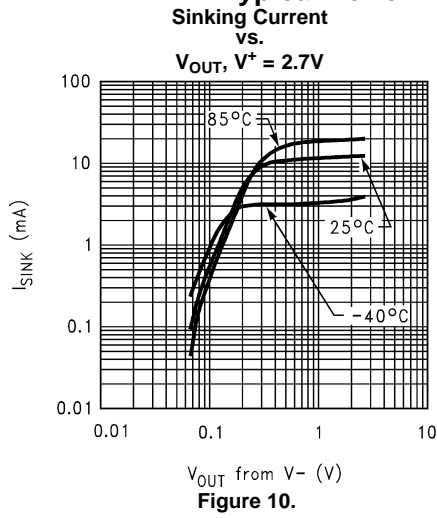

Typical Performance Characteristics (continued)

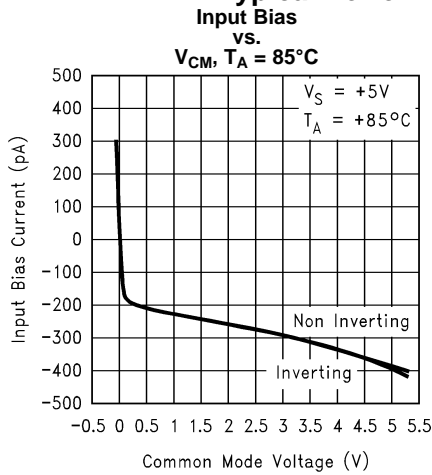

Figure 16.

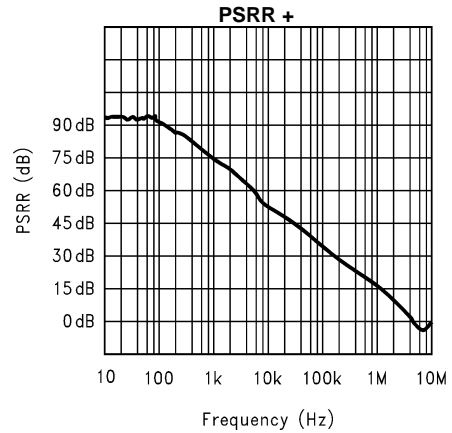

Figure 17.

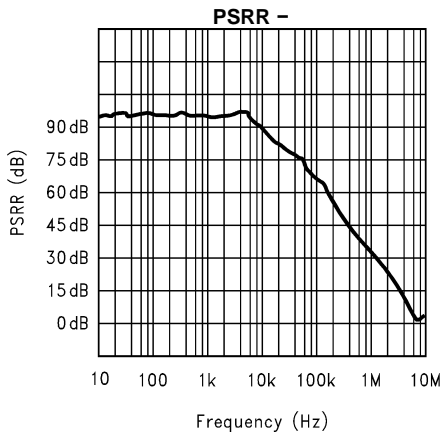

Figure 18.

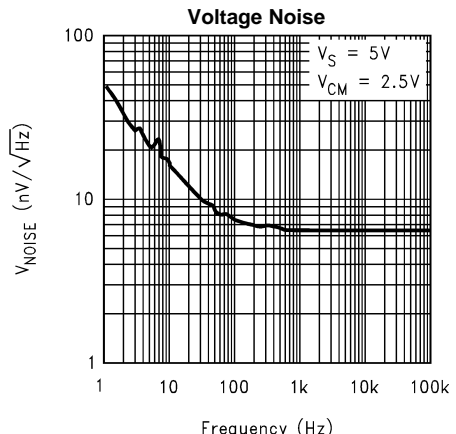

Figure 19.

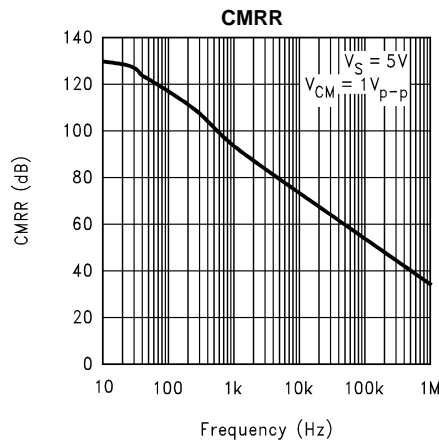

Figure 20.

LMV751

SNOS468E –AUGUST 1999–REVISED MARCH 2013

www.ti.com

APPLICATION HINTS

Noise

There are many sources of noise in a system: thermal noise, shot noise, 1/f, popcorn noise, resistor noise, just to name a few. In addition to starting with a low noise op amp, such as the LMV751, careful attention to detail will result in the lowest overall noise for the system.

To invert or not invert?

Both inverting and non-inverting amplifiers employ feedback to stabilize the closed loop gain of the block being designed. The loop gain (in decibels) equals the algebraic difference between the open loop and closed loop gains. Feedback improves the Total Harmonic Distortion (THD) and the output impedance. The various noise sources, when input referred, are amplified, not by the closed loop gain, but by the noise gain. For a non-inverting amplifier, the noise gain is equal to the closed loop gain, but for an inverting amplifier, the noise gain is equal to the closed loop gain plus one. For large gains, e.g., 100, the difference is negligible, but for small gains, such as one, the noise gain for the inverting amplifier would be two. This implies that non-inverting blocks are preferred at low gains.

Source impedance

Because noise sources are uncorrelated, the system noise is calculated by taking the RMS sum of the various noise sources, that is, the square root of the sum of the squares. At very low source impedances, the voltage noise will dominate; at very high source impedances, the input noise current times the equivalent external resistance will dominate. For a detailed example calculation, refer to [Note 1](#).

Bias current compensation resistor

In CMOS input op amps, the input bias currents are very low, so there is no need to use R_{COMP} (see [Figure 21](#) and [Figure 22](#)) for bias current compensation that would normally be used with early generation bipolar op amps. In fact, inclusion of the resistor would act as another thermal noise source in the system, increasing the overall noise.

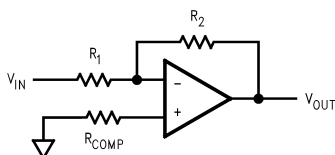

Figure 21. Bias Current Compensation Resistor

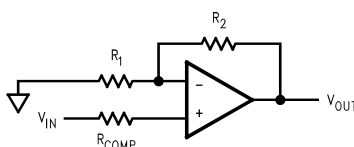

Figure 22. Bias Current Compensation Resistor

Resistor types

Thermal noise is generated by any passive resistive element. This noise is "white"; meaning it has a constant spectral density. Thermal noise can be represented by a mean-square voltage generator e_R^2 in series with a noiseless resistor, where e_R^2 is given by: Where:

$$e_R^2 = 4K TRB \text{ (volts)}^2$$

where

- T = temperature in °K
- R = resistor value in ohms
- B = noise bandwidth in Hz
- K = Boltzmann's constant ($1.38 \times 10^{-23} \text{ W-sec/}^\circ\text{K}$)

(1)

Actual resistor noise measurements may have more noise than the calculated value. This additional noise component is known as excess noise. Excess noise has a $1/f$ spectral response, and is proportional to the voltage drop across the resistor. It is convenient to define a noise index when referring to excess noise in resistors. The noise index is the RMS value in μV of noise in the resistor per volt of DC drop across the resistor in a decade of frequency. Noise index expressed in dB is:

$$\text{NI} = 20 \log ((E_{\text{EX}}/V_{\text{DC}}) \times 10^6) \text{ db}$$

where

- E_{EX} = resistor excess noise in μV per frequency decade
 - V_{DC} = DC voltage drop across the resistor
- (2)

Excess noise in carbon composition resistors corresponds to a large noise index of +10 dB to -20 dB. Carbon film resistors have a noise index of -10 dB to -25 dB. Metal film and wire wound resistors show the least amount of excess noise, with a noise index figure of -15 dB to -40 dB.

Other noise sources:

As the op amp and resistor noise sources are decreased, other noise contributors will now be noticeable. Small air currents across thermocouples will result in low frequency variations. Any two dissimilar metals, such as the lead on the IC and the solder and copper foil of the pc board, will form a thermocouple. The source itself may also generate noise. An example would be a resistive bridge. All resistive sources generate thermal noise based on the same equation listed above under "resistor types". (2)

Putting it all together

To a first approximation, the total input referred noise of an op amp is:

$$E_t^2 = e_n^2 + e_{\text{req}}^2 + (i_n \cdot \text{Req})^2$$

where

- Req is the equivalent source resistance at the inputs
- (3)

At low impedances, voltage noise dominates. At high impedances, current noise dominates. With a typical noise current on most CMOS input op amps of $0.01 \text{ pA}/\sqrt{\text{Hz}}$, the current noise contribution will be smaller than the voltage noise for Req less than one megohm.

Other Considerations

Comparator operation

Occasionally operational amplifiers are used as comparators. This is not optimum for the LMV751 for several reasons. First, the LMV751 is compensated for unity gain stability, so the speed will be less than could be obtained on the same process with a circuit specifically designed for comparator operation. Second, op amp output stages are designed to be linear, and will not necessarily meet the logic levels required under all conditions. Lastly, the LMV751 has the newer PNP-NPN common emitter output stage, characteristic of many rail-to-rail output op amps. This means that when used in open loop applications, such as comparators, with very light loads, the output PNP will saturate, with the output current being diverted into the previous stage. As a result, the supply current will increase to the 20-30 mA. range. When used as a comparator, a resistive load between $2\text{k}\Omega$ and $10\text{k}\Omega$ should be used with a small amount of hysteresis to alleviate this problem. When used as an op amp, the closed loop gain will drive the inverting input to within a few millivolts of the non-inverting input. This will automatically reduce the output drive as the output settles to the correct value; thus it is only when used as a comparator that the current will increase to the tens of milliampere range.

Rail-to-Rail

Because of the output stage discussed above, the LMV751 will swing "rail-to-rail" on the output. This normally means within a few hundred millivolts of each rail with a reasonable load. Referring to the [Electrical Characteristics](#) table for 2.7V to 5.0V, it can be seen that this is true for resistive loads of $2\text{k}\Omega$ and $10\text{k}\Omega$. The input stage consists of cascoded P-channel MOSFETS, so the input common mode range includes ground, but typically requires 1.2V to 1.3V headroom from the positive rail. This is better than the industry standard LM324 and LM358 that have PNP input stages, and the LMV751 has the advantage of much lower input bias currents.

LMV751

SNOS468E – AUGUST 1999 – REVISED MARCH 2013

www.ti.com

Loading

The LMV751 is a low noise, high speed op amp with excellent phase margin and stability. Capacitive loads up to 1000 pF can be handled, but larger capacitive loads should be isolated from the output. The most straightforward way to do this is to put a resistor in series with the output. This resistor will also prevent excess power dissipation if the output is accidentally shorted.

General Circuits

With the low noise and low input bias current, the LMV751 would be useful in active filters, integrators, current to voltage converters, low frequency sine wave generators, and instrumentation amplifiers. (3)



NOTE

1. Sherwin, Jim "Noise Specs Confusing?" AN-104 ([SNVA515](#)), Texas Instruments.
 2. Christensen, John, "Noise-figure curve ease the selection of low-noise op amps", EDN, pp 81-84, Aug. 4, 1994.
 3. "Op Amp Circuit Collection", AN-31 ([SNLA140](#)), Texas Instruments.
-

REVISION HISTORY

Changes from Revision D (March 2013) to Revision E	Page
• Changed layout of National Data Sheet to TI format	10

PACKAGING INFORMATION

Orderable Device	Status (1)	Package Type	Package Drawing	Pins	Package Qty	Eco Plan (2)	Lead/Ball Finish (6)	MSL Peak Temp (3)	Op Temp (°C)	Device Marking (4/5)	Samples
LMV751M5	NRND	SOT-23	DBV	5	1000	TBD	Call TI	Call TI	-40 to 85	A32A	
LMV751M5/NOPB	ACTIVE	SOT-23	DBV	5	1000	Green (RoHS & no Sb/Br)	CU SN	Level-1-260C-UNLIM	-40 to 85	A32A	
LMV751M5X	NRND	SOT-23	DBV	5	3000	TBD	Call TI	Call TI	-40 to 85	A32A	
LMV751M5X/NOPB	ACTIVE	SOT-23	DBV	5	3000	Green (RoHS & no Sb/Br)	CU SN	Level-1-260C-UNLIM	-40 to 85	A32A	

(1) The marketing status values are defined as follows:

ACTIVE: Product device recommended for new designs.

LIFEBUY: TI has announced that the device will be discontinued, and a lifetime-buy period is in effect.

NRND: Not recommended for new designs. Device is in production to support existing customers, but TI does not recommend using this part in a new design.

PREVIEW: Device has been announced but is not in production. Samples may or may not be available.

OBSELETE: TI has discontinued the production of the device.

(2) Eco Plan - The planned eco-friendly classification: Pb-Free (RoHS), Pb-Free (RoHS Exempt), or Green (RoHS & no Sb/Br) - please check <http://www.ti.com/productcontent> for the latest availability information and additional product content details.

TBD: The Pb-Free/Green conversion plan has not been defined.

Pb-Free (RoHS): TI's terms "Lead-Free" or "Pb-Free" mean semiconductor products that are compatible with the current RoHS requirements for all 6 substances, including the requirement that lead not exceed 0.1% by weight in homogeneous materials. Where designed to be soldered at high temperatures, TI Pb-Free products are suitable for use in specified lead-free processes.

Pb-Free (RoHS Exempt): This component has a RoHS exemption for either 1) lead-based flip-chip solder bumps used between the die and package, or 2) lead-based die adhesive used between the die and leadframe. The component is otherwise considered Pb-Free (RoHS compatible) as defined above.

Green (RoHS & no Sb/Br): TI defines "Green" to mean Pb-Free (RoHS compatible), and free of Bromine (Br) and Antimony (Sb) based flame retardants (Br or Sb do not exceed 0.1% by weight in homogeneous material)

(3) MSL, Peak Temp. - The Moisture Sensitivity Level rating according to the JEDEC industry standard classifications, and peak solder temperature.

(4) There may be additional marking, which relates to the logo, the lot trace code information, or the environmental category on the device.

(5) Multiple Device Markings will be inside parentheses. Only one Device Marking contained in parentheses and separated by a "-" will appear on a device. If a line is indented then it is a continuation of the previous line and the two combined represent the entire Device Marking for that device.

(6) Lead/Ball Finish - Orderable Devices may have multiple material finish options. Finish options are separated by a vertical ruled line. Lead/Ball Finish values may wrap to two lines if the finish value exceeds the maximum column width.

Important Information and Disclaimer: The information provided on this page represents TI's knowledge and belief as of the date that it is provided. TI bases its knowledge and belief on information provided by third parties, and makes no representation or warranty as to the accuracy of such information. Efforts are underway to better integrate information from third parties. TI has taken and



Distributor of Texas Instruments: Excellent Integrated System Limited

Datasheet of LMV751M5/NOPB - IC OPAMP GP 5MHZ SOT23-5

Contact us: sales@integrated-circuit.com Website: www.integrated-circuit.com

PACKAGE OPTION ADDENDUM

www.ti.com

1-Nov-2013

continues to take reasonable steps to provide representative and accurate information but may not have conducted destructive testing or chemical analysis on incoming materials and chemicals. TI and TI suppliers consider certain information to be proprietary, and thus CAS numbers and other limited information may not be available for release.

In no event shall TI's liability arising out of such information exceed the total purchase price of the TI part(s) at issue in this document sold by TI to Customer on an annual basis.

TAPE AND REEL INFORMATION

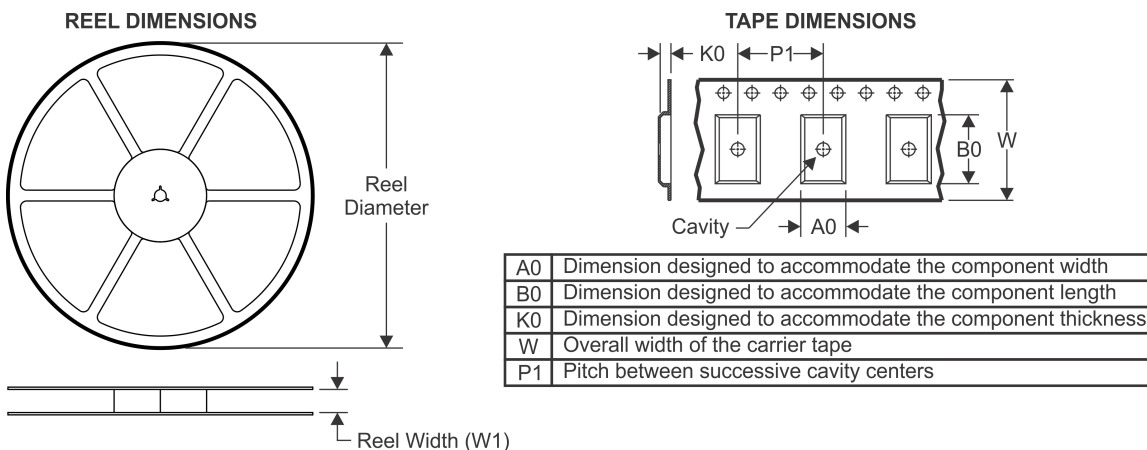

QUADRANT ASSIGNMENTS FOR PIN 1 ORIENTATION IN TAPE

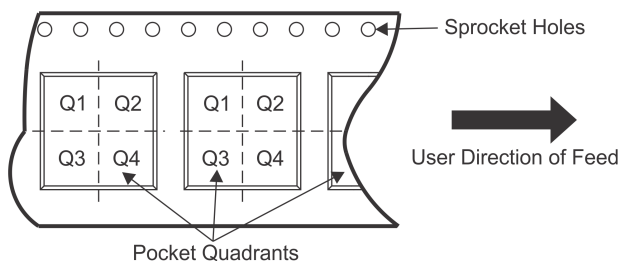

*All dimensions are nominal

Device	Package Type	Package Drawing	Pins	SPQ	Reel Diameter (mm)	Reel Width W1 (mm)	A0 (mm)	B0 (mm)	K0 (mm)	P1 (mm)	W (mm)	Pin1 Quadrant
LMV751M5	SOT-23	DBV	5	1000	178.0	8.4	3.2	3.2	1.4	4.0	8.0	Q3
LMV751M5/NOPB	SOT-23	DBV	5	1000	178.0	8.4	3.2	3.2	1.4	4.0	8.0	Q3
LMV751M5X	SOT-23	DBV	5	3000	178.0	8.4	3.2	3.2	1.4	4.0	8.0	Q3
LMV751M5X/NOPB	SOT-23	DBV	5	3000	178.0	8.4	3.2	3.2	1.4	4.0	8.0	Q3

TAPE AND REEL BOX DIMENSIONS

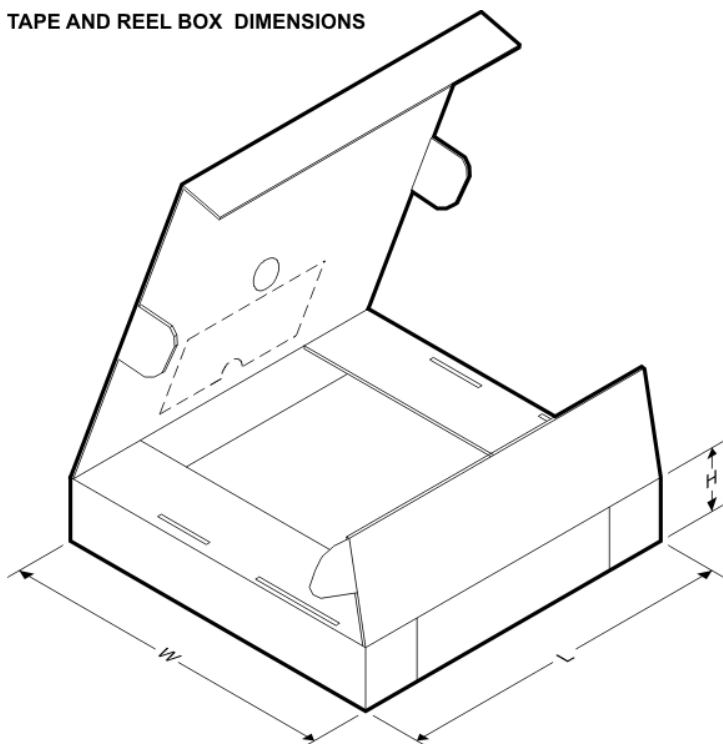

*All dimensions are nominal

Device	Package Type	Package Drawing	Pins	SPQ	Length (mm)	Width (mm)	Height (mm)
LMV751M5	SOT-23	DBV	5	1000	210.0	185.0	35.0
LMV751M5/NOPB	SOT-23	DBV	5	1000	210.0	185.0	35.0
LMV751M5X	SOT-23	DBV	5	3000	210.0	185.0	35.0
LMV751M5X/NOPB	SOT-23	DBV	5	3000	210.0	185.0	35.0

MECHANICAL DATA

DBV (R-PDSO-G5)

PLASTIC SMALL-OUTLINE PACKAGE

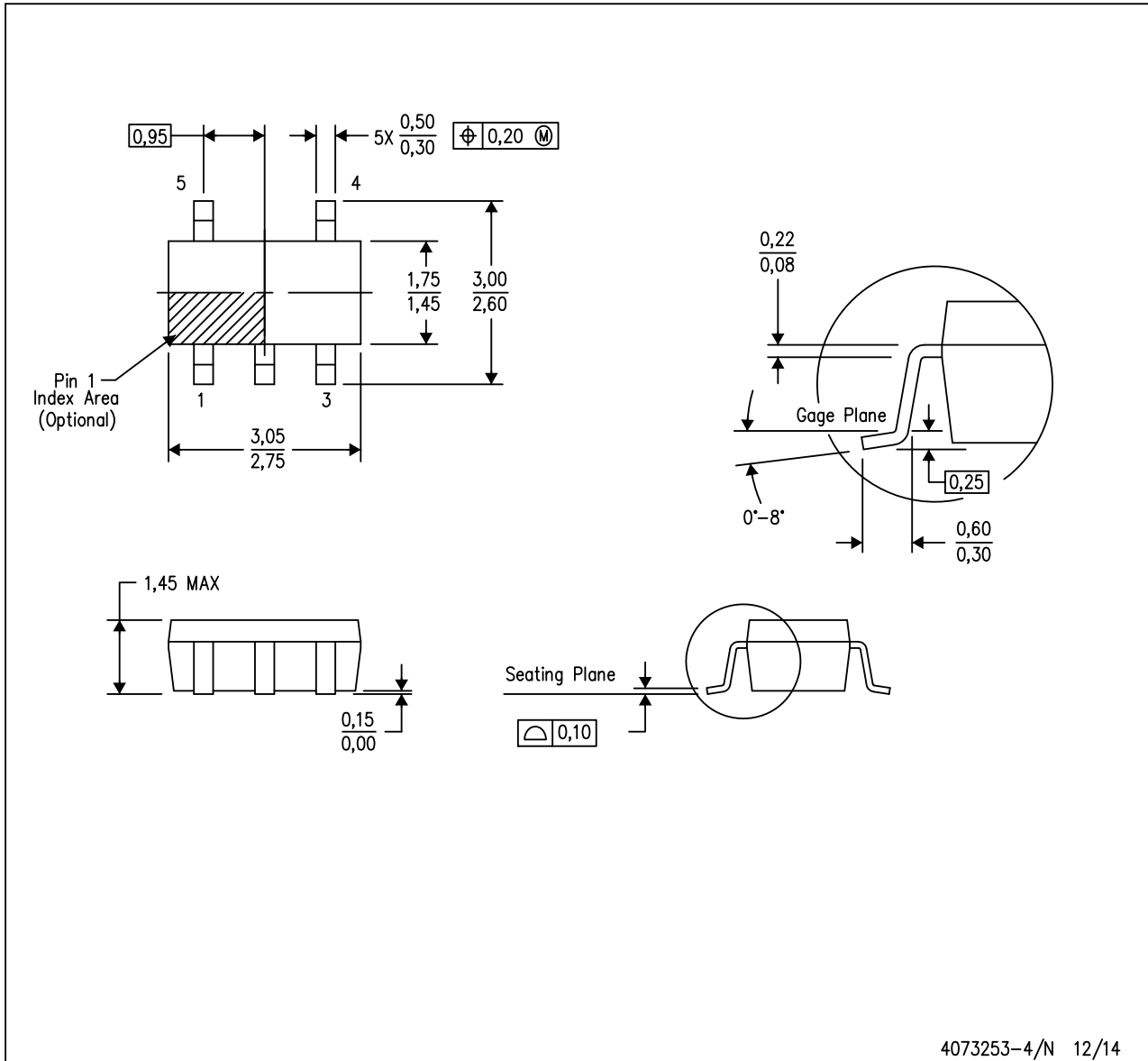

- NOTES:
- A. All linear dimensions are in millimeters.
 - B. This drawing is subject to change without notice.
 - C. Body dimensions do not include mold flash or protrusion. Mold flash and protrusion shall not exceed 0.15 per side.
 - D. Falls within JEDEC MO-178 Variation AA.

LAND PATTERN DATA

DBV (R-PDSO-G5)

PLASTIC SMALL OUTLINE

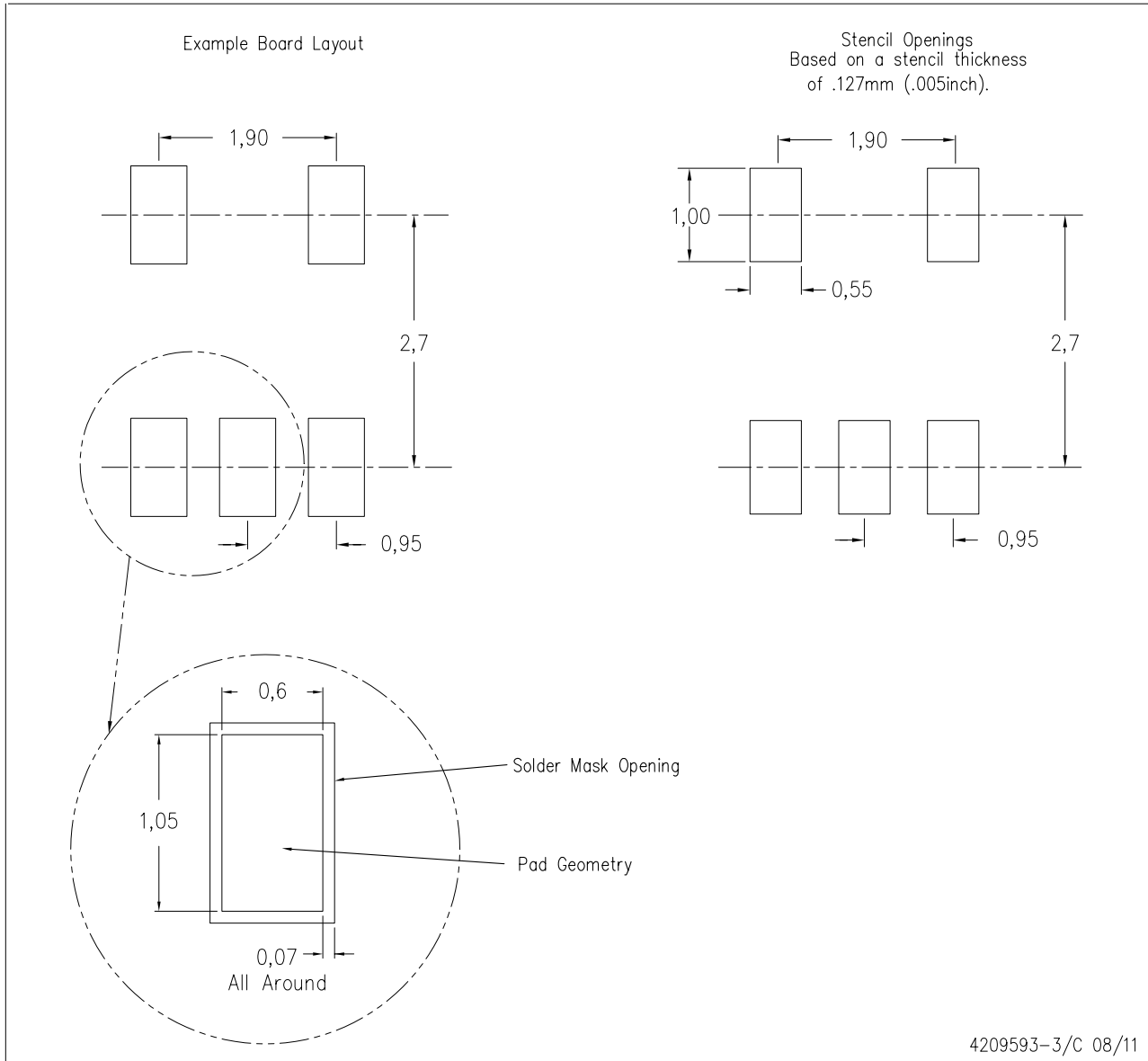

- NOTES:
- A. All linear dimensions are in millimeters.
 - B. This drawing is subject to change without notice.
 - C. Customers should place a note on the circuit board fabrication drawing not to alter the center solder mask defined pad.
 - D. Publication IPC-7351 is recommended for alternate designs.
 - E. Laser cutting apertures with trapezoidal walls and also rounding corners will offer better paste release. Customers should contact their board assembly site for stencil design recommendations. Example stencil design based on a 50% volumetric metal load solder paste. Refer to IPC-7525 for other stencil recommendations.

IMPORTANT NOTICE

Texas Instruments Incorporated and its subsidiaries (TI) reserve the right to make corrections, enhancements, improvements and other changes to its semiconductor products and services per JESD46, latest issue, and to discontinue any product or service per JESD48, latest issue. Buyers should obtain the latest relevant information before placing orders and should verify that such information is current and complete. All semiconductor products (also referred to herein as “components”) are sold subject to TI’s terms and conditions of sale supplied at the time of order acknowledgment.

TI warrants performance of its components to the specifications applicable at the time of sale, in accordance with the warranty in TI’s terms and conditions of sale of semiconductor products. Testing and other quality control techniques are used to the extent TI deems necessary to support this warranty. Except where mandated by applicable law, testing of all parameters of each component is not necessarily performed.

TI assumes no liability for applications assistance or the design of Buyers’ products. Buyers are responsible for their products and applications using TI components. To minimize the risks associated with Buyers’ products and applications, Buyers should provide adequate design and operating safeguards.

TI does not warrant or represent that any license, either express or implied, is granted under any patent right, copyright, mask work right, or other intellectual property right relating to any combination, machine, or process in which TI components or services are used. Information published by TI regarding third-party products or services does not constitute a license to use such products or services or a warranty or endorsement thereof. Use of such information may require a license from a third party under the patents or other intellectual property of the third party, or a license from TI under the patents or other intellectual property of TI.

Reproduction of significant portions of TI information in TI data books or data sheets is permissible only if reproduction is without alteration and is accompanied by all associated warranties, conditions, limitations, and notices. TI is not responsible or liable for such altered documentation. Information of third parties may be subject to additional restrictions.

Resale of TI components or services with statements different from or beyond the parameters stated by TI for that component or service voids all express and any implied warranties for the associated TI component or service and is an unfair and deceptive business practice. TI is not responsible or liable for any such statements.

Buyer acknowledges and agrees that it is solely responsible for compliance with all legal, regulatory and safety-related requirements concerning its products, and any use of TI components in its applications, notwithstanding any applications-related information or support that may be provided by TI. Buyer represents and agrees that it has all the necessary expertise to create and implement safeguards which anticipate dangerous consequences of failures, monitor failures and their consequences, lessen the likelihood of failures that might cause harm and take appropriate remedial actions. Buyer will fully indemnify TI and its representatives against any damages arising out of the use of any TI components in safety-critical applications.

In some cases, TI components may be promoted specifically to facilitate safety-related applications. With such components, TI’s goal is to help enable customers to design and create their own end-product solutions that meet applicable functional safety standards and requirements. Nonetheless, such components are subject to these terms.

No TI components are authorized for use in FDA Class III (or similar life-critical medical equipment) unless authorized officers of the parties have executed a special agreement specifically governing such use.

Only those TI components which TI has specifically designated as military grade or “enhanced plastic” are designed and intended for use in military/aerospace applications or environments. Buyer acknowledges and agrees that any military or aerospace use of TI components which have **not** been so designated is solely at the Buyer’s risk, and that Buyer is solely responsible for compliance with all legal and regulatory requirements in connection with such use.

TI has specifically designated certain components as meeting ISO/TS16949 requirements, mainly for automotive use. In any case of use of non-designated products, TI will not be responsible for any failure to meet ISO/TS16949.

Products

Audio	www.ti.com/audio
Amplifiers	amplifier.ti.com
Data Converters	dataconverter.ti.com
DLP® Products	www.dlp.com
DSP	dsp.ti.com
Clocks and Timers	www.ti.com/clocks
Interface	interface.ti.com
Logic	logic.ti.com
Power Mgmt	power.ti.com
Microcontrollers	microcontroller.ti.com
RFID	www.ti-rfid.com
OMAP Applications Processors	www.ti.com/omap
Wireless Connectivity	www.ti.com/wirelessconnectivity

Applications

Automotive and Transportation	www.ti.com/automotive
Communications and Telecom	www.ti.com/communications
Computers and Peripherals	www.ti.com/computers
Consumer Electronics	www.ti.com/consumer-apps
Energy and Lighting	www.ti.com/energy
Industrial	www.ti.com/industrial
Medical	www.ti.com/medical
Security	www.ti.com/security
Space, Avionics and Defense	www.ti.com/space-avionics-defense
Video and Imaging	www.ti.com/video

TI E2E Community

e2e.ti.com