



Distributor of ITT Cannon, LLC: Excellent Integrated System Limited

Datasheet of KPT07F8-2P - CONN RCPT 2POS JAM NUT PIN

Contact us: sales@integrated-circuit.com Website: www.integrated-circuit.com

Excellent Integrated System Limited

Stocking Distributor

Click to view price, real time Inventory, Delivery & Lifecycle Information:

[ITT Cannon, LLC](#)
[KPT07F8-2P](#)

For any questions, you can email us directly:

sales@integrated-circuit.com

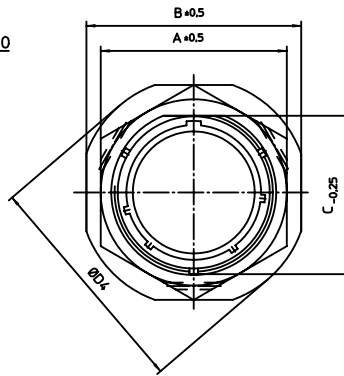
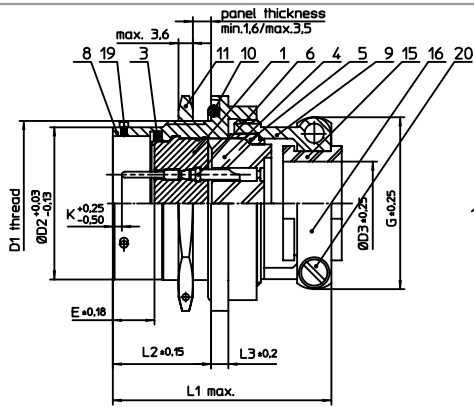

NO.	MASSE / DIMENSION
A	19
B	24
C	13.45
D1	9/16-24UNEF-2A
D2	12
D3	3.2
D4	28
E	8.25
K	2.16
L1	45.2
L2	17.7
L3	3.2

NO.	BESCHREIBUNG / DESCRIPTION
1	ISOLIERKÖRPER STIFT / INSULATOR PIN
3	DICHTRING / GASKET
4	DICHTKÖRPER / GROMMET
5	ENDRING / ENDRING
6	KONTAKT STIFT / CONTACT PIN
8	GEHÄUSE / RECEPTACLE
9	ENDGEHÄUSE / ENDBELL
10	O-RING / O-RING
11	SECHSKANTMUTTER / HEX NUT
15	KABELTÜLLE / BUSHING
16	KABELKLEMME / CABLE CLAMP
19	BAYONETTSTIFT / BAYONET PIN
20	ZYLINDER-SCHRAUBE / CYLINDER HEAD SCREW

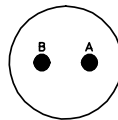

Note: Due to an automatic nomenclature system, numbers generated may not be sequential.
Specification and Dimensions subject to change
Drawings illustrate normal insulator positioning

Material Specification:	
Shell Material:	Aluminium alloy
Shell Plating:	Olive drab chromate over cadmium plating
Insulator Material:	Polychloroprene
Contact Material:	Copper alloy, gold plated
Contact Plating:	Copper alloy, gold plated

all dimensions are in mm
Dimensions without tolerance indications are general tolerances in acc. with DIN7168m

drawing for
CUSTOMER



description KPT07F82P
Jam nut receptacle
Grommet seal with strain relief
Solder Cup / Pin / Layout: 8-2

© All rights reserved. Reproduction or issue to third in any form without is only permitted with written authorization of ITT Cannon



page 1/1
revision 1013.5. Jul 16