



Distributor of Texas Instruments: Excellent Integrated System Limited

Datasheet of LP2956AIM/NOPB - IC REG LDO ADJ 0.25A 16SOIC

Contact us: sales@integrated-circuit.com Website: www.integrated-circuit.com

Excellent Integrated System Limited

Stocking Distributor

Click to view price, real time Inventory, Delivery & Lifecycle Information:

[Texas Instruments](#)
[LP2956AIM/NOPB](#)

For any questions, you can email us directly:

sales@integrated-circuit.com

LP2956/LP2956A Dual Micropower Low-Dropout Voltage Regulators

Check for Samples: [LP2956](#), [LP2956A](#)

FEATURES

- Output Voltage Adjusts From 1.23V to 29V
- Ensured 250 mA Current (Main Output)
- Auxiliary LDO (75 mA) Adjustable Output
- Auxiliary Comparator With Open-Collector Output
- Shutdown Pin for Main Output
- Extremely Low Quiescent Current
- Low Dropout Voltage
- Extremely Tight Line and Load Regulation
- Very Low Temperature Coefficient
- Current and Thermal Limiting
- Reverse Battery Protection

APPLICATIONS

- High-Efficiency Linear Regulator
- Low Dropout Battery-Powered Regulator
- μ P System Regulator With Switchable High-Current V_{CC}

DESCRIPTION

The LP2956 is a micropower voltage regulator with very low quiescent current (170 μ A typical at light loads) and very low dropout voltage (typically 60 mV at 1 mA load current and 470 mV at 250 mA load current on the main output).

The LP2956 retains all the desirable characteristics of the LP2951, but offers increased output current (main output), an auxiliary LDO adjustable regulated output (75 mA), and additional features.

The auxiliary output is always on (regardless of main output status), so it can be used to power memory circuits.

Quiescent current increases only slightly at dropout, which prolongs battery life.

The error flag goes low if the main output voltage drops out of regulation.

An open-collector auxiliary comparator is included, whose inverting input is tied to the 1.23V reference.

Reverse battery protection is provided.

The parts are available in DIP and surface mount packages.

BLOCK DIAGRAM

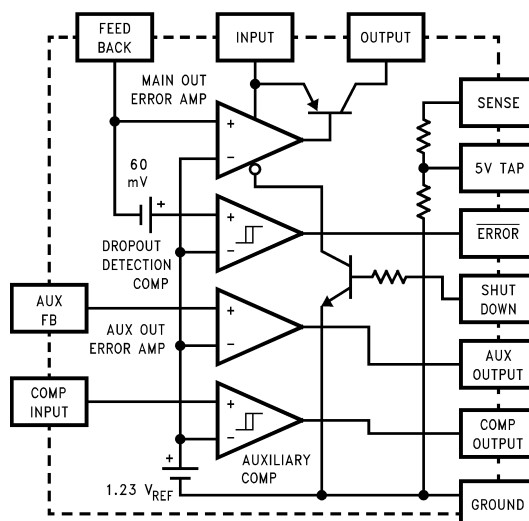

Figure 1. LP2956



Please be aware that an important notice concerning availability, standard warranty, and use in critical applications of Texas Instruments semiconductor products and disclaimers thereto appears at the end of this data sheet.

All trademarks are the property of their respective owners.

LP2956, LP2956A

SNVS101E –MAY 1999–REVISED APRIL 2013

www.ti.com

CONNECTION DIAGRAM

16-Pin PDIP and CDIP

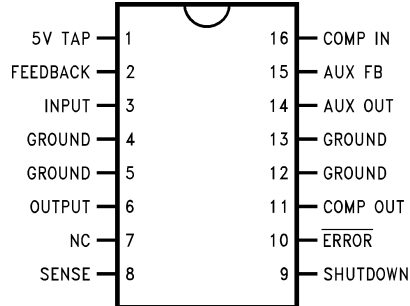

**Figure 2. See Package Number N16A
See Package Number NFE**

16-Pin Surface Mount SOIC

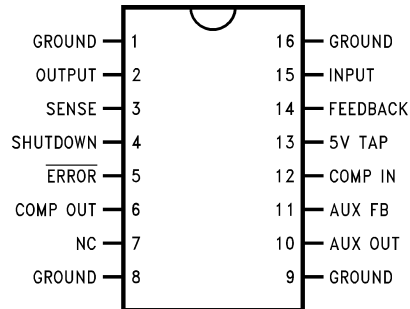

Figure 3. See Package Number D



These devices have limited built-in ESD protection. The leads should be shorted together or the device placed in conductive foam during storage or handling to prevent electrostatic damage to the MOS gates.

ABSOLUTE MAXIMUM RATINGS⁽¹⁾⁽²⁾

Storage Temperature Range	-65°C to +150°C
Operating Junction Temperature Range	-40°C to +125°C
Lead Temperature (Soldering, 5 seconds)	260°C
Power Dissipation ⁽³⁾	Internally Limited
Input Supply Voltage	-20V to +30V
Feedback Input Voltage ⁽⁴⁾	-0.3V to +5V
Aux. Feedback Input Voltage ⁽⁴⁾	-0.3V to +5V
Shutdown Input Voltage ⁽⁴⁾	-0.3V to +30V
Comparator Input Voltage ^{(4) (5)}	-0.3V to +30V
Comparator Output Voltage ^{(4) (5)}	-0.3V to +30V
ESD Rating ⁽⁶⁾	2 kV

- (1) Absolute maximum ratings indicate limits beyond which damage to the component may occur. Electrical specifications do not apply when operating the device outside of its rated operating conditions.
- (2) If Military/Aerospace specified devices are required, please contact the Texas Instruments Sales Office/Distributors for availability and specifications.
- (3) The maximum allowable power dissipation is a function of the maximum junction temperature, $T_{J(max)}$, the junction-to-ambient thermal resistance, θ_{J-A} , and the ambient temperature, T_A . The maximum allowable power dissipation at any ambient temperature is calculated using: $P(max) = \frac{T_{J(max)} - T_A}{\theta_{J-A}}$. Exceeding the maximum allowable power dissipation will cause excessive die temperature, and the regulator will go into thermal shutdown. See Application Hints for additional information on heat sinking and thermal resistance.
- (4) When used in dual-supply systems where the regulator load is returned to a negative supply, the output voltage must be diode-clamped to ground.
- (5) May exceed the input supply voltage.
- (6) All pins are rated for 2 kV, except for the auxiliary feedback pin which is rated for 1.2 kV (human body model, 100 pF discharged through 1.5 kΩ).

ELECTRICAL CHARACTERISTICS

Limits in standard typeface are for $T_J = 25^\circ\text{C}$, and limits in **boldface type** apply over the full operating temperature range. Limits are specified by production testing or correlation techniques using standard Statistical Quality Control (SQC) methods. Unless otherwise specified: $V_{IN} = 6\text{V}$, $C_L = 2.2\ \mu\text{F}$ (Main Output) and $10\ \mu\text{F}$ (Auxiliary Output), Feedback pin is tied to 5V Tap pin, $C_{IN} = 1\ \mu\text{F}$, $V_{SD} = 0\text{V}$, Main Output pin is tied to Output Sense pin, Auxiliary Output is programmed for 5V. The main regulator output has a 1 mA load, the auxiliary regulator output has a 100 μA load.

Symbol	Parameter	Conditions	Typical	LP2956AI		LP2956I		Units
				Min	Max	Min	Max	
MAIN OUTPUT								
V_O	Output Voltage		5.0	4.975	5.025	4.950	5.050	V
		$1\ \text{mA} \leq I_L \leq 250\ \text{mA}$	5.0	4.940	5.060	4.900	5.100	
$\Delta V_O/\Delta T$	Temperature Coefficient	⁽¹⁾	20		100		150	ppm/°C
$\Delta V_O/V_O$	Line Regulation	$V_{IN} = 6\text{V to }30\text{V}$	0.03		0.1		0.2	%
					0.2		0.4	
$\Delta V_O/V_O$	Load Regulation	$I_L = 1\ \text{mA to }250\ \text{mA}$	0.04		0.16		0.20	%
		$I_L = 0.1\ \text{mA to }1\ \text{mA}$ ⁽²⁾			0.20		0.30	

- (1) Output or reference voltage temperature coefficient is defined as the worst case voltage change divided by the total temperature range.
- (2) Load regulation is measured at constant junction temperature using low duty cycle pulse testing. Two separate tests are performed, one for the range of 100 μA to 1 mA and one for the 1 mA to 250 mA range. Changes in output voltage due to heating effects are covered by the thermal regulation specification.

LP2956, LP2956A

SNVS101E –MAY 1999–REVISED APRIL 2013

www.ti.com
ELECTRICAL CHARACTERISTICS (continued)

Limits in standard typeface are for $T_J = 25^\circ\text{C}$, and limits in **boldface type** apply over the full operating temperature range. Limits are specified by production testing or correlation techniques using standard Statistical Quality Control (SQC) methods. Unless otherwise specified: $V_{IN} = 6\text{V}$, $C_L = 2.2\ \mu\text{F}$ (Main Output) and $10\ \mu\text{F}$ (Auxiliary Output), Feedback pin is tied to 5V Tap pin, $C_{IN} = 1\ \mu\text{F}$, $V_{SD} = 0\text{V}$, Main Output pin is tied to Output Sense pin, Auxiliary Output is programmed for 5V. The main regulator output has a 1 mA load, the auxiliary regulator output has a 100 μA load.

Symbol	Parameter	Conditions	Typical	LP2956AI		LP2956I		Units
				Min	Max	Min	Max	
$V_{IN}-V_O$	Dropout Voltage ⁽³⁾	$I_L = 1\ \text{mA}$	60		100		100	mV
					150		150	
		$I_L = 50\ \text{mA}$	240		300		300	
					420		420	
		$I_L = 100\ \text{mA}$	310		400		400	
$I_L = 250\ \text{mA}$		470		600		600		
				800		800		
I_{LIMIT}	Current Limit	$R_L = 1\ \Omega$	380		500		500	mA
					530		530	
$\Delta V_O/\Delta P_D$	Thermal Regulation	⁽⁴⁾	0.05		0.2		0.2	%/W
e_n	Output Noise Voltage (10 Hz to 100 KHz) $I_L = 100\ \text{mA}$	$C_L = 2.2\ \mu\text{F}$	400					$\mu\text{V RMS}$
		$C_L = 33\ \mu\text{F}$	260					
		$C_L = 33\ \mu\text{F}$ ⁽⁵⁾	80					
V_{FB}	Feedback Pin Voltage		1.23	1.215	1.245	1.205	1.255	V
I_{FB}	Feedback Pin Bias Current		20		40		40	nA
					60		60	
I_O (OFF)	Output Leakage In Shutdown	$I_{(SD\ IN)} \geq 1\ \mu\text{A}$ $V_{IN} = 30\text{V}$, $V_{OUT} = 0\text{V}$	3		10		10	μA
					20		20	
AUXILIARY OUTPUT								
V_{FB}	Feedback Pin Voltage		1.23	1.22	1.25	1.21	1.26	V
				1.21	1.26	1.20	1.27	
$\Delta V_{FB}/\Delta T$	Feedback Voltage Temperature Coefficient		20					ppm/°C
I_{FB}	Feedback Pin Bias Current		10		20		20	nA
					30		30	
$\Delta V_O/V_O$	Line Regulation	$6\text{V} \leq V_{IN} \leq 30\text{V}$	0.07		0.3		0.4	%
					0.5		0.6	
$\Delta V_O/V_O$	Load Regulation	$I_L = 0.1\ \text{mA to } 1\ \text{mA}$	0.1		0.3		0.4	%
		$I_L = 1\ \text{mA to } 75\ \text{mA}$ ⁽⁶⁾			0.6		1.0	

- (3) Dropout voltage is defined as the input to output differential at which the output voltage drops 100 mV below the value measured with a 1V differential. At very low values of programmed output voltage, the input voltage minimum of 2V (2.3V over temperature) must be observed.
- (4) Thermal regulation is the change in output voltage at a time T after a change in power dissipation, excluding load or line regulation effects. Specifications are for a 200 mA load pulse at $V_{IN} = 20\text{V}$ (3W pulse) for T = 10 ms on the Main regulator output. For the Auxiliary regulator output, specifications are for a 66 mA load pulse at $V_{IN} = 20\text{V}$ (1W pulse) for T = 10 ms.
- (5) Connect a 0.1 μF capacitor from the output to the feedback pin.
- (6) Load regulation is measured at constant junction temperature using low duty cycle pulse testing. Two separate tests are performed, one for the range of 100 μA to 1 mA and one for the 1 mA to 75 mA range. Changes in output voltage due to heating effects are covered by the thermal regulation specification.

ELECTRICAL CHARACTERISTICS (continued)

Limits in standard typeface are for $T_J = 25^\circ\text{C}$, and limits in **boldface type** apply over the full operating temperature range. Limits are specified by production testing or correlation techniques using standard Statistical Quality Control (SQC) methods. Unless otherwise specified: $V_{IN} = 6\text{V}$, $C_L = 2.2\ \mu\text{F}$ (Main Output) and $10\ \mu\text{F}$ (Auxiliary Output), Feedback pin is tied to 5V Tap pin, $C_{IN} = 1\ \mu\text{F}$, $V_{SD} = 0\text{V}$, Main Output pin is tied to Output Sense pin, Auxiliary Output is programmed for 5V. The main regulator output has a 1 mA load, the auxiliary regulator output has a 100 μA load.

Symbol	Parameter	Conditions	Typical	LP2956AI		LP2956I		Units
				Min	Max	Min	Max	
$V_{IN}-V_O$	Dropout Voltage	$I_L = 1\ \text{mA}$	100		200		200	mV
				300		300		
		$I_L = 50\ \text{mA}$	400		600		600	mV
				700		700		
		$I_L = 75\ \text{mA}$	500		700		700	mV
				850		850		
e_n	Output Noise (10 Hz–100 KHz)	$C_L = 10\ \mu\text{F}$	300					$\mu\text{V RMS}$
		$C_L = 33\ \mu\text{F}^{(7)}$ $I_L = 10\ \text{mA}$	100					
I_{LIM}	Current Limit	$V_{OUT} = 0\text{V}^{(8)}$	80	200		200		mA
				250		250		
$\Delta V_O/\Delta P_D$	Thermal Regulation	⁽⁹⁾	0.2		0.5		0.5	%/W
DROPOUT DETECTION COMPARATOR								
I_{OH}	Output "HIGH" Leakage	$V_{OH} = 30\text{V}$	0.01		1		1	μA
				2		2		
V_{OL}	Output "LOW" Voltage	$V_{IN} = 4\text{V}$ $I_O (\text{COMP}) = 400\ \mu\text{A}$	150		250		250	mV
				400		400		
$V_{THR} (\text{max})$	Upper Threshold Voltage	⁽¹⁰⁾	-240	-320	-150	-320	-150	mV
				-380	-100	-380	-100	
$V_{THR} (\text{min})$	Lower Threshold Voltage	⁽¹⁰⁾	-350	-450	-230	-450	-230	mV
				-640	-160	-640	-160	
HYST	Hysteresis	⁽¹⁰⁾	110					mV
SHUTDOWN INPUT								
I_{IN}	Input Current to Disable Output	⁽¹¹⁾	0.03		0.5		0.5	μA
V_{IH}	Shutdown Input High Threshold	$I_{(SD\ IN)} \geq 1\ \mu\text{A}$		900		900		mV
				1200		1200		
V_{IL}	Shutdown Input Low Threshold	$V_O \geq 4.5\text{V}$			400		400	mV
				200		200		
AUXILIARY COMPARATOR								
$V_T(\text{high})$	Upper Trip Point	⁽¹²⁾	1.236	1.20	1.28	1.20	1.28	V
			1.19	1.29	1.19	1.29		
$V_T(\text{low})$	Lower Trip Point	⁽¹²⁾	1.230	1.19	1.27	1.19	1.27	V
			1.18	1.28	1.18	1.28		

(7) Connect a 0.1 μF capacitor from the output to the feedback pin.

(8) The auxiliary regulator output has foldback limiting, which means the output current reduces with output voltage. The tested limit is for $V_{OUT} = 0\text{V}$, so the output current will be higher at higher output voltages.

(9) Thermal regulation is the change in output voltage at a time T after a change in power dissipation, excluding load or line regulation effects. Specifications are for a 200 mA load pulse at $V_{IN} = 20\text{V}$ (3W pulse) for T = 10 ms on the Main regulator output. For the Auxiliary regulator output, specifications are for a 66 mA load pulse at $V_{IN} = 20\text{V}$ (1W pulse) for T = 10 ms.

(10) Dropout detection comparator thresholds are expressed as changes in a 5V output. To express the threshold voltages in terms of a differential at the Feedback terminal, divide by the error amplifier gain = V_{OUT}/V_{REF} .

(11) The shutdown input equivalent circuit is the base of a grounded-emitter NPN transistor in series with a current-limiting resistor. Pulling the shutdown input high turns off the main regulator. For more details, see Application Hints.

(12) This test is performed with the auxiliary comparator output sinking 400 μA of current. At the upper trip point, the comparator output must be $\geq 2.4\text{V}$. At the low trip point, the comparator output must be $\leq 0.4\text{V}$.

LP2956, LP2956A

SNVS101E –MAY 1999–REVISED APRIL 2013

www.ti.com
ELECTRICAL CHARACTERISTICS (continued)

Limits in standard typeface are for $T_J = 25^\circ\text{C}$, and limits in **boldface type** apply over the full operating temperature range. Limits are specified by production testing or correlation techniques using standard Statistical Quality Control (SQC) methods. Unless otherwise specified: $V_{IN} = 6\text{V}$, $C_L = 2.2\ \mu\text{F}$ (Main Output) and $10\ \mu\text{F}$ (Auxiliary Output), Feedback pin is tied to 5V Tap pin, $C_{IN} = 1\ \mu\text{F}$, $V_{SD} = 0\text{V}$, Main Output pin is tied to Output Sense pin, Auxiliary Output is programmed for 5V. The main regulator output has a 1 mA load, the auxiliary regulator output has a $100\ \mu\text{A}$ load.

Symbol	Parameter	Conditions	Typical	LP2956AI		LP2956I		Units
				Min	Max	Min	Max	
HYST	Hysteresis		6					mV
I_{OH}	Output "HIGH" Leakage	$V_{OH} = 30\text{V}$ $V_{IN}(\text{COMP}) = 1.3\text{V}$	0.01		1		1	μA
					2		2	
V_{OL}	Output "LOW" Voltage	$V_{IN}(\text{COMP}) = 1.1\text{V}$ $I_O(\text{COMP}) = 400\ \mu\text{A}$	150		250		250	mV
					400		400	
I_B	Input Bias Current	$0 \leq V_{IN}(\text{COMP}) \leq 5\text{V}$	10	-30	30	-30	30	nA
				-50	50	-50	50	
GROUND PIN CURRENT								
I_{GND}	Ground Pin Current ⁽¹³⁾	$I_L(\text{Main Out}) = 1\ \text{mA}$	170		250		250	μA
		$I_L(\text{Aux. Out}) = 0.1\ \text{mA}$			280		280	
		$I_L(\text{Main Out}) = 50\ \text{mA}$	1.1		2		2	mA
		$I_L(\text{Aux. Out}) = 1\ \text{mA}$			2.5		2.5	
		$I_L(\text{Main Out}) = 100\ \text{mA}$	3		6		6	
		$I_L(\text{Aux. Out}) = 1\ \text{mA}$			8		8	
		$I_L(\text{Main Out}) = 250\ \text{mA}$	16		28		28	
		$I_L(\text{Aux. Out}) = 1\ \text{mA}$			33		33	
		$I_L(\text{Main Out}) = 1\ \text{mA}$	3		6		6	
		$I_L(\text{Aux. Out}) = 50\ \text{mA}$			8		8	
			6		8		8	
					10		10	
I_{GND}	Ground Pin Current at Dropout ⁽¹³⁾	$V_{IN} = 4.5\text{V}$			325		325	μA
		$I_L(\text{Main Out}) = 0.1\ \text{mA}$ $I_L(\text{Aux. Out}) = 0.1\ \text{mA}$	270		350		350	
I_{GND}	Ground Pin Current at Shutdown ⁽¹³⁾	No Load on Either Output	120		180		180	
		$I_{(SD\ IN)} \geq 1\ \mu\text{A}$			200		200	

(13) Ground pin current is the regulator quiescent current. The total current drawn from the source is the sum of the ground pin current, output load current, and current through the external resistive dividers (if used).

Typical Performance Characteristics

Unless otherwise specified: $V_{IN} = 6V$, $C_L = 2.2 \mu F$ (Main Output) and $10 \mu F$ (Auxiliary Output), Feedback is tied to 5V Tap pin, $C_{IN} = 1 \mu F$, $V_{SD} = 0V$, Main Output pin is tied to Output Sense pin, Auxiliary Output is programmed for 5V. The main regulator output has a 1 mA load, the auxiliary output has a 100 μA load.

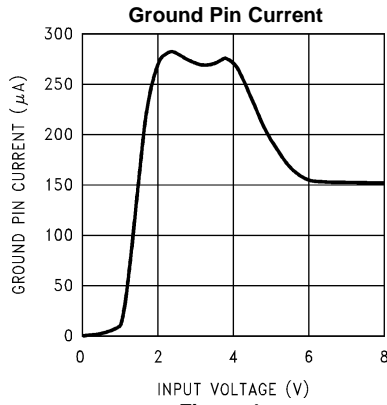

Figure 4.

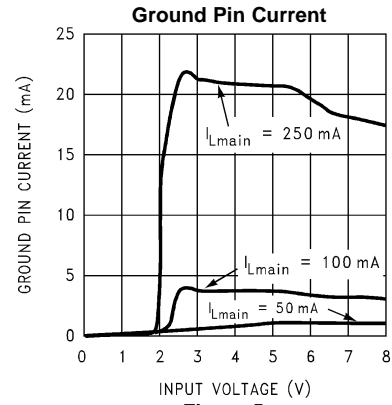

Figure 5.

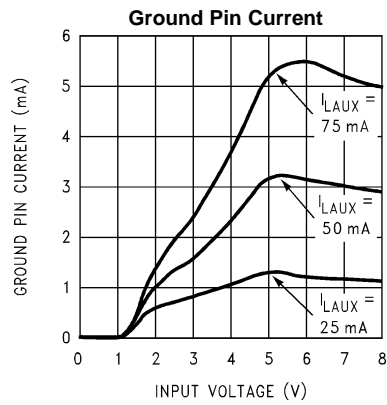

Figure 6.

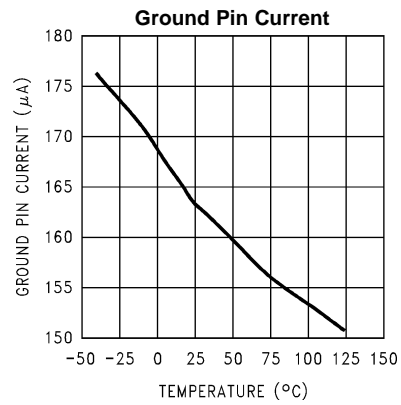

Figure 7.

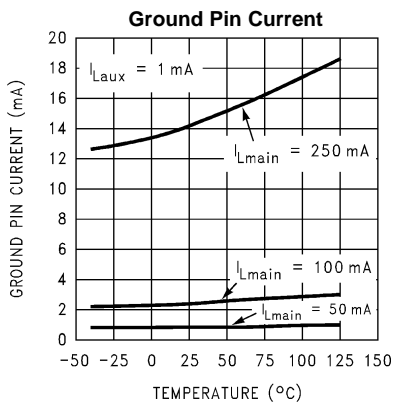

Figure 8.

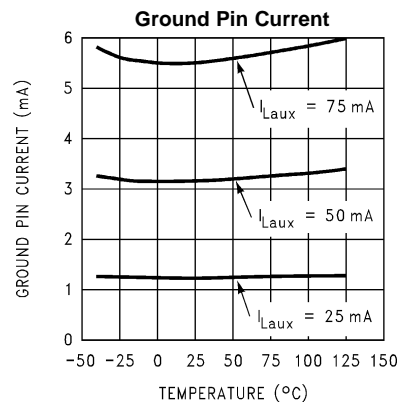

Figure 9.

LP2956, LP2956A

SNVS101E –MAY 1999–REVISED APRIL 2013

www.ti.com

Typical Performance Characteristics (continued)

Unless otherwise specified: $V_{IN} = 6V$, $C_L = 2.2 \mu F$ (Main Output) and $10 \mu F$ (Auxiliary Output), Feedback is tied to 5V Tap pin, $C_{IN} = 1 \mu F$, $V_{SD} = 0V$, Main Output pin is tied to Output Sense pin, Auxiliary Output is programmed for 5V. The main regulator output has a 1 mA load, the auxiliary output has a 100 μA load.

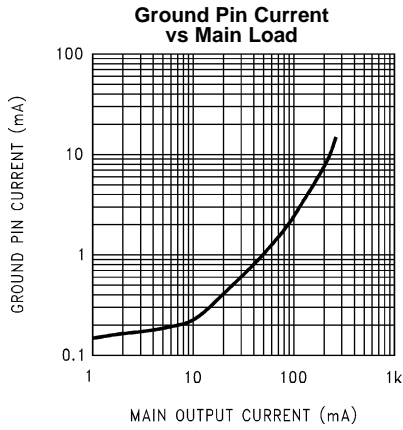

Figure 10.

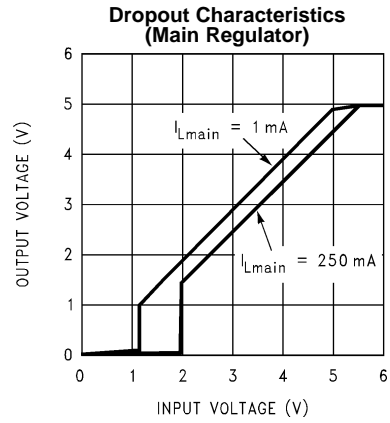

Figure 11.

Dropout Voltage vs Temperature (Main Regulator)

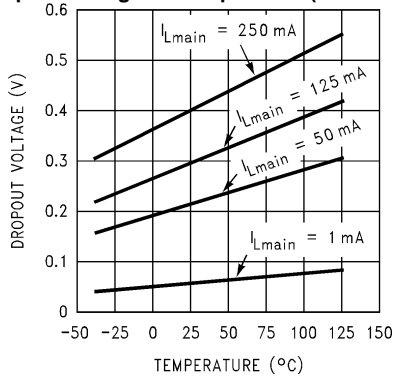

Figure 12.

Current Limit vs Regulator (Main Regulator)

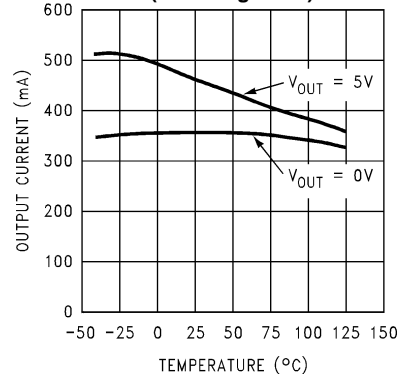

Figure 13.

Enable Transient (Main Regulator)

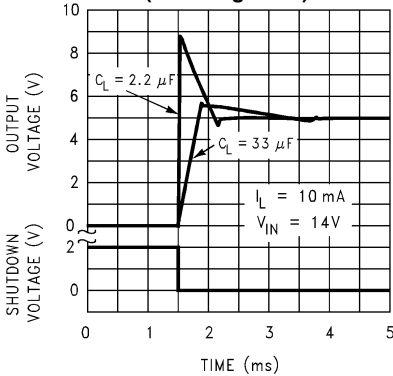

Figure 14.

Enable Transient (Main Regulator)

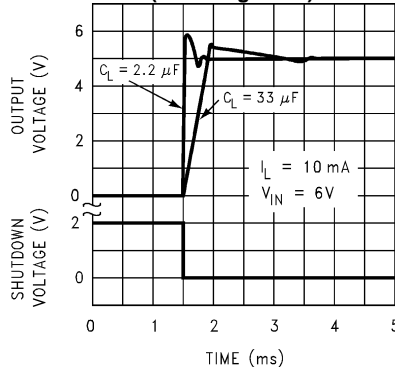

Figure 15.

Typical Performance Characteristics (continued)

Unless otherwise specified: $V_{IN} = 6V$, $C_L = 2.2 \mu F$ (Main Output) and $10 \mu F$ (Auxiliary Output), Feedback is tied to 5V Tap pin, $C_{IN} = 1 \mu F$, $V_{SD} = 0V$, Main Output pin is tied to Output Sense pin, Auxiliary Output is programmed for 5V. The main regulator output has a 1 mA load, the auxiliary output has a $100 \mu A$ load.

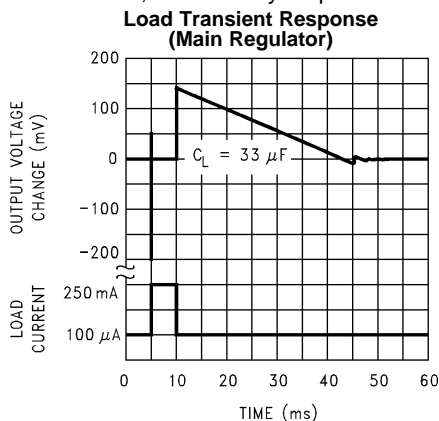

Figure 16.

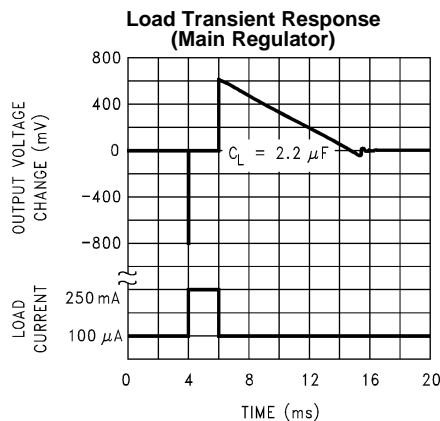

Figure 17.

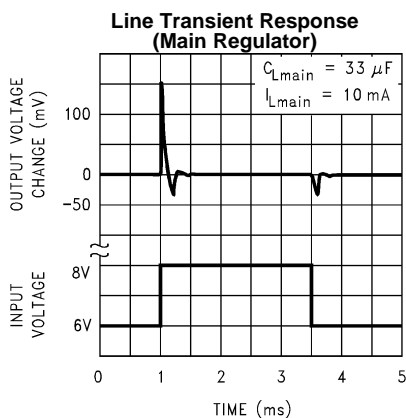

Figure 18.

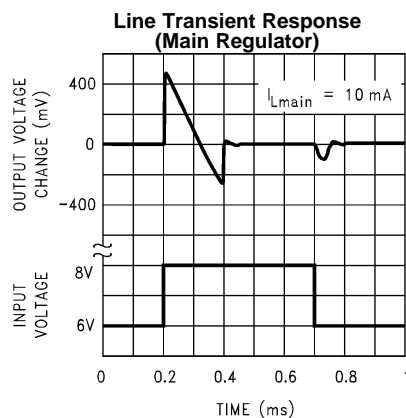

Figure 19.

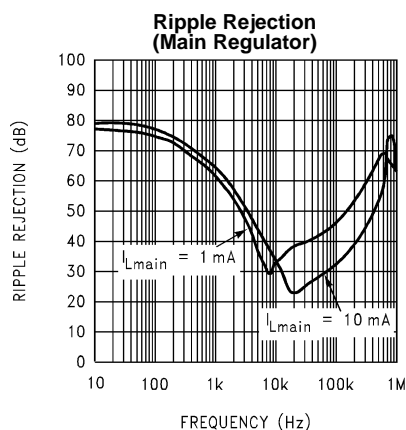

Figure 20.

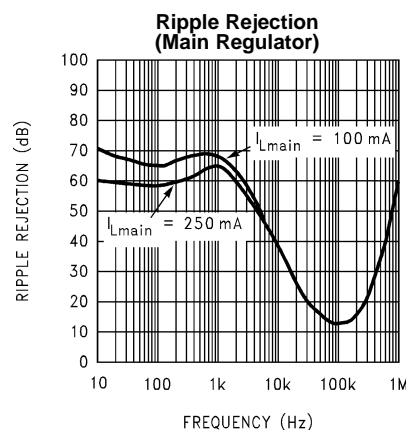

Figure 21.

LP2956, LP2956A

SNVS101E –MAY 1999–REVISED APRIL 2013

www.ti.com

Typical Performance Characteristics (continued)

Unless otherwise specified: $V_{IN} = 6V$, $C_L = 2.2 \mu F$ (Main Output) and $10 \mu F$ (Auxiliary Output), Feedback is tied to 5V Tap pin, $C_{IN} = 1 \mu F$, $V_{SD} = 0V$, Main Output pin is tied to Output Sense pin, Auxiliary Output is programmed for 5V. The main regulator output has a 1 mA load, the auxiliary output has a $100 \mu A$ load.

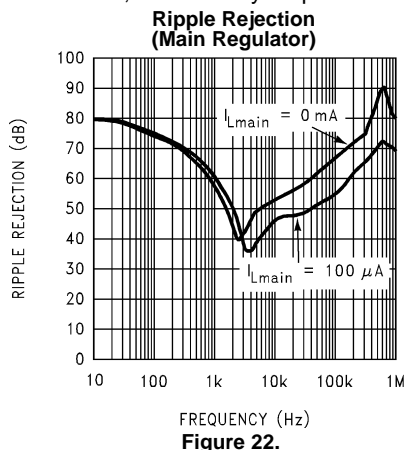

Figure 22.

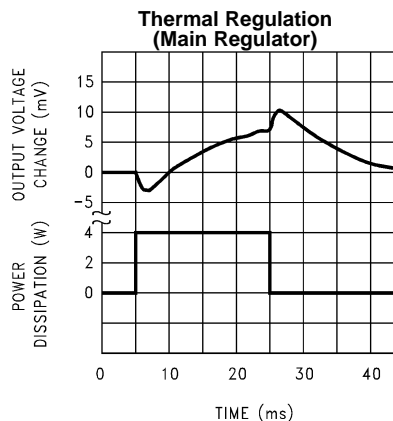

Figure 23.

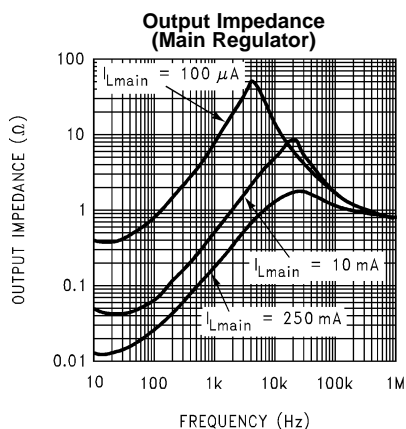

Figure 24.

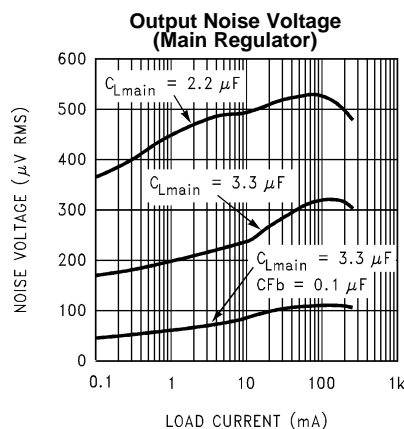

Figure 25.

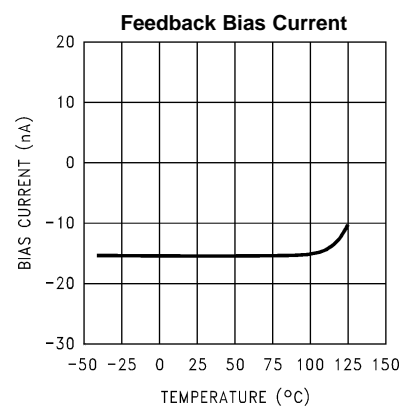

Figure 26.

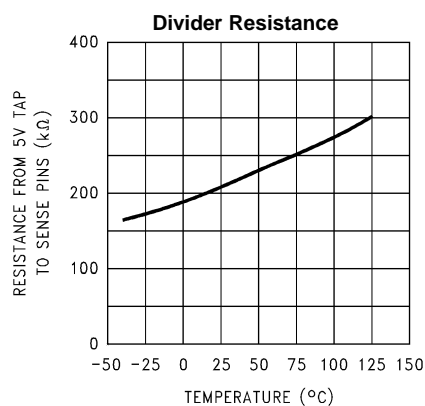

Figure 27.

Typical Performance Characteristics (continued)

Unless otherwise specified: $V_{IN} = 6V$, $C_L = 2.2 \mu F$ (Main Output) and $10 \mu F$ (Auxiliary Output), Feedback is tied to 5V Tap pin, $C_{IN} = 1 \mu F$, $V_{SD} = 0V$, Main Output pin is tied to Output Sense pin, Auxiliary Output is programmed for 5V. The main regulator output has a 1 mA load, the auxiliary output has a 100 μA load.

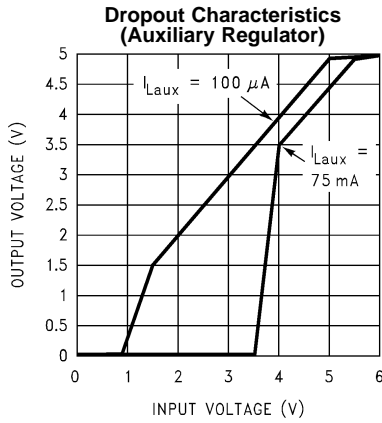

Figure 28.

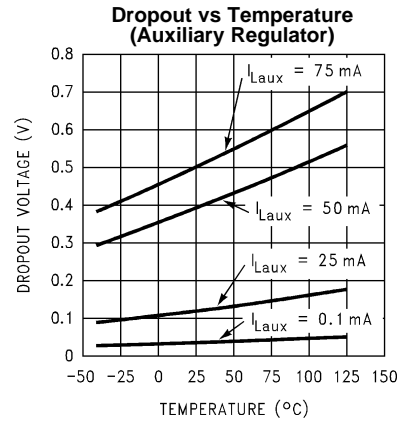

Figure 29.

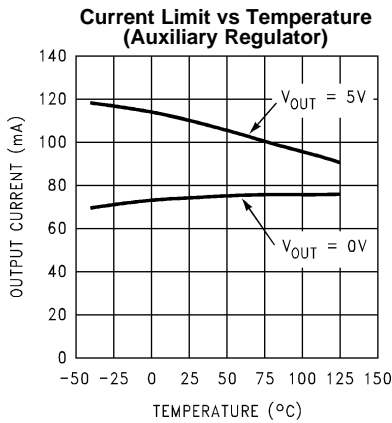

Figure 30.

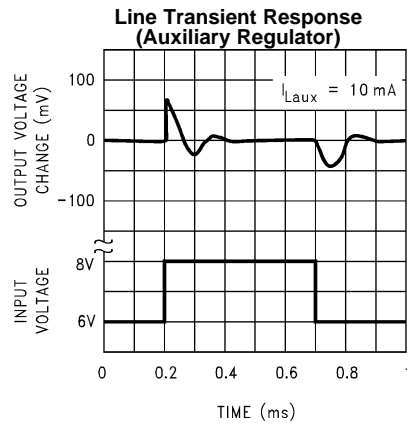

Figure 31.

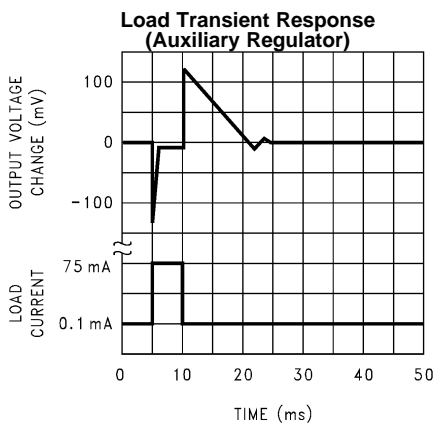

Figure 32.

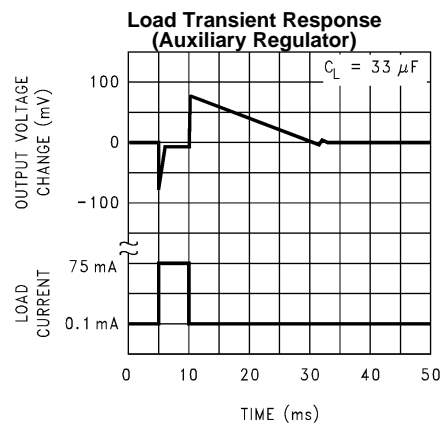

Figure 33.

LP2956, LP2956A

SNVS101E –MAY 1999–REVISED APRIL 2013

www.ti.com

Typical Performance Characteristics (continued)

Unless otherwise specified: $V_{IN} = 6V$, $C_L = 2.2 \mu F$ (Main Output) and $10 \mu F$ (Auxiliary Output), Feedback is tied to 5V Tap pin, $C_{IN} = 1 \mu F$, $V_{SD} = 0V$, Main Output pin is tied to Output Sense pin, Auxiliary Output is programmed for 5V. The main regulator output has a 1 mA load, the auxiliary output has a 100 μA load.

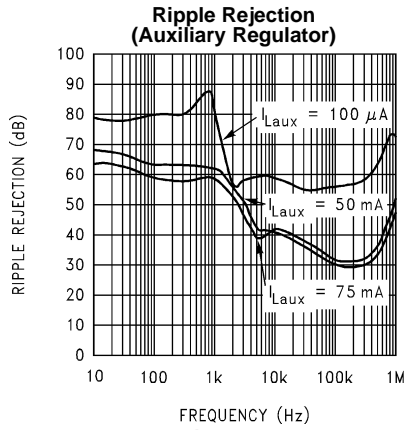

Figure 34.

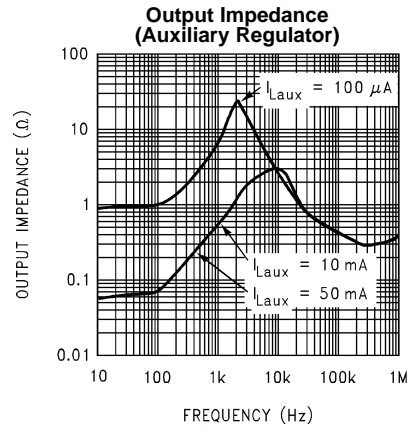

Figure 35.

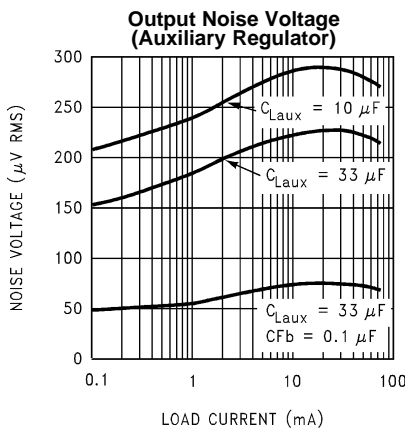

Figure 36.

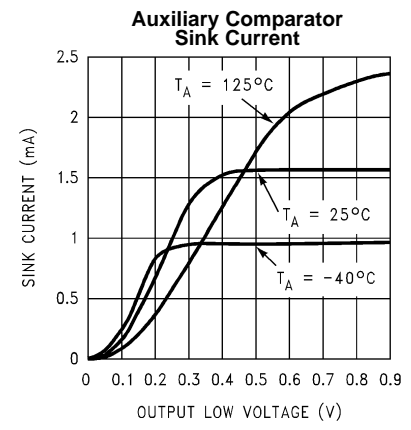

Figure 37.

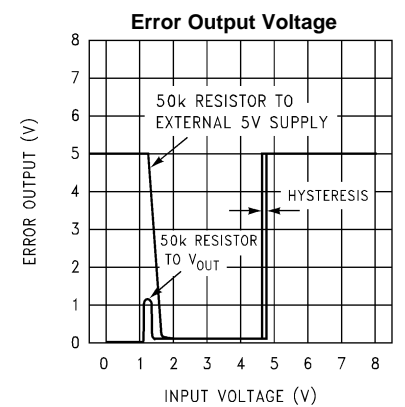

Figure 38.

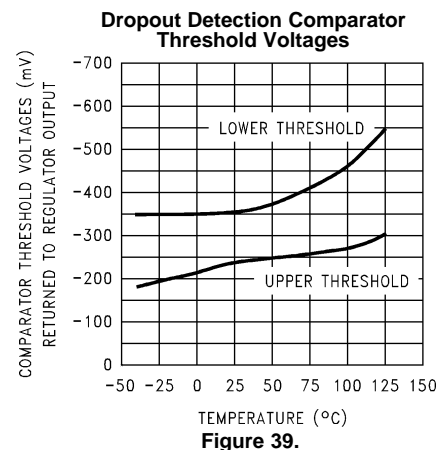

Figure 39.

APPLICATION HINTS

HEATSINK REQUIREMENTS

A heatsink may be required with the LP2956 depending on the maximum power dissipation and maximum ambient temperature of the application. Under all expected operating conditions, the junction temperature must be within the range specified under Absolute Maximum Ratings.

To determine if a heatsink is required, the maximum power dissipated by the regulator, P(max), must be calculated. It is important to remember that if the regulator is powered from a transformer connected to the AC line, the **maximum specified AC input voltage** must be used (since this produces the maximum DC input voltage to the regulator). Figure 40 shows the voltages and currents which are present in the circuit. The formula for calculating the power dissipated in the regulator is also shown in Figure 40 (the currents and power due to external resistive dividers are not included, and are typically negligible).

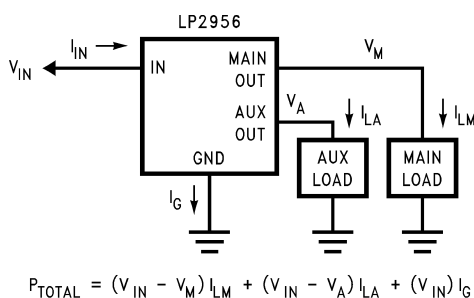

Figure 40. Current/Voltage Diagram

The next parameter which must be calculated is the maximum allowable temperature rise, $T_R(max)$. This is calculated by using the formula:

$$T_R(max) = T_J(max) - T_A(max) \tag{1}$$

where: $T_J(max)$ is the maximum allowable junction temperature

$T_A(max)$ is the maximum ambient temperature

Using the calculated values for $T_R(max)$ and P(max), the required value for junction-to-ambient thermal resistance, $\theta_{(J-A)}$, can now be found:

$$\theta_{(J-A)} = T_R(max)/P(max) \tag{2}$$

The heatsink for the LP2956 is made using the PC board copper. The heat is conducted from the die, through the lead frame (inside the part), and out the pins which are soldered to the PC board. The pins used for heat conduction are shown in Table 1.

Table 1.

Part	Package	Pins
LP2956IN	16-Pin Plastic DIP	4, 5, 12, 13
LP2956AIN	16-Pin Plastic DIP	4, 5, 12, 13
LP2956IM	16-Pin Surface Mt.	1, 8, 9, 16
LP2956AIM	16-Pin Surface Mt.	1, 8, 9, 16

LP2956, LP2956A

SNVS101E –MAY 1999–REVISED APRIL 2013

www.ti.com

Figure 41 shows copper patterns which may be used to dissipate heat from the LP2956:

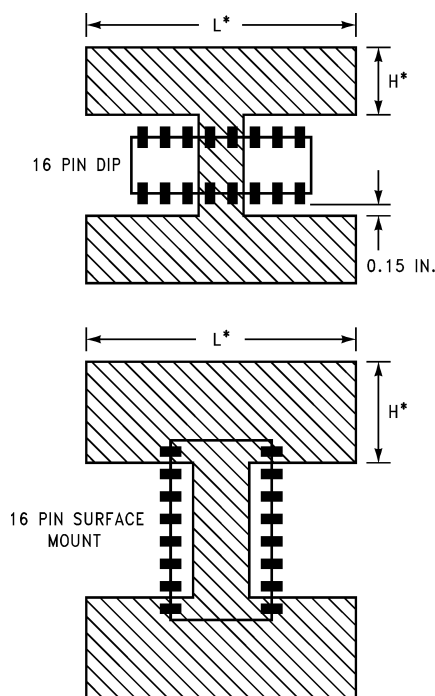

*For best results, use $L = 2H$

Figure 41. Copper Heatsink Patterns

Table 2 shows some typical values of junction-to-ambient thermal resistance (θ_{J-A}) for values of L and W (1 oz. copper).

Table 2.

Package	L (In.)	H (In.)	θ_{J-A} ($^{\circ}\text{C}/\text{W}$)
16-Pin Plastic DIP	1	0.5	70
	2	1	60
	3	1.5	58
	4	0.19	66
	6	0.19	66
16-Pin Surface Mount	1	0.5	83
	2	1	70
	3	1.5	67
	6	0.19	69
	4	0.19	71
	2	0.19	73

EXTERNAL CAPACITORS

A 2.2 μF (or greater) capacitor is required between the main output pin and ground to assure stability. The auxiliary output requires 10 μF to ground. Without these capacitors, the part may oscillate. Most types of tantalum or aluminum electrolytics will work here. Film types will work, but are more expensive. Many aluminum electrolytics contain electrolytes which freeze at -30°C , which requires the use of solid tantalums below -25°C . The important characteristic of the capacitors is an ESR of 5 Ω (or less) on the main regulator output and an ESR of 1 Ω (or less) on the auxiliary regulator output (the ESR may increase by a factor of **20** or **30** as the temperature is reduced from $+25^{\circ}\text{C}$ to -30°C). The value of these capacitors may be increased without limit.

The main output requires less capacitance at lighter load currents. This capacitor can be reduced to 0.68 μF for currents below 10 mA or 0.22 μF for currents below 1 mA.

Programming the main output for voltages below 5V requires *more* output capacitance for stability. For the worst-case condition of 1.23V output and 250 mA of load current, a 6.8 μF (or larger) capacitor should be used.

A 1 μF capacitor should be placed from the input pin to ground if there is more than 10 inches of wire between the input and the AC filter capacitor or if a battery input is used.

Stray capacitance to the Feedback terminal can cause instability. This problem is most likely to appear when using high value external resistors to set the output voltage. Adding a 100 pF capacitor between the Output and Feedback pins and increasing the output capacitance to 6.8 μF (or greater) will cure the problem.

MINIMUM LOAD ON MAIN OUTPUT

When setting the main output voltage using an external resistive divider, a minimum current of 10 μA is recommended through the resistors to provide a minimum load.

It should be noted that a minimum load current is specified in several of the electrical characteristic test conditions, so the specified value must be used to obtain test limit correlation.

PROGRAMMING THE MAIN OUTPUT VOLTAGE

The main output may be pin-strapped for 5V operation using its internal resistive divider by tying the Output and Sense pins together and also tying the Feedback and 5V Tap pins together.

Alternatively, it may be programmed for any voltage between the 1.23V reference and the 29V maximum rating using an external pair of resistors (see Figure 42). The complete equation for the output voltage is:

$$V_{\text{MAIN OUT}} = V_{\text{REF}} \times \left(1 + \frac{R1}{R2} \right) + (I_{\text{FB}} \times R1) \tag{3}$$

where V_{REF} is the 1.23V reference and I_{FB} is the Feedback pin bias current (–20 nA typical). The minimum recommended load current of 1 μA sets an upper limit of 1.2 M Ω on the value of R2 in cases where the regulator must work with no load (see MINIMUM LOAD ON MAIN OUTPUT).

If I_{FB} is ignored in the calculation of the output voltage, it will produce a small error in $V_{\text{MAIN OUT}}$. Choosing R2 = 100 k Ω will reduce this error to 0.16% (typical) while increasing the resistor program current to 12 μA . Since the typical quiescent current is 130 μA , this added current is negligible.

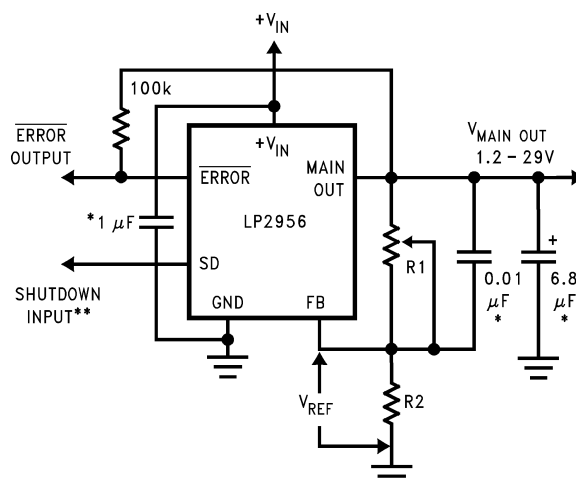

*See Application Hints

**Drive with high to shut down

Figure 42. Adjustable Regulator

LP2956, LP2956A

SNVS101E –MAY 1999–REVISED APRIL 2013

www.ti.com

DROPOUT VOLTAGE

The dropout voltage of the regulator is defined as the minimum input-to-output voltage differential required for the output voltage to stay within 100 mV of the output voltage measured with a 1V differential. The dropout voltage is independent of the programmed output voltage.

DROPOUT DETECTION COMPARATOR

This comparator produces a logic “LOW” whenever the main output falls out of regulation by more than about 5%. This figure results from the comparator's built-in offset of 60 mV divided by the 1.23V reference (refer to block diagram). The 5% low trip level remains constant regardless of the programmed output voltage. An out-of-regulation condition can result from low input voltage, current limiting, or thermal limiting.

Figure 43 gives a timing diagram showing the relationship between the main output voltage, the $\overline{\text{ERROR}}$ output, and input voltage as the input voltage is ramped up and down to a regulator whose main output is programmed for 5V. The $\overline{\text{ERROR}}$ signal becomes low at about 1.3V input. It goes high at about 5V input, where the main output equals 4.75V. Since the dropout voltage is load dependent, the **input** voltage trip points will vary with load current. The **main output** voltage trip point does not vary.

The comparator has an open-collector output which requires an external pull-up resistor. This resistor may be connected to the regulator main output or some other supply voltage. Using the main output prevents an invalid “HIGH” on the comparator output which occurs if it is pulled up to an external voltage while the regulator input voltage is reduced below 1.3V. In selecting a value for the pull-up resistor, note that while the output can sink 400 μA , this current adds to battery drain. Suggested values range from 100 k Ω to 1 M Ω . The resistor is not required if the output is unused.

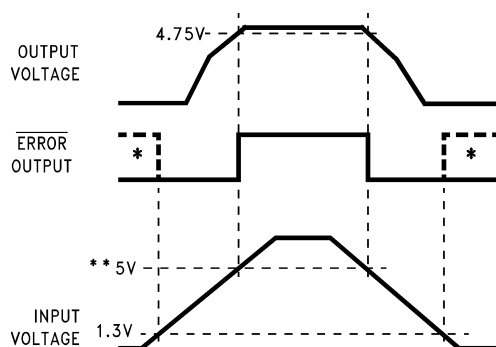

*In shutdown mode, $\overline{\text{ERROR}}$ will go high if it has been pulled up to an external supply. To avoid this invalid response, pull up to regulator output

**Exact value depends on dropout voltage. (See Application Hints)

Figure 43. $\overline{\text{ERROR}}$ Output Timing

If a single pull-up resistor is used to the regulator output, the error flag may briefly rise up to about 1.3V as the input voltage ramps up or down through the 0V to 1.3V region.

In some cases, this 1.3V signal may be mis-interpreted as a false high by a μP which is still “alive” with 1.3V applied to it.

To prevent this, the user may elect to use **two** resistors which are equal in value on the error output (one connected to ground and the other connected to the regulator output).

If this two-resistor divider is used, the error output will only be pulled up to about 0.6V (not 1.3V) during power-up or power-down, so it can not be interpreted as a high signal. When the regulator output is at 5V, the error output will be 2.5V, which is still clearly a high signal.

OUTPUT ISOLATION

The regulator outputs can be left connected to an active voltage source (such as a battery) with the regulator input power shut off, as long as the regulator ground pin is connected to ground. If the ground pin is left floating, damage to the regulator can occur if the output is pulled up by an external voltage source.

REDUCING MAIN OUTPUT NOISE

In reference applications it may be advantageous to reduce the AC noise present on the main output. One method is to reduce regulator bandwidth by increasing output capacitance. This is relatively inefficient, since large increases in capacitance are required to get significant improvement.

Noise can be reduced more effectively by a bypass capacitor placed across R1 (refer to Figure 42). The formula for selecting the capacitor to be used is:

$$CB = \frac{1}{2\pi R1 \times 20 \text{ Hz}} \tag{4}$$

This gives a value of about 0.1µF. When this is used, the output capacitor must be 6.8 µF (or greater) to maintain stability. The 0.1 µF capacitor reduces the high frequency noise gain of the circuit to unity, lowering the output noise from 260 µV to 80 µV using a 10 Hz to 100 kHz bandwidth. Also, noise is no longer proportional to the output voltage, so improvements are more pronounced at higher output voltages.

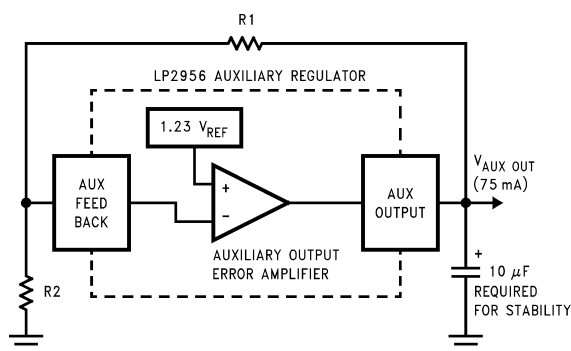

$$V_{AUX\ OUT} = V_{REF} \left(1 + \frac{R1}{R2} \right) + (I_{FB} \times R1)$$

where: $V_{REF} = 1.23V$ and $I_{FB} = -10 \text{ nA}$ (typical)

Figure 44. Auxiliary Adjustable Regulator

AUXILIARY LDO OUTPUT

The LP2956 has an auxiliary LDO regulator output (which can source up to 75 mA) that is adjustable for voltages from 1.23V to 29V.

The output voltage is set by an external resistive divider, as shown in Figure 44. The maximum output current is 75 mA, and the output requires 10 µF from the output to ground for stability, regardless of load current.

SHUTDOWN INPUT

The shutdown input equivalent circuit is shown in Figure 45. The main regulator output is shut down when the NPN transistor is turned ON.

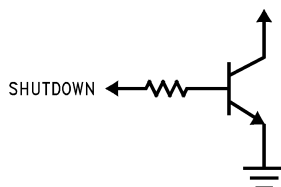

Figure 45. Shutdown Circuitry

The current into the input should be at least 0.5 µA to assure the output shutdown function. A resistor may be placed in series with the input to minimize current draw in shutdown mode, provided this minimum input current requirement is met.

LP2956, LP2956A

SNVS101E –MAY 1999–REVISED APRIL 2013

www.ti.com

IMPORTANT:

The shutdown input must not be left floating: a pull-down resistor (10 kΩ to 50 kΩ recommended) must be connected between the shutdown input and ground in cases where the input is not actively pulled low.

SCHEMATIC DIAGRAM

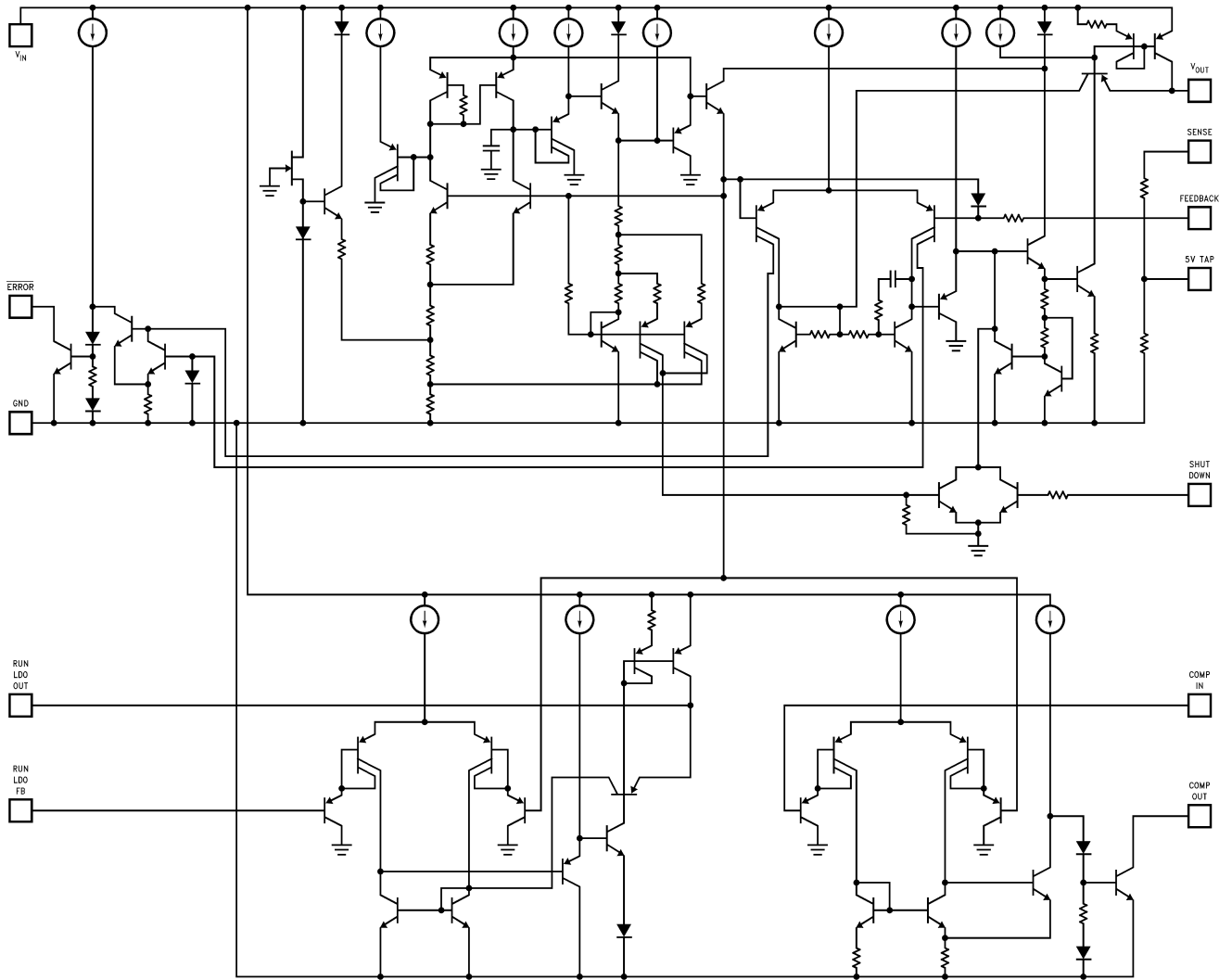

TYPICAL APPLICATIONS

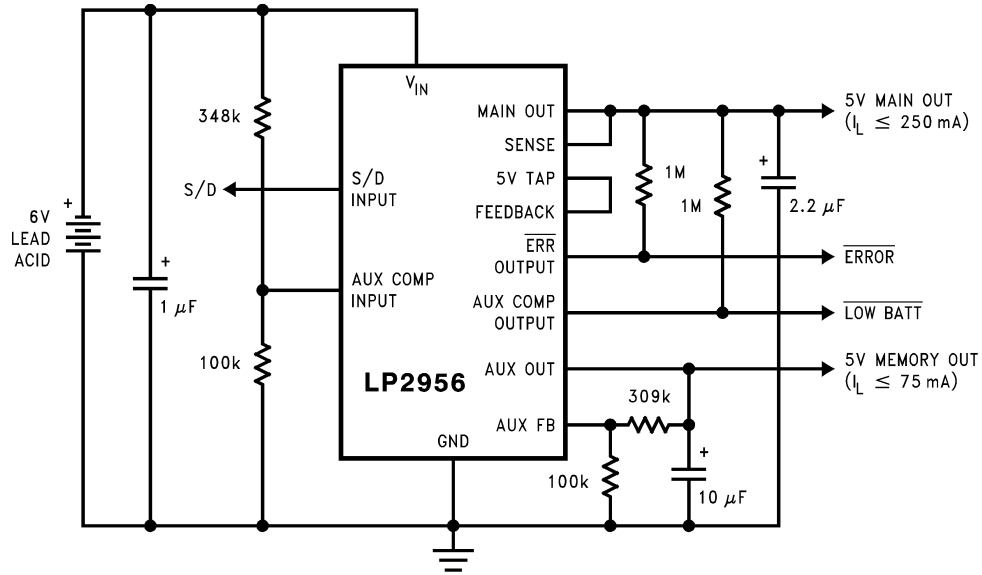

LP2956, LP2956A



SNVS101E –MAY 1999–REVISED APRIL 2013

www.ti.com

REVISION HISTORY

Changes from Revision D (April 2013) to Revision E **Page**

- Changed layout of National Data Sheet to TI format [19](#)

IMPORTANT NOTICE

Texas Instruments Incorporated and its subsidiaries (TI) reserve the right to make corrections, enhancements, improvements and other changes to its semiconductor products and services per JESD46, latest issue, and to discontinue any product or service per JESD48, latest issue. Buyers should obtain the latest relevant information before placing orders and should verify that such information is current and complete. All semiconductor products (also referred to herein as "components") are sold subject to TI's terms and conditions of sale supplied at the time of order acknowledgment.

TI warrants performance of its components to the specifications applicable at the time of sale, in accordance with the warranty in TI's terms and conditions of sale of semiconductor products. Testing and other quality control techniques are used to the extent TI deems necessary to support this warranty. Except where mandated by applicable law, testing of all parameters of each component is not necessarily performed.

TI assumes no liability for applications assistance or the design of Buyers' products. Buyers are responsible for their products and applications using TI components. To minimize the risks associated with Buyers' products and applications, Buyers should provide adequate design and operating safeguards.

TI does not warrant or represent that any license, either express or implied, is granted under any patent right, copyright, mask work right, or other intellectual property right relating to any combination, machine, or process in which TI components or services are used. Information published by TI regarding third-party products or services does not constitute a license to use such products or services or a warranty or endorsement thereof. Use of such information may require a license from a third party under the patents or other intellectual property of the third party, or a license from TI under the patents or other intellectual property of TI.

Reproduction of significant portions of TI information in TI data books or data sheets is permissible only if reproduction is without alteration and is accompanied by all associated warranties, conditions, limitations, and notices. TI is not responsible or liable for such altered documentation. Information of third parties may be subject to additional restrictions.

Resale of TI components or services with statements different from or beyond the parameters stated by TI for that component or service voids all express and any implied warranties for the associated TI component or service and is an unfair and deceptive business practice. TI is not responsible or liable for any such statements.

Buyer acknowledges and agrees that it is solely responsible for compliance with all legal, regulatory and safety-related requirements concerning its products, and any use of TI components in its applications, notwithstanding any applications-related information or support that may be provided by TI. Buyer represents and agrees that it has all the necessary expertise to create and implement safeguards which anticipate dangerous consequences of failures, monitor failures and their consequences, lessen the likelihood of failures that might cause harm and take appropriate remedial actions. Buyer will fully indemnify TI and its representatives against any damages arising out of the use of any TI components in safety-critical applications.

In some cases, TI components may be promoted specifically to facilitate safety-related applications. With such components, TI's goal is to help enable customers to design and create their own end-product solutions that meet applicable functional safety standards and requirements. Nonetheless, such components are subject to these terms.

No TI components are authorized for use in FDA Class III (or similar life-critical medical equipment) unless authorized officers of the parties have executed a special agreement specifically governing such use.

Only those TI components which TI has specifically designated as military grade or "enhanced plastic" are designed and intended for use in military/aerospace applications or environments. Buyer acknowledges and agrees that any military or aerospace use of TI components which have **not** been so designated is solely at the Buyer's risk, and that Buyer is solely responsible for compliance with all legal and regulatory requirements in connection with such use.

TI has specifically designated certain components as meeting ISO/TS16949 requirements, mainly for automotive use. In any case of use of non-designated products, TI will not be responsible for any failure to meet ISO/TS16949.

Products

Audio	www.ti.com/audio
Amplifiers	amplifier.ti.com
Data Converters	dataconverter.ti.com
DLP® Products	www.dlp.com
DSP	dsp.ti.com
Clocks and Timers	www.ti.com/clocks
Interface	interface.ti.com
Logic	logic.ti.com
Power Mgmt	power.ti.com
Microcontrollers	microcontroller.ti.com
RFID	www.ti-rfid.com
OMAP Applications Processors	www.ti.com/omap
Wireless Connectivity	www.ti.com/wirelessconnectivity

Applications

Automotive and Transportation	www.ti.com/automotive
Communications and Telecom	www.ti.com/communications
Computers and Peripherals	www.ti.com/computers
Consumer Electronics	www.ti.com/consumer-apps
Energy and Lighting	www.ti.com/energy
Industrial	www.ti.com/industrial
Medical	www.ti.com/medical
Security	www.ti.com/security
Space, Avionics and Defense	www.ti.com/space-avionics-defense
Video and Imaging	www.ti.com/video

TI E2E Community

e2e.ti.com