

Excellent Integrated System Limited

Stocking Distributor

Click to view price, real time Inventory, Delivery & Lifecycle Information:

[Sanken](#)
[2SA1186](#)

For any questions, you can email us directly:

sales@integrated-circuit.com

LAPT

2SA1186

Silicon PNP Epitaxial Planar Transistor (Complement to type 2SC2837)

Application : Audio and General Purpose

■Absolute maximum ratings (Ta=25°C)

Symbol	Ratings	Unit
V _{CB0}	-150	V
V _{CE0}	-150	V
V _{EBO}	-5	V
I _c	-10	A
I _B	-2	A
P _c	100(Ta=25°C)	W
T _J	150	°C
T _{stg}	-55 to +150	°C

■Electrical Characteristics (Ta=25°C)

Symbol	Conditions	Ratings	Unit
I _{cBO}	V _{CB} =-150V	-100max	μA
I _{EBO}	V _{EB} =-5V	-100max	μA
V(BR) _{CEO}	I _c =-25mA	-150min	V
h _{FE}	V _{CE} =-4V, I _c =-3A	50min*	
V _{CE(sat)}	I _c =-5A, I _B =-0.5A	-2.0max	V
f _r	V _{CE} =-12V, I _E =1A	60typ	MHz
COB	V _{CB} =-80V, f=1MHz	110typ	pF

*h_{FE} Rank \bar{O} (50 to 100), P(70 to 140), Y(90 to 180)

■Typical Switching Characteristics (Common Emitter)

V _{CC} (V)	R _L (Ω)	I _c (A)	V _{B2} (V)	I _{B1} (mA)	I _{B2} (mA)	t _{on} (μs)	t _{stg} (μs)	t _f (μs)
-60	12	-5	5	-500	500	0.25typ	0.8typ	0.2typ

External Dimensions MT-100(TO3P)

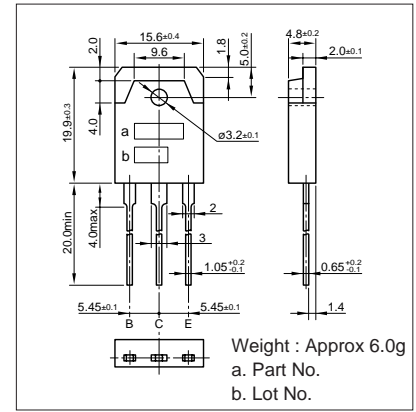

I_c-V_{CE} Characteristics (Typical)

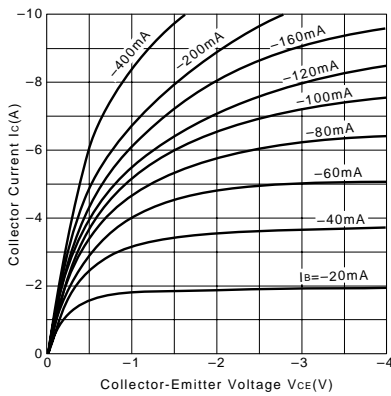

V_{CE(sat)}-I_B Characteristics (Typical)

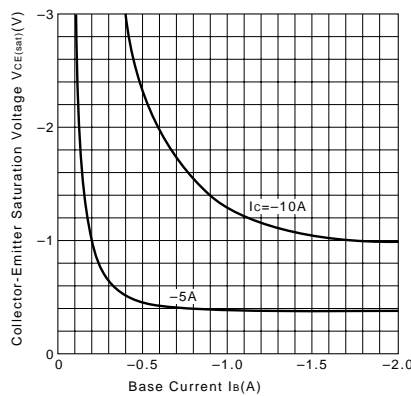

I_c-V_{BE} Temperature Characteristics (Typical)

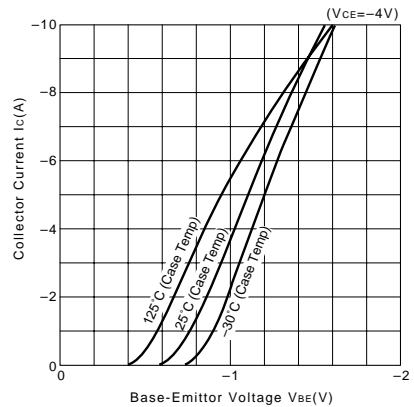

h_{FE}-I_c Characteristics (Typical)

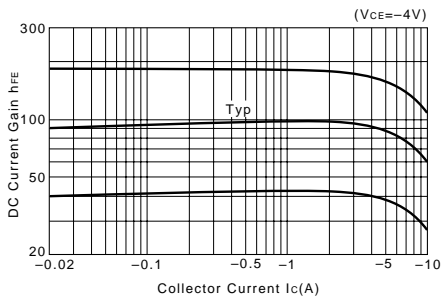

h_{FE}-I_c Temperature Characteristics (Typical)

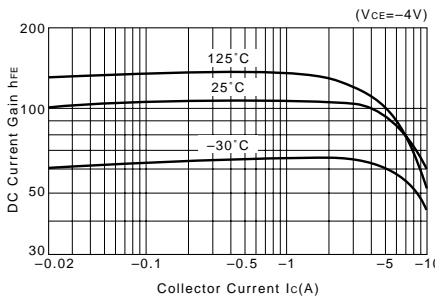

θ_{j-a}-t Characteristics

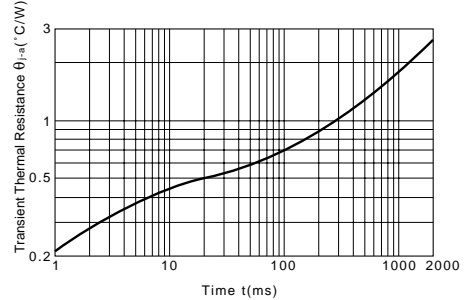

f_T-I_E Characteristics (Typical)

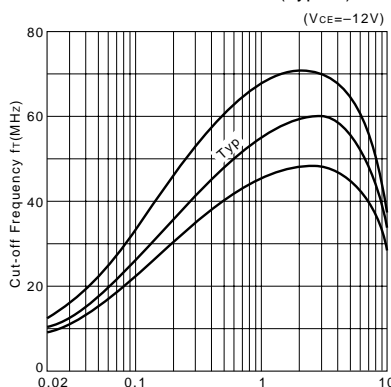

Safe Operating Area (Single Pulse)

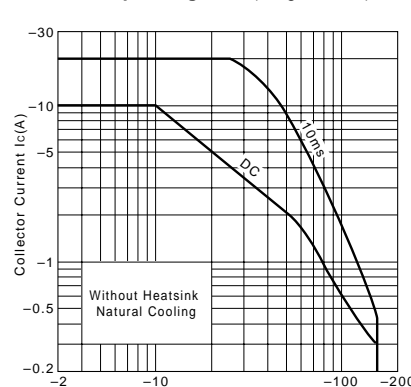

P_c-T_a Derating

