

Excellent Integrated System Limited

Stocking Distributor

Click to view price, real time Inventory, Delivery & Lifecycle Information:

[Taoglas Limited](#)
[FW.91.TNC.M](#)

For any questions, you can email us directly:
sales@integrated-circuit.com



SPECIFICATION

- Part No. : **FW.91.TNC.M**
- Product Name : Penta-band cellular 2G/3G
GSM/CDMA/UMTS
Flexible Whip Monopole Antenna
850/900/1800/1900/2100 MHz
- Feature : IP67
Robust Inner Steel Core
TNC Male Connector
RoHS Compliant✓





1. Specification

CELLULAR					
Frequency (MHz)	824~896	880~960	1710~1880	1850~1990	1710~2170
Peak Gain (dBi)					
Free Space	-0.7	-0.9	1.7	2.5	2.2
With Ground plane(30x30cm)	2.5	3.0	4.5	4.5	3.5
L - Bracket	3.0	3.0	3.5	4.5	2.5
Average Gain (dBi)					
Free Space	-5.7	-5.3	-2.3	-1.7	-3.9
With Ground plane(30x30cm)	-2.2	-2.6	-2.3	-1.7	-2.2
L - Bracket	-3.0	-2.6	-2.3	-1.7	-3.0
Efficiency					
Free Space	27%	30%	59%	68%	40%
With Ground plane(30x30cm)	60%	55%	59%	68%	60%
L - Bracket	50%	55%	59%	68%	50%
Impedance	50Ω				
Polarization	Linear				
Radiation Pattern	Omni				
Input Power	50 W				
MECHANICAL					
Dimensions	Height 255 ± 5 mm				
Base Diameter	16.05 ± 0.2 mm				
Whip Diameter	4 ± 0.2 mm				
Casing	ABS				
Connector	TNC Male				
ENVIRONMENTAL					
Temperature Range	-40°C to 85°C				
Humidity	Non-condensing 65°C 95% RH				



2. Antenna Characteristics

2.1. Return Loss

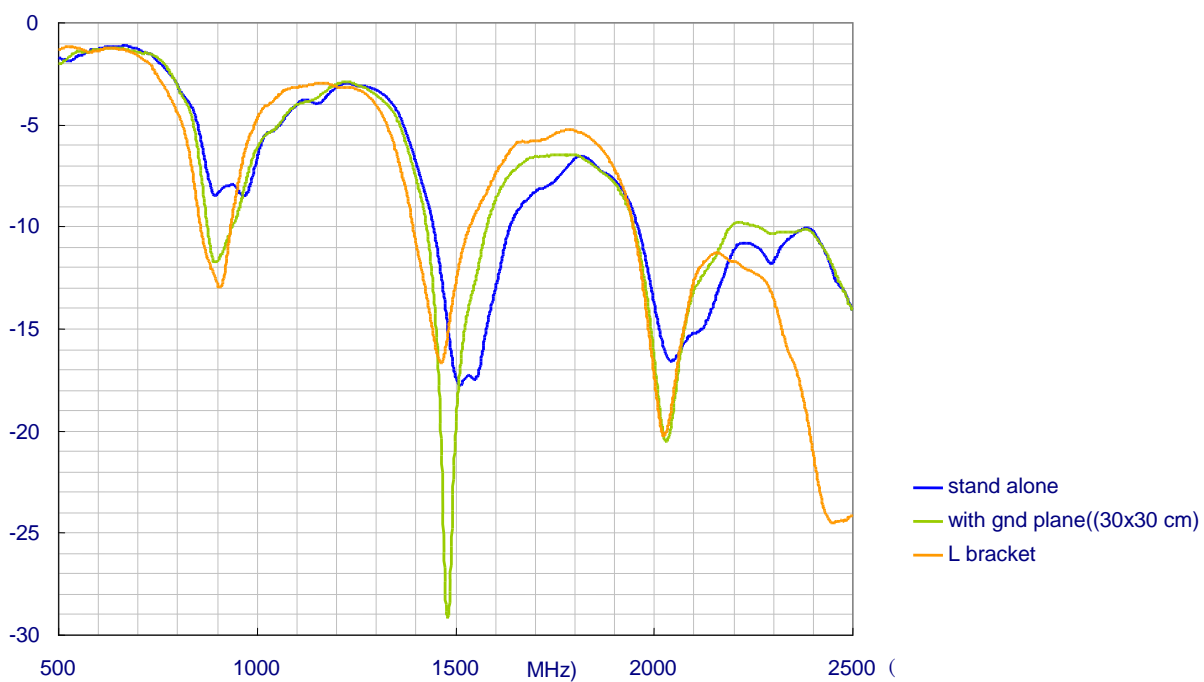



2.2. Antenna Efficiency

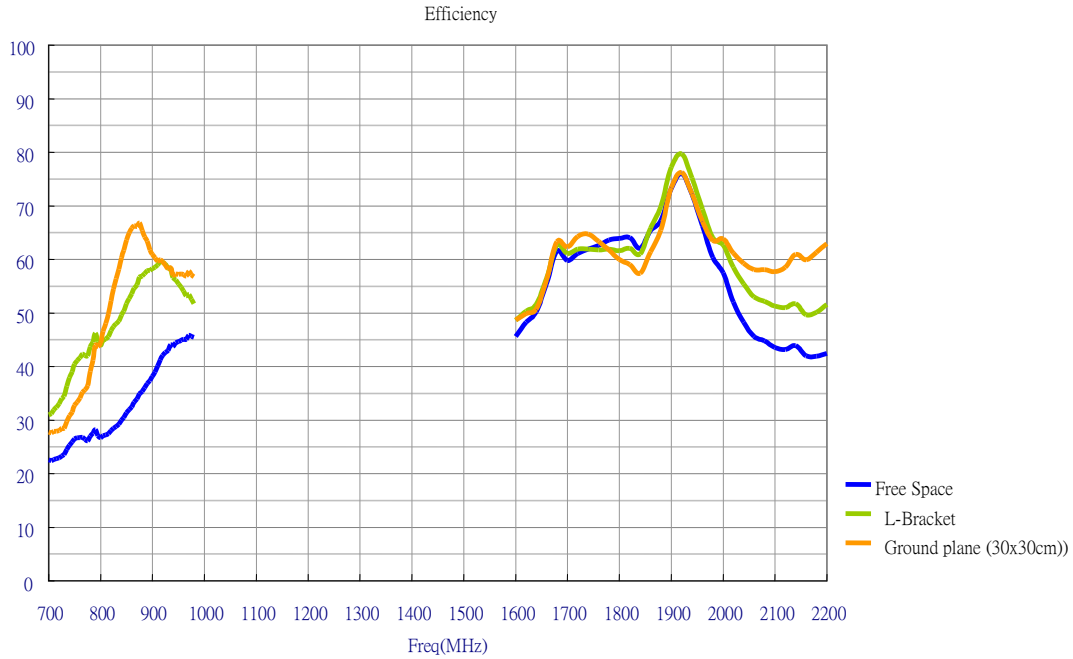

2.3. Peak Gain

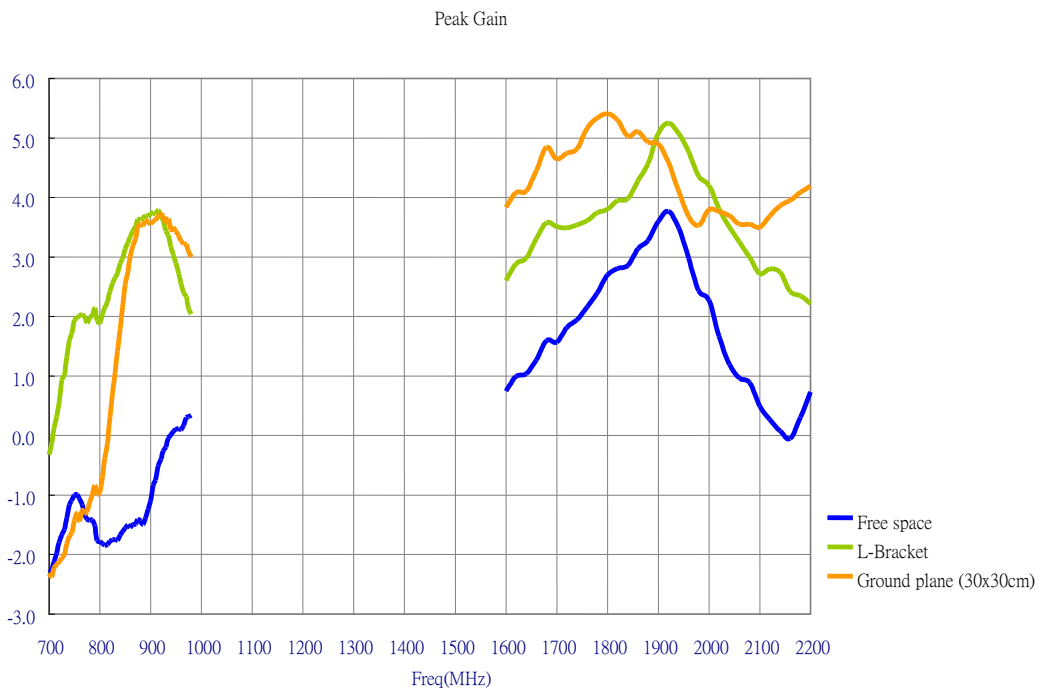

3. Antenna Radiation Pattern

3.1. Antenna Stand Alone

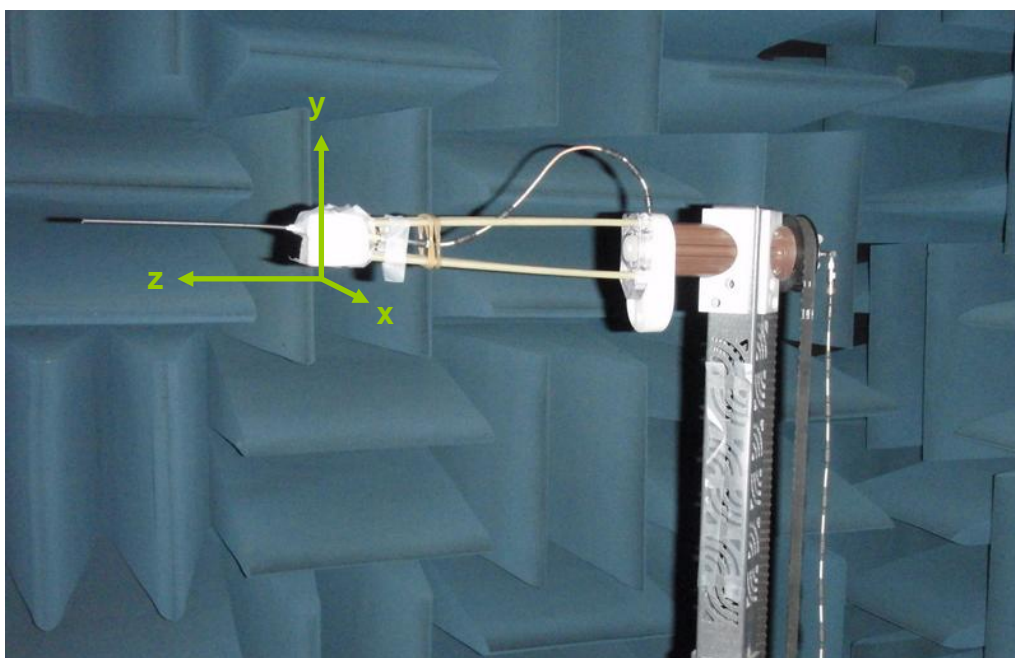



XY-plane

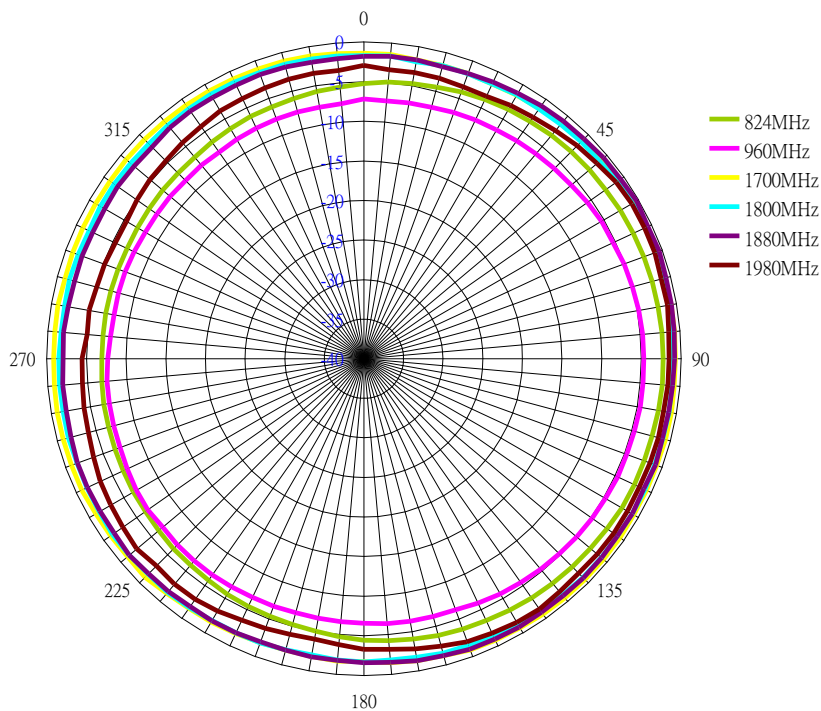

XZ-plane

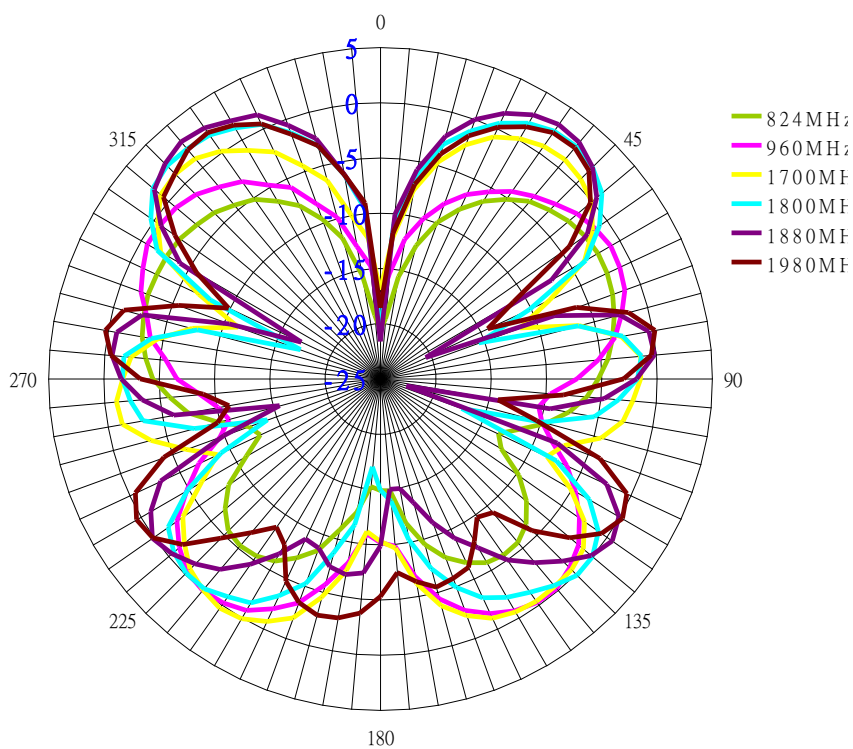

3.2. Antenna with Ground plane (30X30cm)

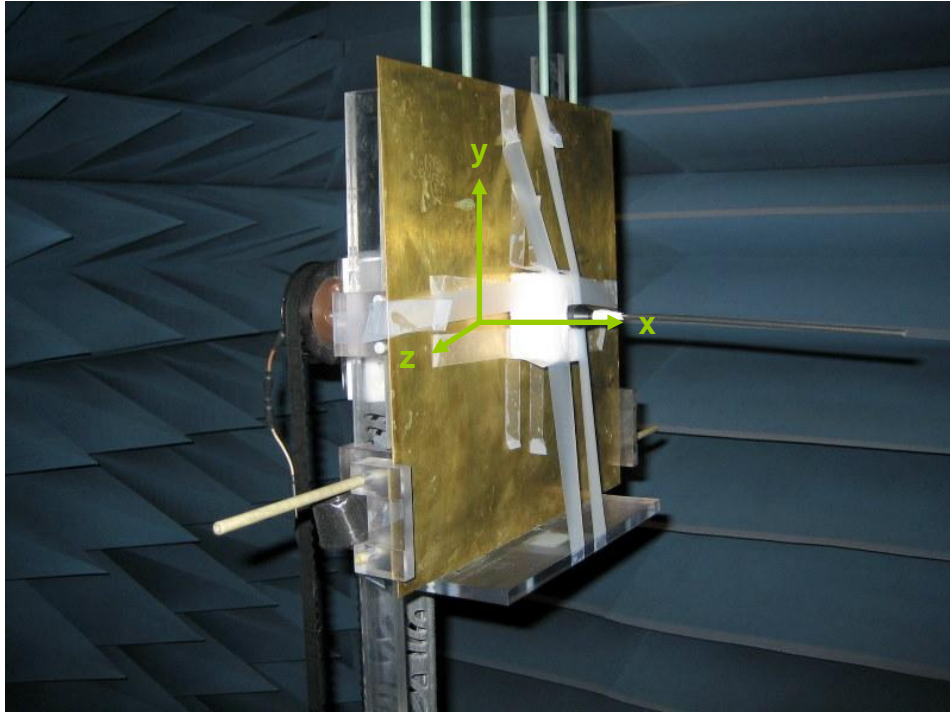



XY-plane

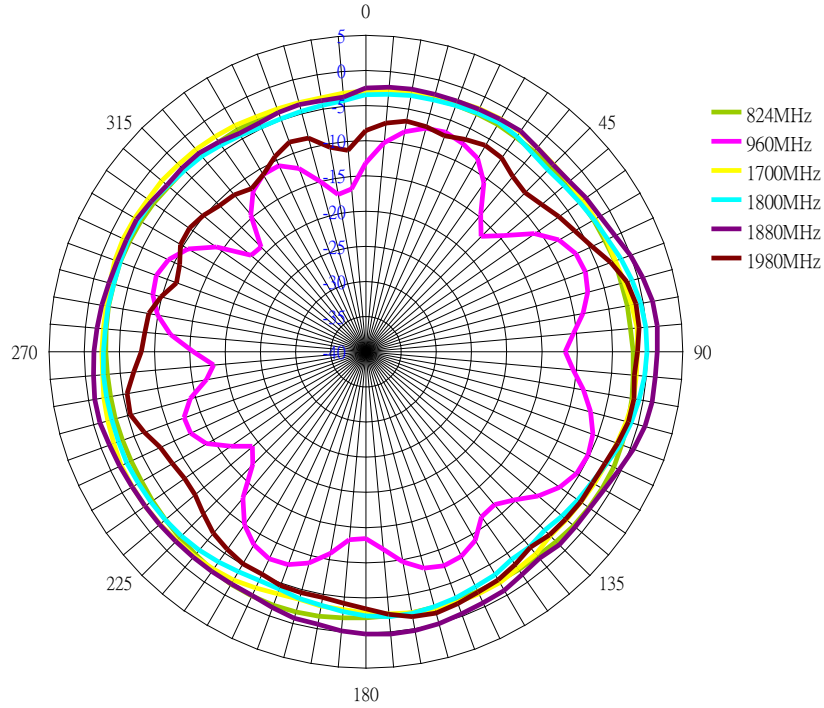

XZ-plane

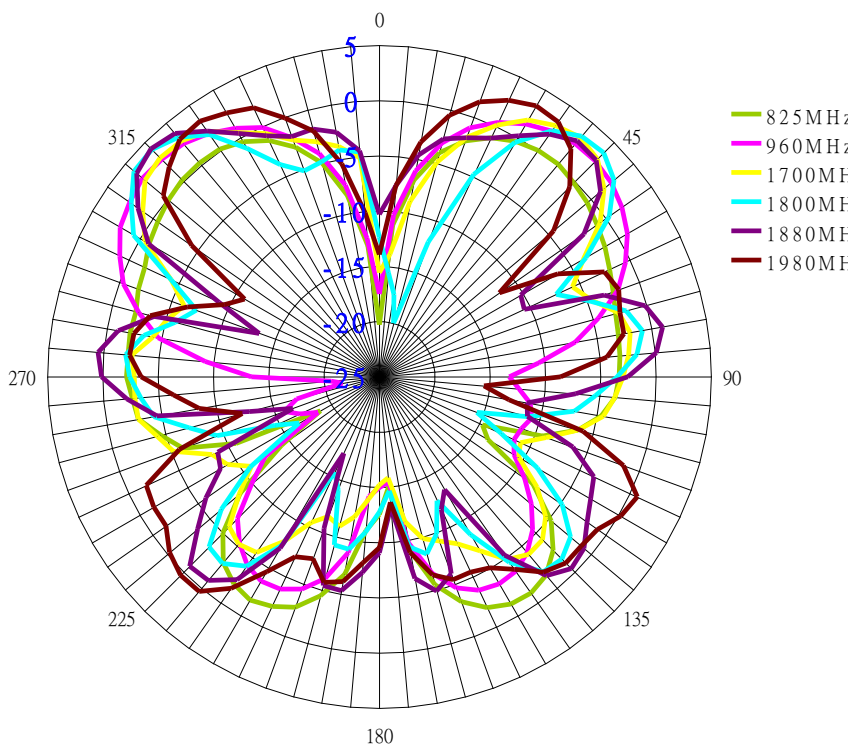

3.3. Antenna with L-Bracket

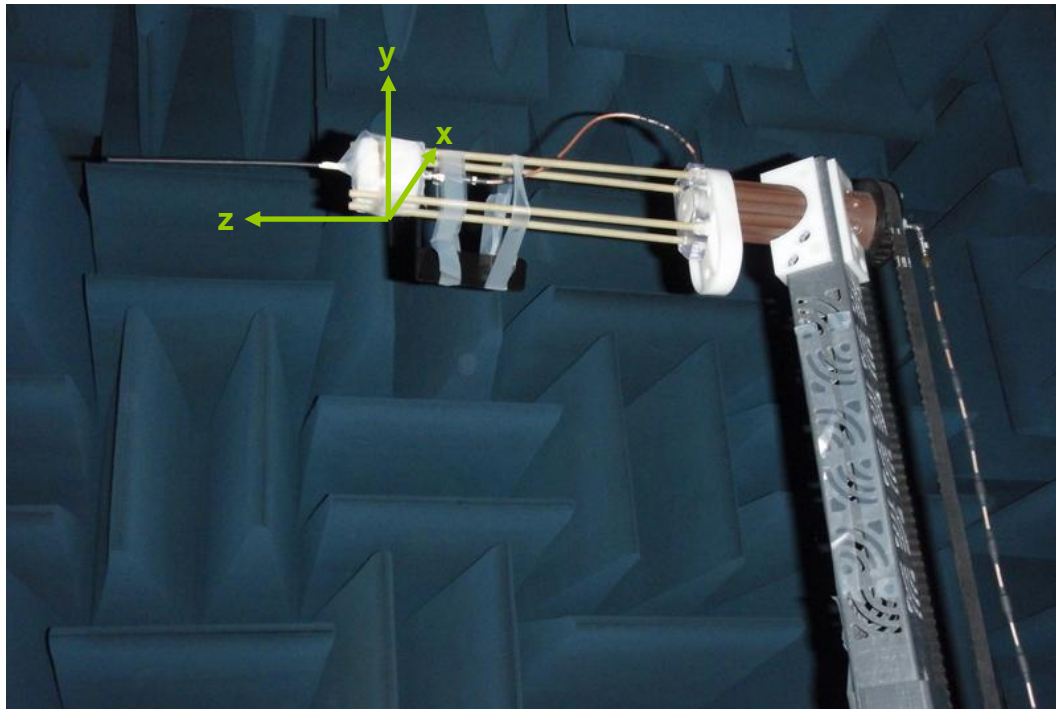



XY-plane

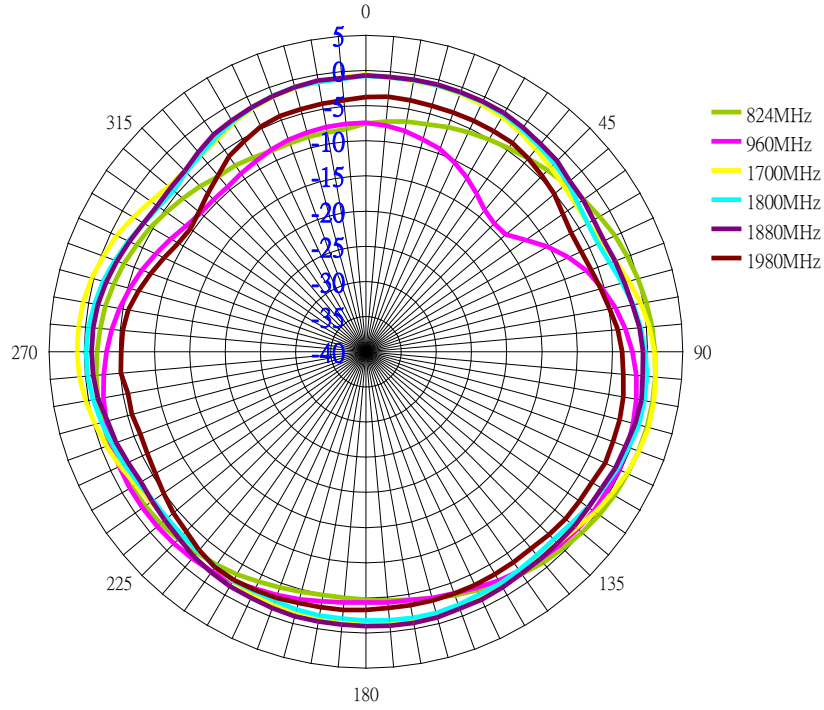

XZ-plane

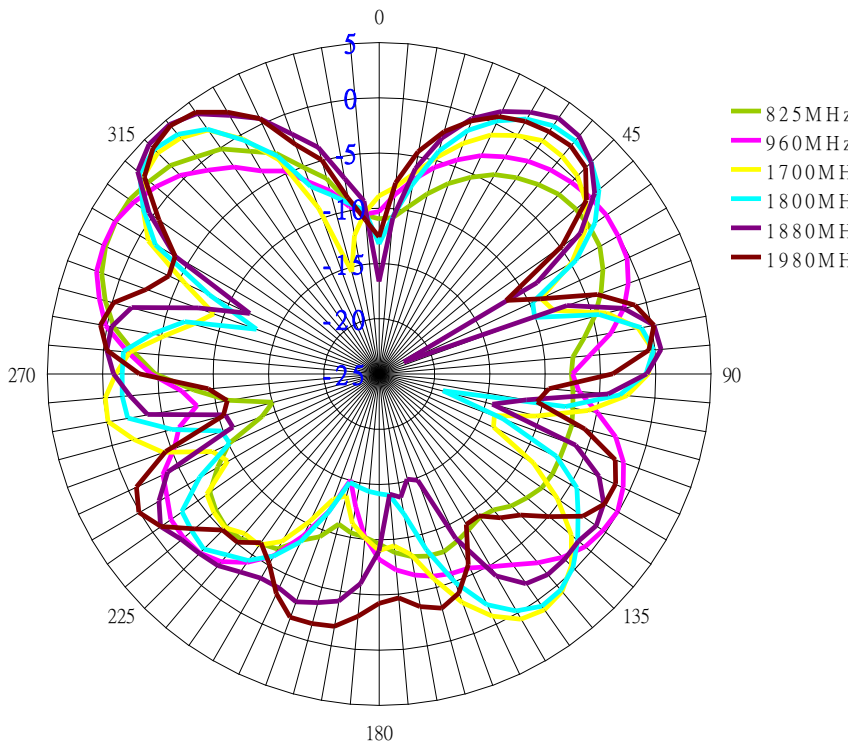



4. Antenna Drawing

Unit : mm

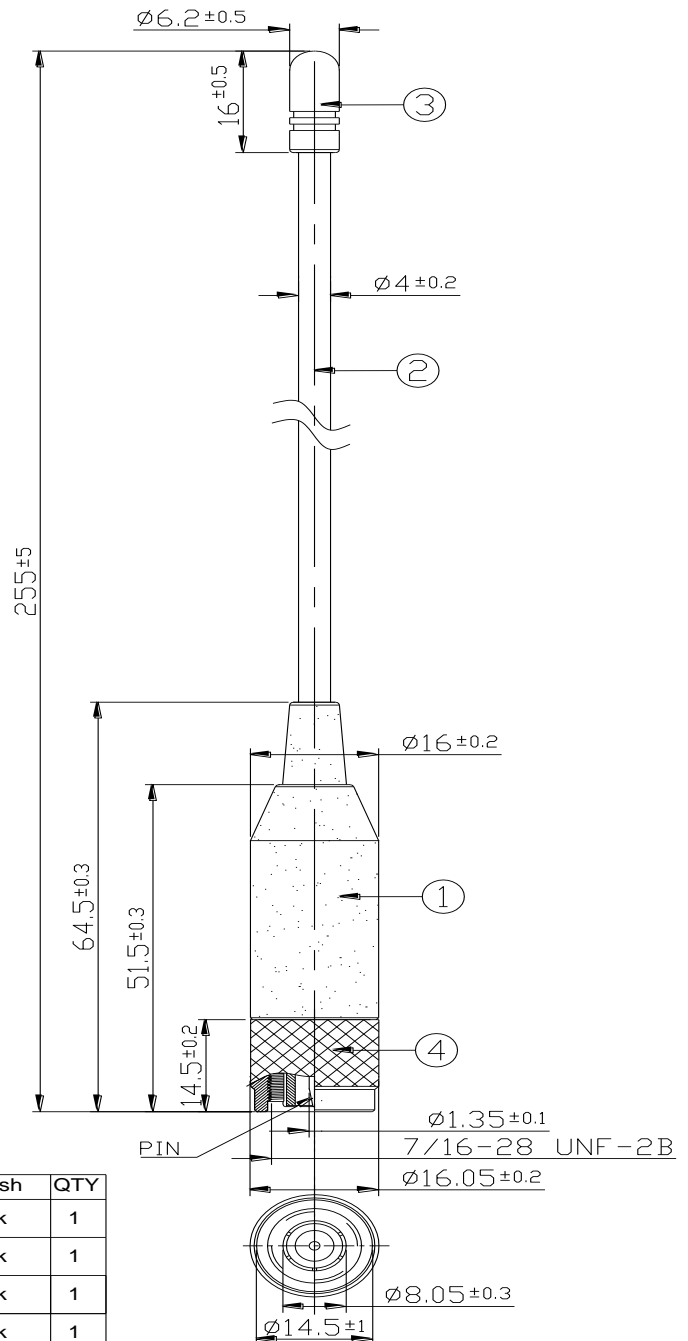

	Name	Material	Finish	QTY
1	Housing	ABS	Black	1
2	Internal Steel Cable	Steel+PE Jacket	Black	1
3	CAP	ABS	Black	1
4	Outer Body TNC (M)	Brass	Black	1

5. Packaging

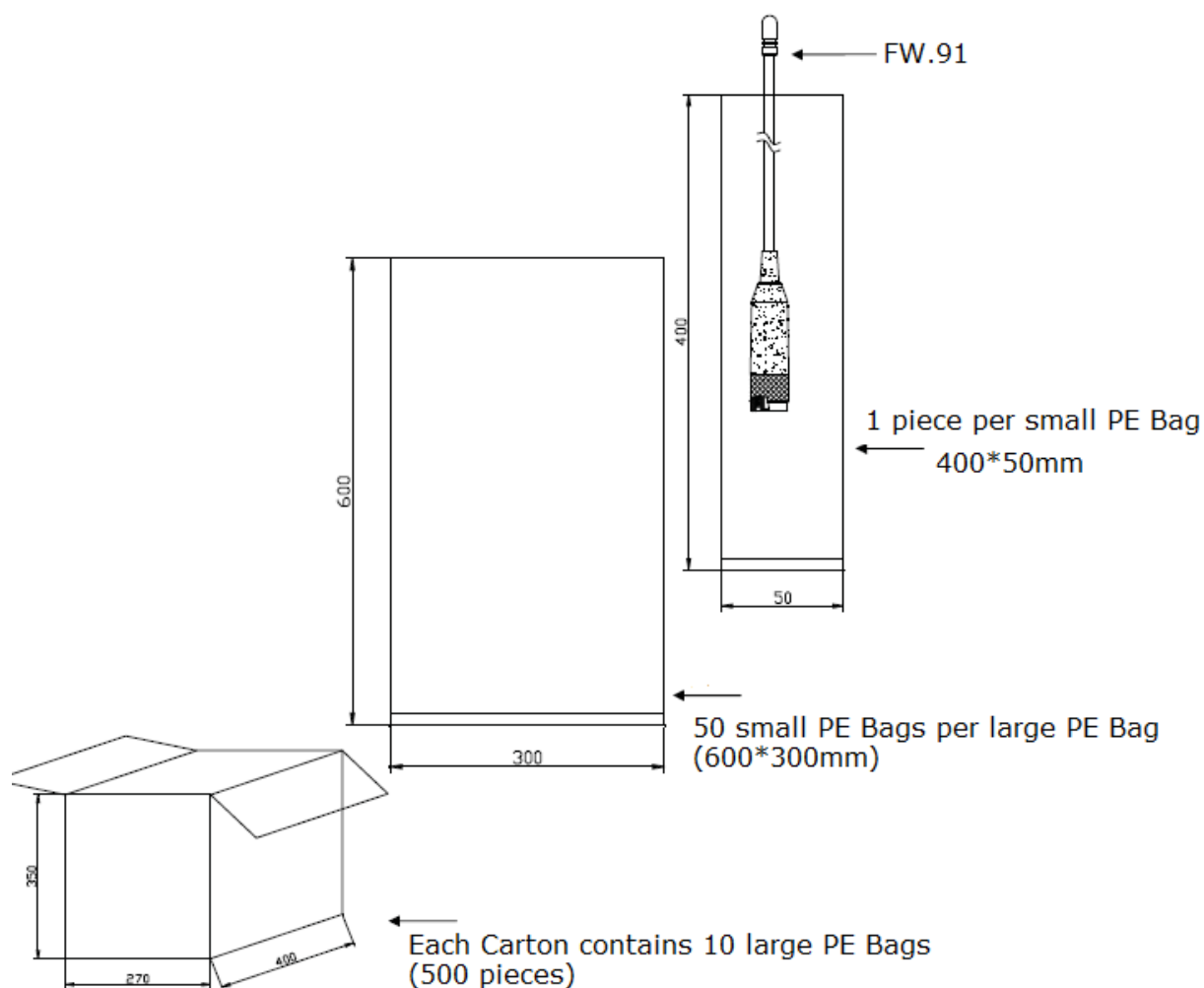

Taoglas makes no warranties based on the accuracy or completeness of the contents of this document and reserves the right to make changes to specifications and product descriptions at any time without notice.

Taoglas reserves all rights to this document and the information contained herein. Reproduction, use or disclosure to third parties without express permission is strictly prohibited. Copyright © 2012, Taoglas Ltd.