



Excellent Integrated System Limited

Stocking Distributor

Click to view price, real time Inventory, Delivery & Lifecycle Information:

[ITT Cannon, LLC](#)
[MS3101F20-4S](#)

For any questions, you can email us directly:

sales@integrated-circuit.com

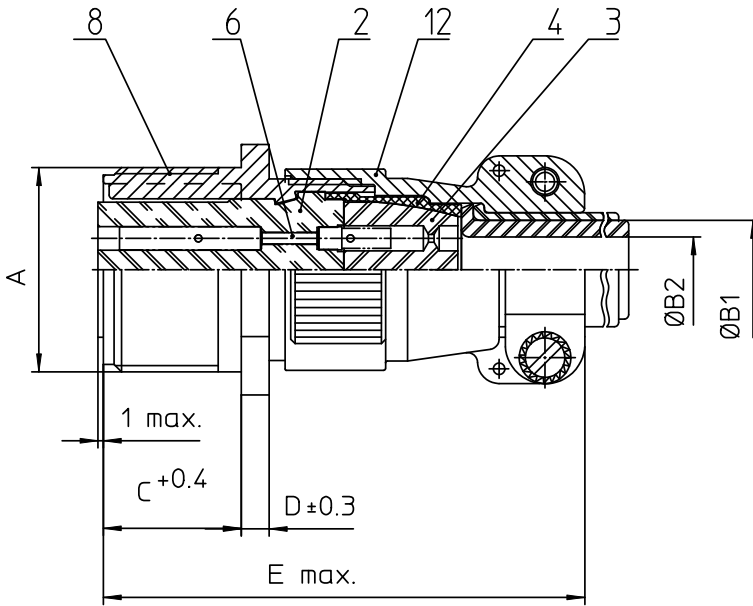

NO.	MASSE / DIMENSION
A	1 1/4-18NEF-2A
B1	15.9
B2	-
C	19
D	4
E	68
F	37.7
G	32.1

NO.	BESCHREIBUNG / DESCRIPTION
2	ISOLIERKÖRPER BUCHSE / INSULATOR SOCKET
3	DICHTKÖRPER / GROMMET
4	ENDRING / ENDRING
6	KONTAKTBUCHSE / CONTACT SOCKET
8	DOSENGEHÄUSE / SHELL
12	ENDGEHÄUSE / ENDBELL

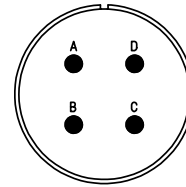

Note: Due to an automatic nomenclature system, numbers generated may not be sequential.
Specification and Dimensions subject to change
Drawings illustrate normal insulator positioning

Material Specification:	
Shell Material:	Aluminium alloy
Shell Plating:	Olive drab chromate coating over cadmium plating
Insulator Material:	Neoprene
Contact Material:	Copper alloy
Contact Plating:	Hard silver

all dimensions are in mm
Dimensions without tolerance indications are general tolerances in acc. with DIN7168m

drawing for
CUSTOMER



description MS3101F20-4S
Cable connecting plug
Endbell with clamp and bushing
Solder Cup / Socket / Layout: 20-4

© All rights reserved. Reproduction or use in third in any form
whenever is only permitted with written authorization of ITT Cannon  page 1/1 revision 377.3, Jul 16