

## **Excellent Integrated System Limited**

Stocking Distributor

Click to view price, real time Inventory, Delivery & Lifecycle Information:

[TT Electronics/Optek Technology](#)  
[OVM4RTX](#)

For any questions, you can email us directly:

[sales@integrated-circuit.com](mailto:sales@integrated-circuit.com)

# Hi-Reliability Visible LED Lamp (TO46)



## OVM4x, OVM4xTX, OVM4xTXV

- Hermetically sealed TO-46 package
- Choice of blue, green, red or yellow
- High-brightness with well-defined spatial radiation patterns
- ESD protection built in

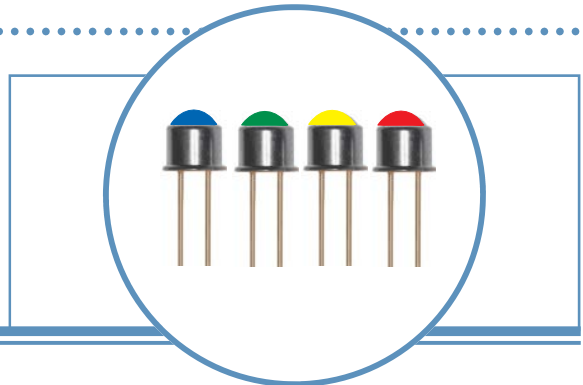

Each **OVM4x**, **OVM4xTX** and **OVM4xTXV** device is a high-reliability, high-sensitivity visible LED that is mounted in a hermetically sealed TO-46 package.

“Hi-Reliability” Visible LEDs function in the abnormally severe levels of mechanical, environmental and electrical stress that are typical of military and harsh industrial applications.

**OVM4xTX** and **OVM4xTXV** devices are processed to OPTEK’s 100% screening and QCI program-patterned after MIL-PRF-19500. Group A and B are performed on every lot. Group C is performed every six months.

### Applications

- Automotive exterior and interior lighting
- Architectural lighting
- Electronic signs and signals

Part Number	Part Number	Material	Emitted Color	Intensity Typ. (mcd)	Lens Color
OVM4BTX	OVM4BTXV	InGaN	Blue	2260	Clear Glass
OVM4GTX	OVM4GTXV	InGaN	Green	6520	Clear Glass
OVM4RTX	OVM4RTXV	AlInGaP	Red	3300	Clear Glass
OVM4YTX	OVM4YTXV	AlInGaP	Yellow	2010	Clear Glass

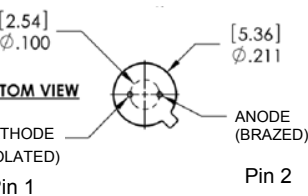
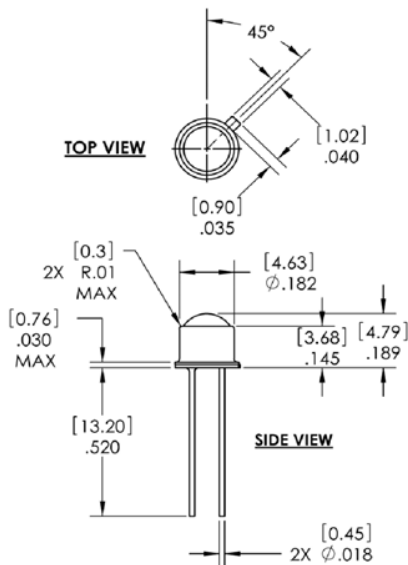

Pin 1	Cathode
Pin 2	Anode

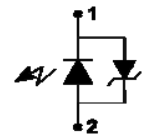

**DO NOT LOOK DIRECTLY AT LED WITH UNSHIELDED EYES OR DAMAGE TO RETINA MAY OCCUR.**

Dimensions are in inches [ mm]

OPTEK reserves the right to make changes at any time in order to improve design and to supply the best product possible.



# Hi-Reliability Visible LED Lamp

## OVM4x, OVM4xTX, OVM4xTXV



### Absolute Maximum Ratings

T<sub>A</sub> = 25° C unless otherwise noted

Storage Temperature Range	-65° C to +150° C
Operating Temperature Range	-55° C to +100° C
Reverse Voltage	5 V
Continuous Forward Current <sup>2</sup>	100 mA
Peak Forward Current (10% Duty Cycle, 1 KHz)	1.6 A
Power Dissipation	370 mW
Lead Soldering Temperature (3mm from the case) <sup>1</sup>	260° C
Current Linearity vs. Ambient Temperature	-0.2 mA/° C
LED Junction Temperature	115° C

Notes:

- Solder time less than 5 seconds at temperature extreme.
- Design of heat dissipation should be considered.

### Electrical Characteristics

T<sub>A</sub> = 25° C unless otherwise noted

SYMBOL	PARAMETER	MIN	TYP	MAX	UNITS	CONDITIONS	
I <sub>v</sub>	Luminous Intensity	Blue	----	2260	----	mcd	I <sub>F</sub> = 20 mA
		Green	----	6520	----		
		Red	----	3300	----		
		Yellow	----	2010	----		
V <sub>F</sub>	Forward Voltage	Blue	----	2.60	2.95	V	I <sub>F</sub> = 20 mA
		Green	----	2.60	2.95		
		Red	----	1.80	2.15		
		Yellow	----	1.80	2.15		
λ <sub>p</sub>	Peak Wavelength	Blue	----	463	----	nm	I <sub>F</sub> = 20 mA
		Green	----	530	----		
		Red	----	630	----		
		Yellow	----	591	----		
λ <sub>D</sub>	Dominant Wavelength	Blue	460	465	470	nm	I <sub>F</sub> = 20 mA
		Green	520	530	540		
		Red	619	624	629		
		Yellow	584	589	594		
Δλ	Spectral Half Width	Blue	----	22	----	nm	I <sub>F</sub> = 20 mA
		Green	----	35	----		
		Red	----	15	----		
		Yellow	----	18	----		
2 Θ ½	50% Power Angle	----	18	----	deg	I <sub>F</sub> = 20 mA	

Notes:

- All ranks will be included per delivery, rank ratio will be based on the chip distribution.
- To designate luminous intensity ranks, please contact OPTEK.
- Pb content <1000 PPM.

OPTEK reserves the right to make changes at any time in order to improve design and to supply the best product possible.

# Hi-Reliability Visible LED Lamp

## OVM4x, OVM4xTX, OVM4xTXV



### Typical Electro-Optical Characteristics Curves

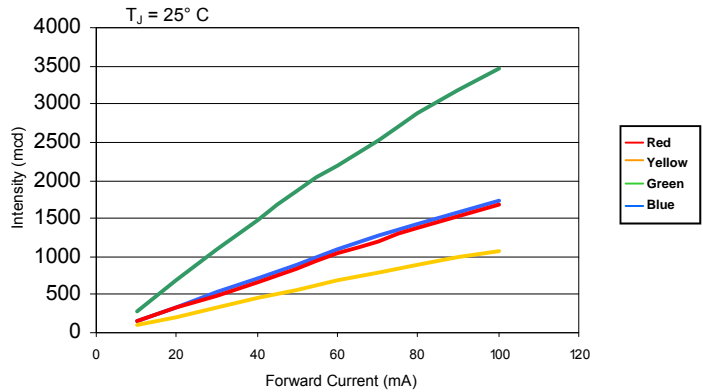
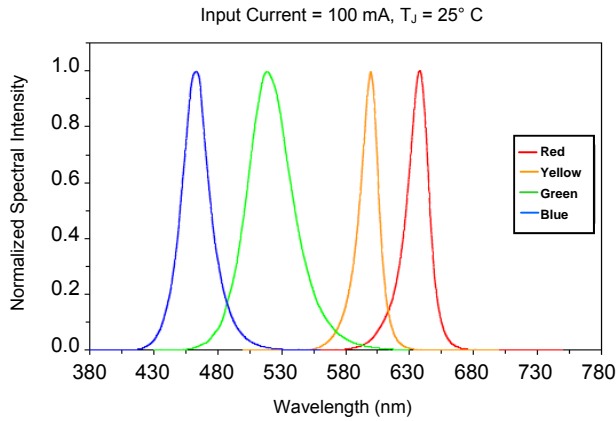

Intensity vs Forward Current

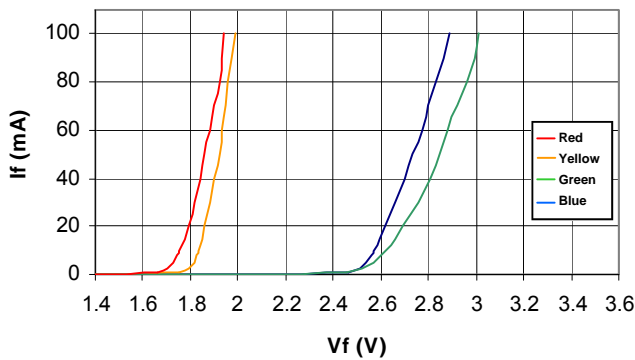

Forward Voltage vs Forward Current

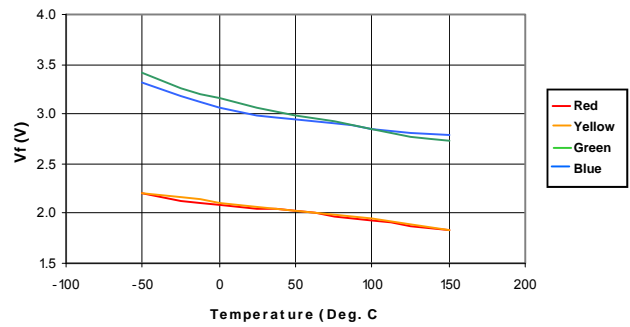

Forward Voltage vs Temperature

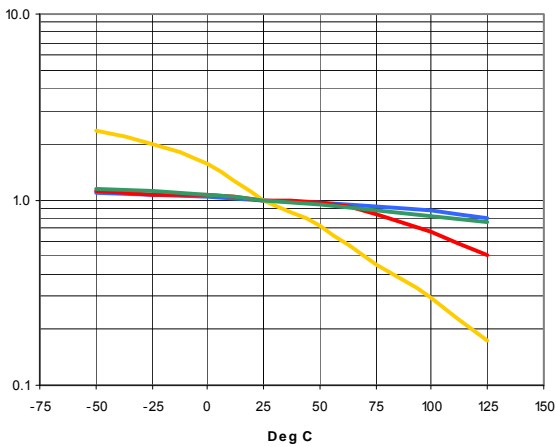

Relative Intensity vs Temperature

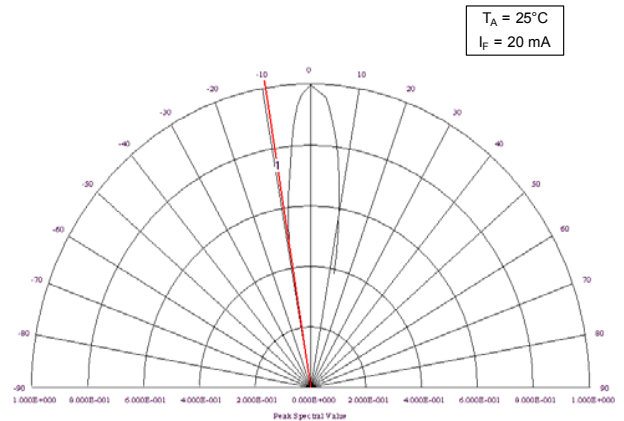

Spatial Intensity Distribution

OPTEK reserves the right to make changes at any time in order to improve design and to supply the best product possible.

# Hi-Reliability Visible LED Lamp

## OVM4x, OVM4xTX, OVM4xTXV



**Shipping Information:**

Optek UV LEDs are shipped in either of the below noted conductive trays made for ESD sensitive devices. Each tray contains up to 100 pieces and is then sealed in a plastic ESD bag. Tray dimensions are in inches (mm).

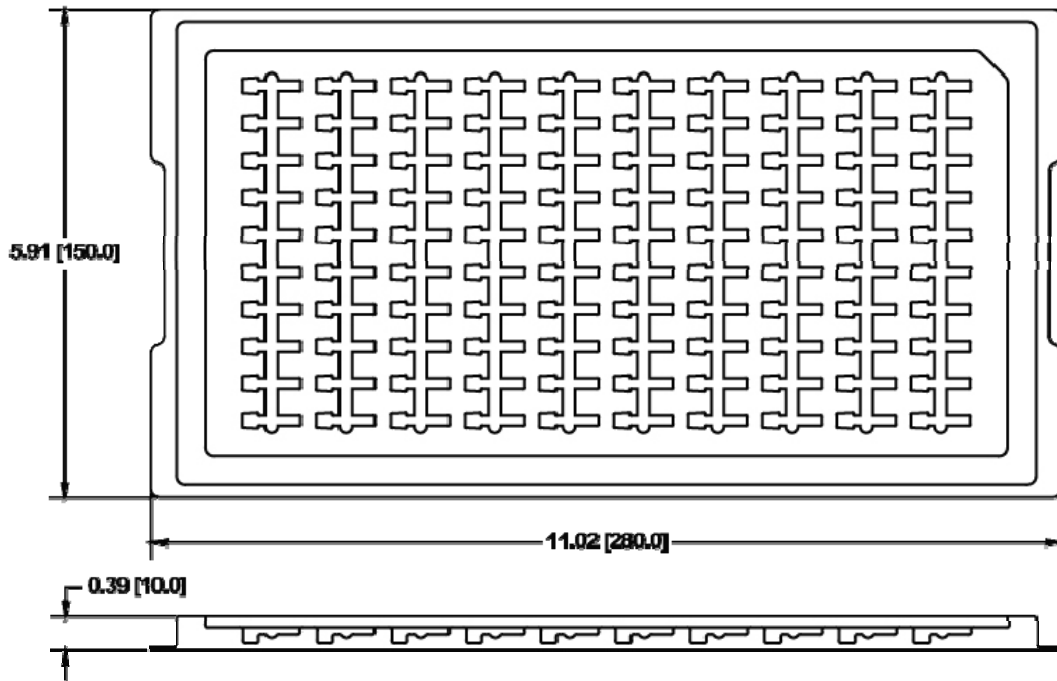
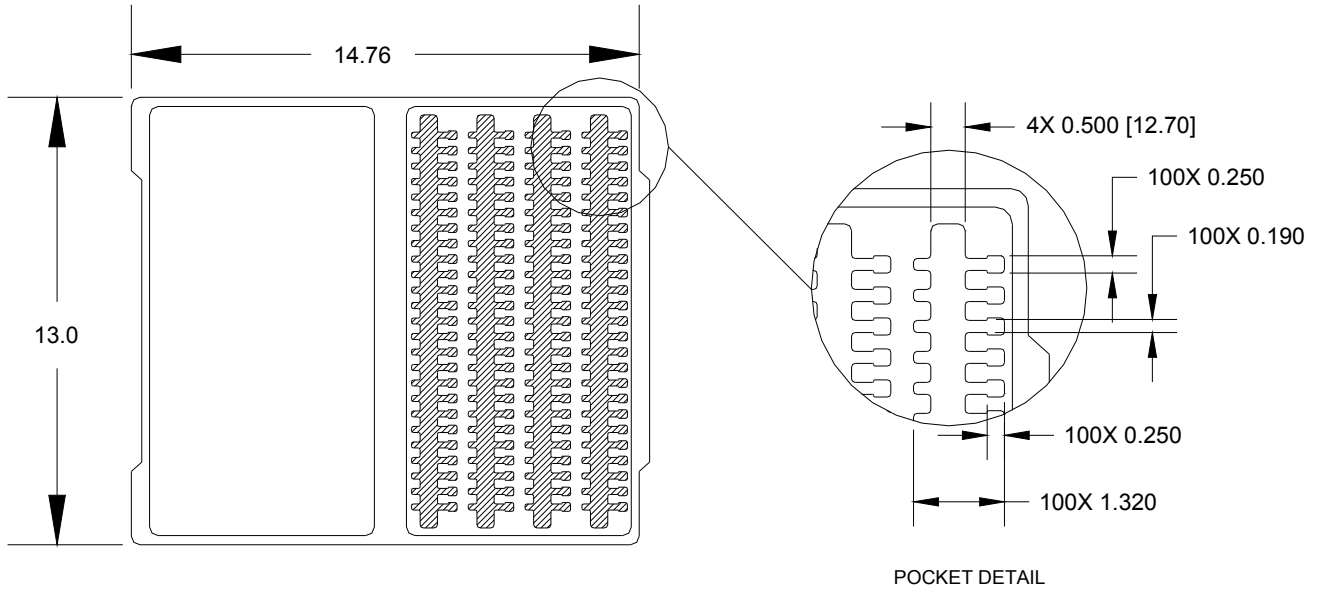

OPTEK reserves the right to make changes at any time in order to improve design and to supply the best product possible.