

## Excellent Integrated System Limited

Stocking Distributor

Click to view price, real time Inventory, Delivery & Lifecycle Information:

[STMicroelectronics](#)

[STTH200W06TV1](#)

For any questions, you can email us directly:

[sales@integrated-circuit.com](mailto:sales@integrated-circuit.com)



# STTH200W06TV1

## Turbo 2 ultrafast high voltage rectifier

Datasheet – production data

### Features

- Ultrafast switching
- Low reverse recovery current
- Low thermal resistance
- Reduces switching and conduction losses
- Insulated package
  - Insulating voltage = 2500 V rms
  - Capacitance = 45 pF
- Complies with UL standards (File ref: E81734)

### Description

The STTH200W06TV1, which uses ST Turbo 2, 600 V technology, is especially suited to be used for DC/AC and DC/AC converters in primary stage of MIG/MMA/TIG welding machine.

Packaged in ISOTOP, this device offers high power integration for all welding machines and industrial equipment.

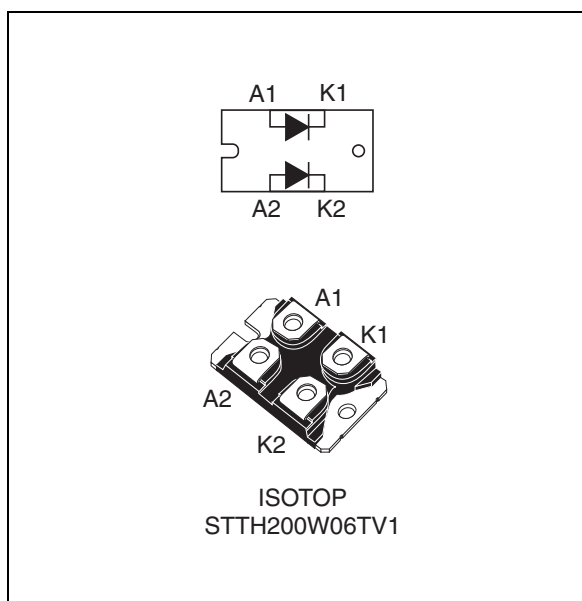

**Table 1. Device summary**

Symbol	Value
$I_{F(AV)}$	2 x 100 A
$V_{RRM}$	600 V
$T_j$ (max)	150 °C
$V_F$ (typ)	1.0 V
$t_{rr}$ (typ)	55 ns

Characteristics

STTH200W06TV1

# 1 Characteristics

**Table 2. Absolute ratings (limiting values at  $T_j = 25\text{ }^\circ\text{C}$ , unless otherwise specified, per diode)**

Symbol	Parameter		Value	Unit
$V_{RRM}$	Repetitive peak reverse voltage		600	V
$I_{F(RMS)}$	Forward rms current	Per diode	145	A
$I_{F(peak)}$	Average forward current, $\delta = 0.2$	Per diode $T_c = 105\text{ }^\circ\text{C}$	200	A
$I_{FSM}$	Surge non repetitive forward current	$t_p = 10\text{ ms}$ Sinusoidal	800	A
$T_{stg}$	Storage temperature range		-65 to + 150	$^\circ\text{C}$
$T_j$	Maximum operating junction temperature		150	$^\circ\text{C}$

**Table 3. Thermal parameters**

Symbol	Parameter		Value	Unit
$R_{th(j-c)}$	Junction to case	Per diode	0.7	$^\circ\text{C/W}$
		Total	0.4	
$R_{th(c)}$	Coupling		0.1	

When the two diodes 1 and 2 are used simultaneously:

$$\Delta T_j(\text{diode 1}) = P(\text{diode 1}) \times R_{th(j-c)} (\text{per diode}) + P(\text{diode 2}) \times R_{th(c)}$$

**Table 4. Static electrical characteristics (per diode)**

Symbol	Parameter	Test conditions		Min.	Typ.	Max.	Unit
$I_R^{(1)}$	Reverse leakage current	$T_j = 25\text{ }^\circ\text{C}$	$V_R = V_{RRM}$	-		30	$\mu\text{A}$
		$T_j = 125\text{ }^\circ\text{C}$		-	30	300	
$V_F^{(2)}$	Forward voltage drop	$T_j = 25\text{ }^\circ\text{C}$	$I_F = 100\text{ A}$			1.5	V
		$T_j = 150\text{ }^\circ\text{C}$		-	1	1.3	
		$T_j = 25\text{ }^\circ\text{C}$	$I_F = 200\text{ A}$	-		1.75	
		$T_j = 150\text{ }^\circ\text{C}$		-	1.25	1.60	

1. Pulse test:  $t_p = 5\text{ ms}$ ,  $\delta < 2\%$

2. Pulse test:  $t_p = 380\text{ }\mu\text{s}$ ,  $\delta < 2\%$

To evaluate the conduction losses use the following equation:

$$P = 1.0 \times I_{F(AV)} + 0.003 \times I_{F(RMS)}^2$$

**STTH200W06TV1**

**Characteristics**

**Table 5. Dynamic characteristics (per diode)**

Symbol	Parameter	Test conditions		Min.	Typ.	Max.	Unit
$I_{RM}$	Reverse recovery current	$T_j = 125^\circ\text{C}$	$I_F = 100\text{ A}, V_R = 400\text{ V}$ $di_F/dt = -200\text{ A}/\mu\text{s}$	-	30	40	A
$Q_{RR}$	Reverse recovery charge				4600		nC
$S_{factor}$	Softness factor				0.4		
$t_{rr}$	Reverse recovery time	$T_j = 25^\circ\text{C}$	$I_F = 1\text{ A}, V_R = 30\text{ V}$ $di_F/dt = -100\text{ A}/\mu\text{s}$	-	55	75	ns
$t_{fr}$	Forward recovery time	$T_j = 25^\circ\text{C}$	$I_F = 100\text{ A}, V_{FR} = 2.5\text{ V}$ $di_F/dt = 100\text{ A}/\mu\text{s}$	-		2000	ns
$V_{FP}$	Forward recovery voltage	$T_j = 25^\circ\text{C}$		-	3.3	5	V

**Figure 1. Average forward power dissipation versus average forward current (per diode)**

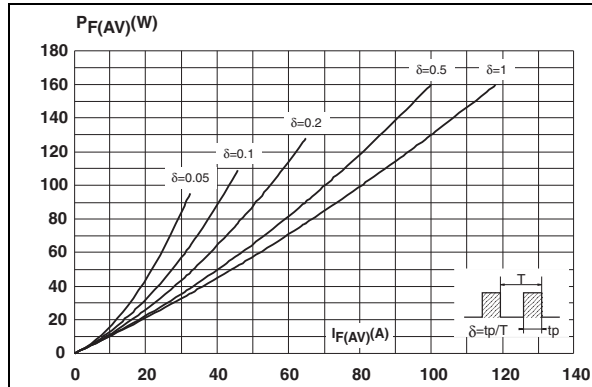

**Figure 2. Forward voltage drop versus forward current (per diode)**

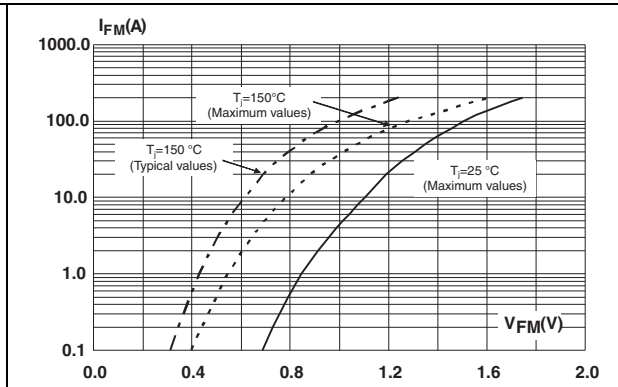

**Figure 3. Relative variation of thermal impedance, junction to case, versus pulse duration**

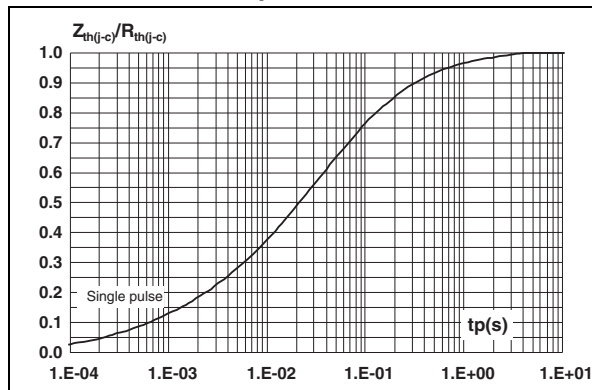

**Figure 4. Peak reverse recovery current versus di/dt (typical values, per diode)**

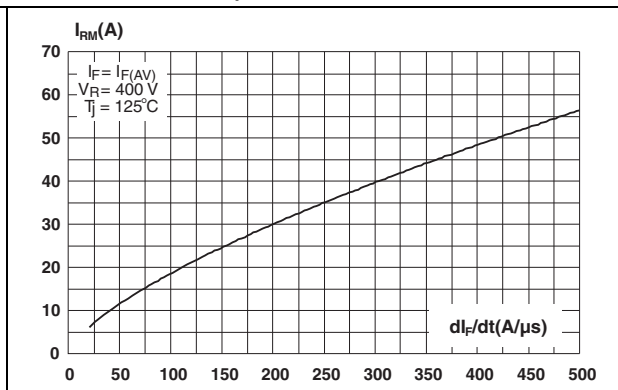

Characteristics

STTH200W06TV1

Figure 5. Reverse recovery time versus  $di_F/dt$  (typical values, per diode)

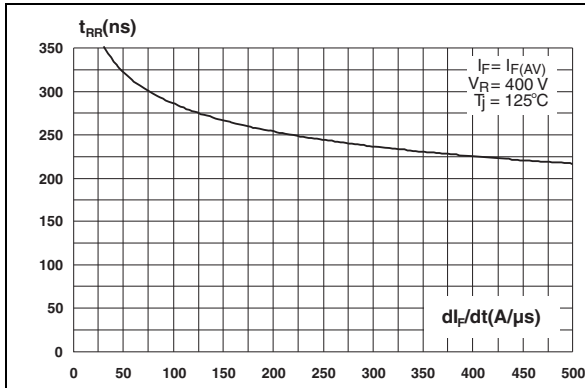

Figure 6. Reverse recovery charges versus  $di_F/dt$  (typical values, per diode)

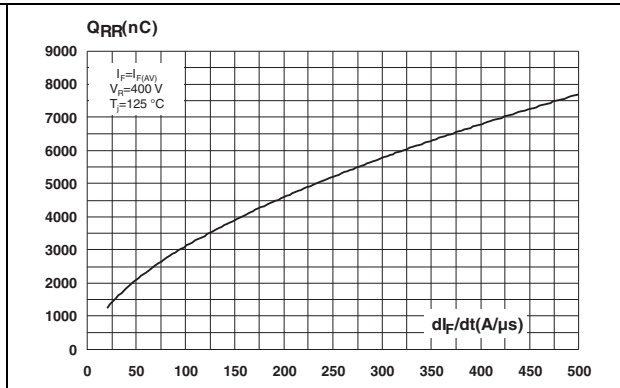

Figure 7. Reverse recovery softness factor versus  $di_F/dt$  (typical values, per diode)

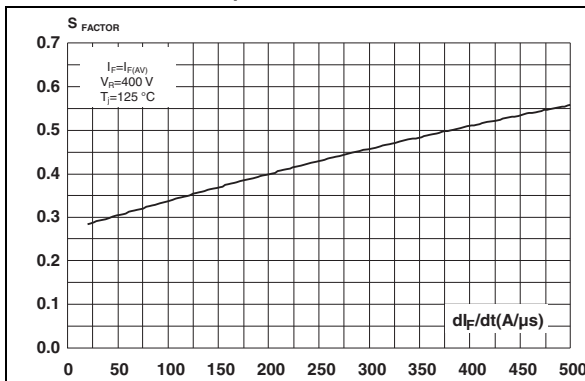

Figure 8. Relative variation of dynamic parameters versus junction temperature

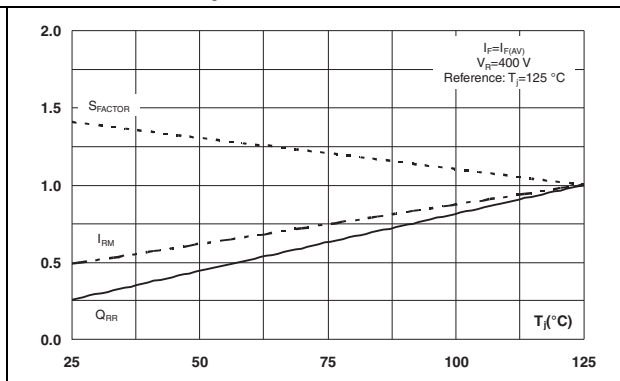

Figure 9. Transient peak forward voltage versus  $di_F/dt$  (typical values, per diode)

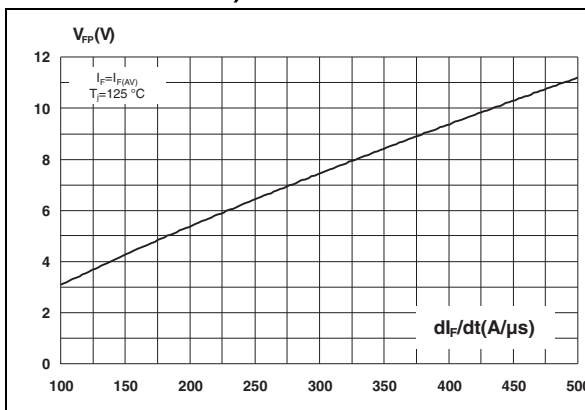
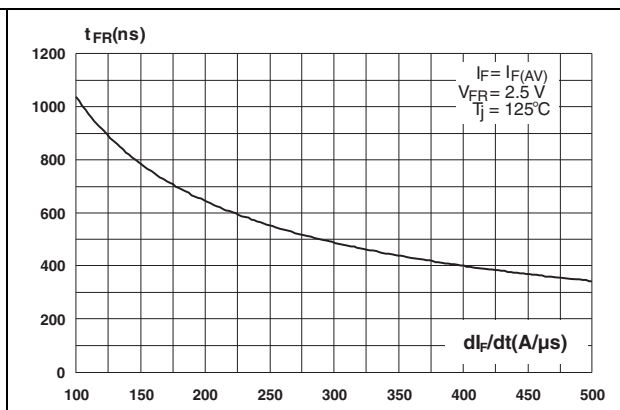

Figure 10. Forward recovery time versus  $di_F/dt$  (typical values, per diode)



**STTH200W06TV1**

**Characteristics**

**Figure 11. Junction capacitance versus reverse voltage applied (typical values, per diode)**

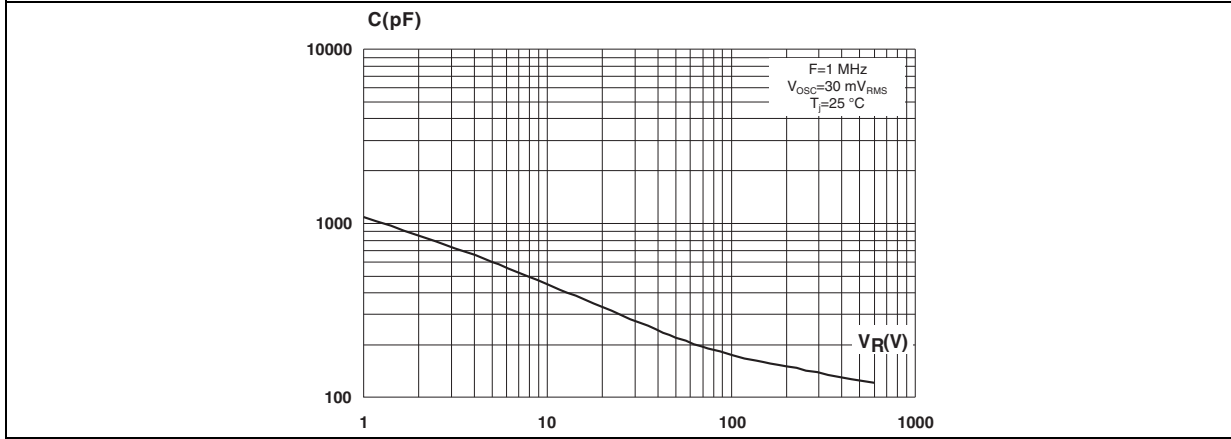

## 2 Ordering information scheme

Figure 12. Ordering information scheme

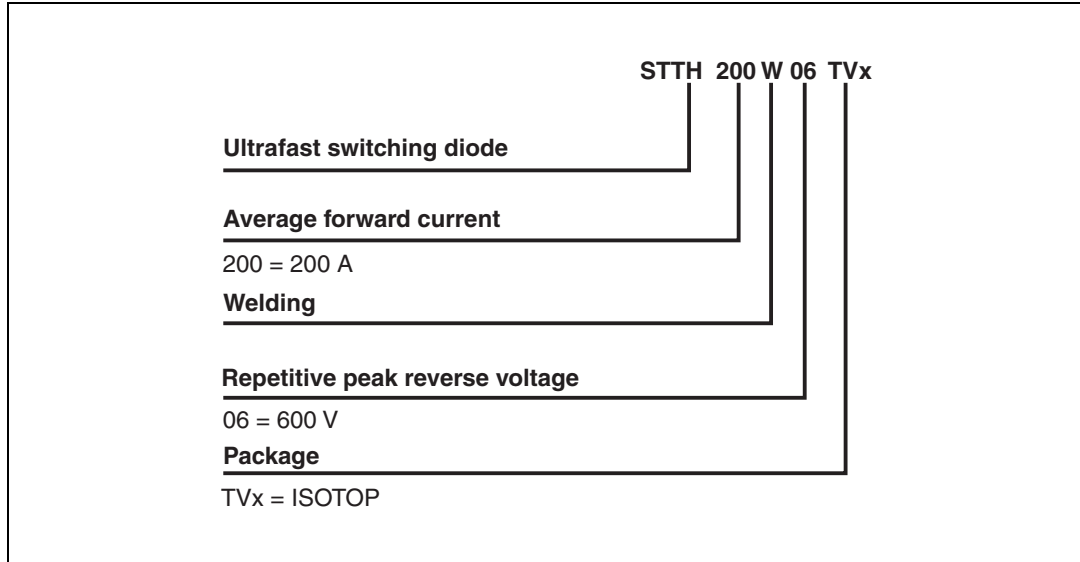

STTH200W06TV1

Package information

### 3 Package information

- Epoxy meets UL94, V0
- Cooling method: by conduction (C)
- Recommended torque value: 1.3 N·m (1.5 N·m maximum)

In order to meet environmental requirements, ST offers these devices in different grades of ECOPACK® packages, depending on their level of environmental compliance. ECOPACK® specifications, grade definitions and product status are available at: [www.st.com](http://www.st.com). ECOPACK® is an ST trademark.

Table 6. ISOTOP dimensions

Ref.	Dimensions			
	Millimeters		Inches	
	Min.	Max.	Min.	Max.
A	11.80	12.20	0.465	0.480
A1	8.90	9.10	0.350	0.358
B	7.8	8.20	0.307	0.323
C	0.75	0.85	0.030	0.033
C2	1.95	2.05	0.077	0.081
D	37.80	38.20	1.488	1.504
D1	31.50	31.70	1.240	1.248
E	25.15	25.50	0.990	1.004
E1	23.85	24.15	0.939	0.951
E2	24.80 typ.		0.976 typ.	
G	14.90	15.10	0.587	0.594
G1	12.60	12.80	0.496	0.504
G2	3.50	4.30	0.138	0.169
F	4.10	4.30	0.161	0.169
F1	4.60	5.00	0.181	0.197
P	4.00	4.30	0.157	0.69
P1	4.00	4.40	0.157	0.173
S	30.10	30.30	1.185	1.193

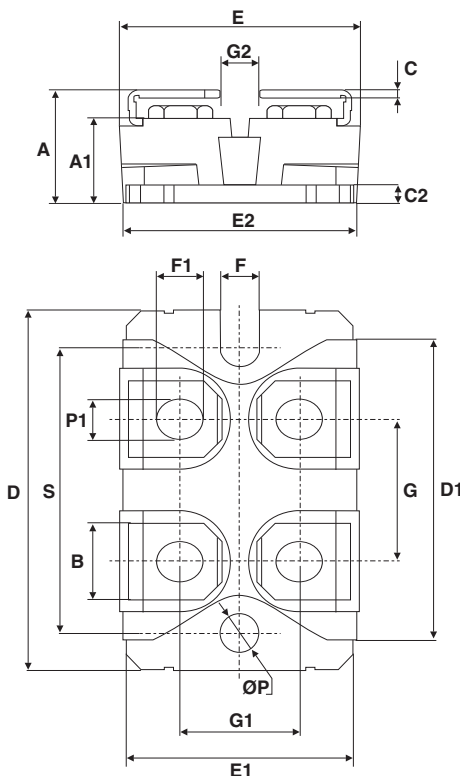



## 4 Ordering information

Table 7. Ordering information

Order code	Marking	Package	Weight	Base qty <sup>(1)</sup>	Delivery mode
STTH200W06TV1	STTH200W06TV1	ISOTOP	27 g	10 with screws	Tube

1. This product is supplied with 40 terminal screws and washers for each tube. The screws and washers are supplied in a separate pack with the order.

## 5 Revision history

Table 8. Document revision history

Date	Revision	Changes
05-Oct-2012	1	First issue

## STTH200W06TV1

---

### Please Read Carefully:

Information in this document is provided solely in connection with ST products. STMicroelectronics NV and its subsidiaries ("ST") reserve the right to make changes, corrections, modifications or improvements, to this document, and the products and services described herein at any time, without notice.

All ST products are sold pursuant to ST's terms and conditions of sale.

Purchasers are solely responsible for the choice, selection and use of the ST products and services described herein, and ST assumes no liability whatsoever relating to the choice, selection or use of the ST products and services described herein.

No license, express or implied, by estoppel or otherwise, to any intellectual property rights is granted under this document. If any part of this document refers to any third party products or services it shall not be deemed a license grant by ST for the use of such third party products or services, or any intellectual property contained therein or considered as a warranty covering the use in any manner whatsoever of such third party products or services or any intellectual property contained therein.

**UNLESS OTHERWISE SET FORTH IN ST'S TERMS AND CONDITIONS OF SALE ST DISCLAIMS ANY EXPRESS OR IMPLIED WARRANTY WITH RESPECT TO THE USE AND/OR SALE OF ST PRODUCTS INCLUDING WITHOUT LIMITATION IMPLIED WARRANTIES OF MERCHANTABILITY, FITNESS FOR A PARTICULAR PURPOSE (AND THEIR EQUIVALENTS UNDER THE LAWS OF ANY JURISDICTION), OR INFRINGEMENT OF ANY PATENT, COPYRIGHT OR OTHER INTELLECTUAL PROPERTY RIGHT.**

**UNLESS EXPRESSLY APPROVED IN WRITING BY TWO AUTHORIZED ST REPRESENTATIVES, ST PRODUCTS ARE NOT RECOMMENDED, AUTHORIZED OR WARRANTED FOR USE IN MILITARY, AIR CRAFT, SPACE, LIFE SAVING, OR LIFE SUSTAINING APPLICATIONS, NOR IN PRODUCTS OR SYSTEMS WHERE FAILURE OR MALFUNCTION MAY RESULT IN PERSONAL INJURY, DEATH, OR SEVERE PROPERTY OR ENVIRONMENTAL DAMAGE. ST PRODUCTS WHICH ARE NOT SPECIFIED AS "AUTOMOTIVE GRADE" MAY ONLY BE USED IN AUTOMOTIVE APPLICATIONS AT USER'S OWN RISK.**

Resale of ST products with provisions different from the statements and/or technical features set forth in this document shall immediately void any warranty granted by ST for the ST product or service described herein and shall not create or extend in any manner whatsoever, any liability of ST.

ST and the ST logo are trademarks or registered trademarks of ST in various countries.

Information in this document supersedes and replaces all information previously supplied.

The ST logo is a registered trademark of STMicroelectronics. All other names are the property of their respective owners.

© 2012 STMicroelectronics - All rights reserved

STMicroelectronics group of companies

Australia - Belgium - Brazil - Canada - China - Czech Republic - Finland - France - Germany - Hong Kong - India - Israel - Italy - Japan - Malaysia - Malta - Morocco - Philippines - Singapore - Spain - Sweden - Switzerland - United Kingdom - United States of America

[www.st.com](http://www.st.com)