

Excellent Integrated System Limited

Stocking Distributor

Click to view price, real time Inventory, Delivery & Lifecycle Information:

[NXP Semiconductors](#)

[MRF8P9210NR3](#)

For any questions, you can email us directly:

sales@integrated-circuit.com

Freescale Semiconductor

Technical Data

RF Power LDMOS Transistor

N-Channel Enhancement-Mode Lateral MOSFET

Designed for CDMA base station applications with frequencies from 920 to 960 MHz. Can be used in Class AB and Class C for all typical cellular base station modulation formats.

- Typical Doherty Single-Carrier W-CDMA Characterization Performance: $V_{DD} = 28$ Volts, $I_{DQA} = 750$ mA, $V_{GSB} = 1.2$ Vdc, $P_{out} = 63$ Watts Avg., IQ Magnitude Clipping, Channel Bandwidth = 3.84 MHz, Input Signal PAR = 7.5 dB @ 0.01% Probability on CCDF.

Frequency	G_{ps} (dB)	η_D (%)	Output PAR (dB)	ACPR (dBc)
920 MHz	16.5	46.2	6.2	-31.3
940 MHz	16.9	47.7	6.0	-32.6
960 MHz	16.7	47.4	5.8	-34.4

- Capable of Handling 10:1 VSWR, @ 32 Vdc, 960 MHz, 253 Watts CW (1) Output Power (3 dB Input Overdrive from Rated P_{out}), Designed for Enhanced Ruggedness
- Typical P_{out} @ 3 dB Compression Point \approx 290 Watts (2)

Features

- Production Tested in a Symmetrical Doherty Configuration
- 100% PAR Tested for Guaranteed Output Power Capability
- Characterized with Large-Signal Load-Pull Parameters and Common Source S-Parameters
- Internally Matched for Ease of Use
- Integrated ESD Protection
- Greater Negative Gate-Source Voltage Range for Improved Class C Operation
- Designed for Digital Predistortion Error Correction Systems
- 225°C Capable Plastic Package
- In Tape and Reel. R3 Suffix = 250 Units per 32 mm, 13 inch Reel.

MRF8P9210NR3

920-960 MHz, 63 W AVG., 28 V SINGLE W-CDMA RF POWER LDMOS TRANSISTOR

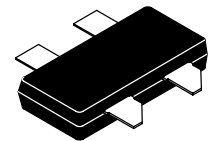

CASE 2023-02
OM-780-4
PLASTIC

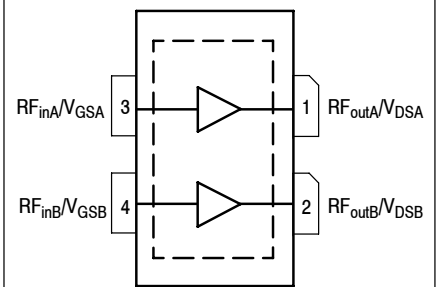

(Top View)

Note: Exposed backside of the package is the source terminal for the transistors.

Figure 1. Pin Connections

Table 1. Maximum Ratings

Rating	Symbol	Value	Unit
Drain-Source Voltage	V_{DSS}	-0.5, +70	Vdc
Gate-Source Voltage	V_{GS}	-6.0, +10	Vdc
Operating Voltage	V_{DD}	32, +0	Vdc
Storage Temperature Range	T_{stg}	-65 to +150	°C
Case Operating Temperature	T_C	150	°C
Operating Junction Temperature (3,4)	T_J	225	°C
CW Operation @ $T_C = 25^\circ\text{C}$ Derate above 25°C	CW	239 1.74	W W/°C

- Exceeds recommended operating conditions. See CW operation data in Maximum Ratings table.
- $P_{3dB} = P_{avg} + 7.0$ dB where P_{avg} is the average output power measured using an unclipped W-CDMA single-carrier input signal where output PAR is compressed to 7.0 dB @ 0.01% probability on CCDF.
- Continuous use at maximum temperature will affect MTTF.
- MTTF calculator available at <http://www.freescale.com/rf>. Select Software & Tools/Development Tools/Calculators to access MTTF calculators by product.

Table 2. Thermal Characteristics

Characteristic	Symbol	Value (1,2)	Unit
Thermal Resistance, Junction to Case Case Temperature 65°C, 63 W CW, 28 Vdc, I _{DQA} = 750 mA, V _{GSB} = 1.2 Vdc, 960 MHz Case Temperature 85°C, 200 W CW ⁽³⁾ , 28 Vdc, I _{DQA} = 750 mA, V _{GSB} = 1.2 Vdc, 960 MHz	R _{θJC}	0.53 0.35	°C/W

Table 3. ESD Protection Characteristics

Test Methodology	Class
Human Body Model (per JESD22-A114)	2
Machine Model (per EIA/JESD22-A115)	B
Charge Device Model (per JESD22-C101)	IV

Table 4. Moisture Sensitivity Level

Test Methodology	Rating	Package Peak Temperature	Unit
Per JESD22-A113, IPC/JEDEC J-STD-020	3	260	°C

Table 5. Electrical Characteristics (T_A = 25°C unless otherwise noted)

Characteristic	Symbol	Min	Typ	Max	Unit
----------------	--------	-----	-----	-----	------

Off Characteristics ⁽⁴⁾

Zero Gate Voltage Drain Leakage Current (V _{DS} = 70 Vdc, V _{GS} = 0 Vdc)	I _{DSS}	—	—	10	μAdc
Zero Gate Voltage Drain Leakage Current (V _{DS} = 28 Vdc, V _{GS} = 0 Vdc)	I _{DSS}	—	—	1	μAdc
Gate-Source Leakage Current (V _{GS} = 5 Vdc, V _{DS} = 0 Vdc)	I _{GSS}	—	—	1	μAdc

On Characteristics ⁽⁴⁾

Gate Threshold Voltage (V _{DS} = 10 Vdc, I _D = 800 μAdc)	V _{GS(th)}	1.5	2.3	3.0	Vdc
Gate Quiescent Voltage (V _{DD} = 28 Vdc, I _{DA} = 750 mAdc, Measured in Functional Test)	V _{GS(Q)}	2.4	3.2	3.9	Vdc
Drain-Source On-Voltage (V _{GS} = 10 Vdc, I _D = 3.3 Adc)	V _{DS(on)}	0.1	0.24	0.3	Vdc

Functional Tests ^(5,6) (In Freescale Doherty Production Test Fixture, 50 ohm system) V_{DD} = 28 Vdc, I_{DQA} = 750 mA, V_{GSB} = 1.2 Vdc, P_{out} = 63 W Avg., f = 960 MHz, Single-Carrier W-CDMA, IQ Magnitude Clipping, Input Signal PAR = 7.5 dB @ 0.01% Probability on CCDF. ACPR measured in 3.84 MHz Channel Bandwidth @ ±5 MHz Offset.

Power Gain	G _{ps}	15.3	16.8	18.3	dB
Drain Efficiency	η _D	41.0	46.7	—	%
Output Peak-to-Average Ratio @ 0.01% Probability on CCDF	PAR	5.5	5.8	—	dB
Adjacent Channel Power Ratio	ACPR	—	-35.5	-32.0	dBc

Typical Broadband Performance (In Freescale Doherty Characterization Test Fixture, 50 ohm system) V_{DD} = 28 Vdc, I_{DQA} = 750 mA, V_{GSB} = 1.2 Vdc, P_{out} = 63 W Avg., Single-Carrier W-CDMA, IQ Magnitude Clipping, Input Signal PAR = 7.5 dB @ 0.01% Probability on CCDF. ACPR measured in 3.84 MHz Channel Bandwidth @ ±5 MHz Offset.

Frequency	G _{ps} (dB)	η _D (%)	Output PAR (dB)	ACPR (dBc)
920 MHz	16.5	46.2	6.2	-31.3
940 MHz	16.9	47.7	6.0	-32.6
960 MHz	16.7	47.4	5.8	-34.4

1. MTTF calculator available at <http://www.freescale.com/rf>. Select Software & Tools/Development Tools/Calculators to access MTTF calculators by product.
2. Refer to AN1955, *Thermal Measurement Methodology of RF Power Amplifiers*. Go to <http://www.freescale.com/rf>. Select Documentation/Application Notes - AN1955.
3. Exceeds recommended operating conditions. See CW operation data in Maximum Ratings table.
4. Each side of device measured separately.
5. Part internally matched both on input and output.
6. Measurement made with device in a Symmetrical Doherty configuration.

(continued)

Table 5. Electrical Characteristics ($T_A = 25^\circ\text{C}$ unless otherwise noted) (continued)

Characteristic	Symbol	Min	Typ	Max	Unit
Typical Performances (In Freescale Doherty Characterization Test Fixture, 50 ohm system) $V_{DD} = 28\text{ Vdc}$, $I_{DQA} = 750\text{ mA}$, $V_{GSB} = 1.2\text{ Vdc}$, 920–960 MHz Bandwidth					
P_{out} @ 1 dB Compression Point, CW	P1dB	—	193	—	W
P_{out} @ 3 dB Compression Point (1)	P3dB	—	290	—	W
IMD Symmetry @ 80 W PEP, P_{out} where IMD Third Order Intermodulation $\cong 30\text{ dBc}$ (Delta IMD Third Order Intermodulation between Upper and Lower Sidebands $> 2\text{ dB}$)	IMD _{sym}	—	10	—	MHz
VBW Resonance Point (IMD Third Order Intermodulation Inflection Point)	VBW _{res}	—	64	—	MHz
Gain Flatness in 40 MHz Bandwidth @ $P_{out} = 63\text{ W Avg.}$	G _F	—	0.4	—	dB
Gain Variation over Temperature (-30°C to $+85^\circ\text{C}$)	ΔG	—	0.017	—	dB/ $^\circ\text{C}$
Output Power Variation over Temperature (-30°C to $+85^\circ\text{C}$) (2)	$\Delta P1\text{dB}$	—	0.0018	—	dB/ $^\circ\text{C}$

1. P3dB = $P_{avg} + 7.0\text{ dB}$ where P_{avg} is the average output power measured using an unclipped W-CDMA single-carrier input signal where output PAR is compressed to 7.0 dB @ 0.01% probability on CCDF.
2. Exceeds recommended operating conditions. See CW operation data in Maximum Ratings table.

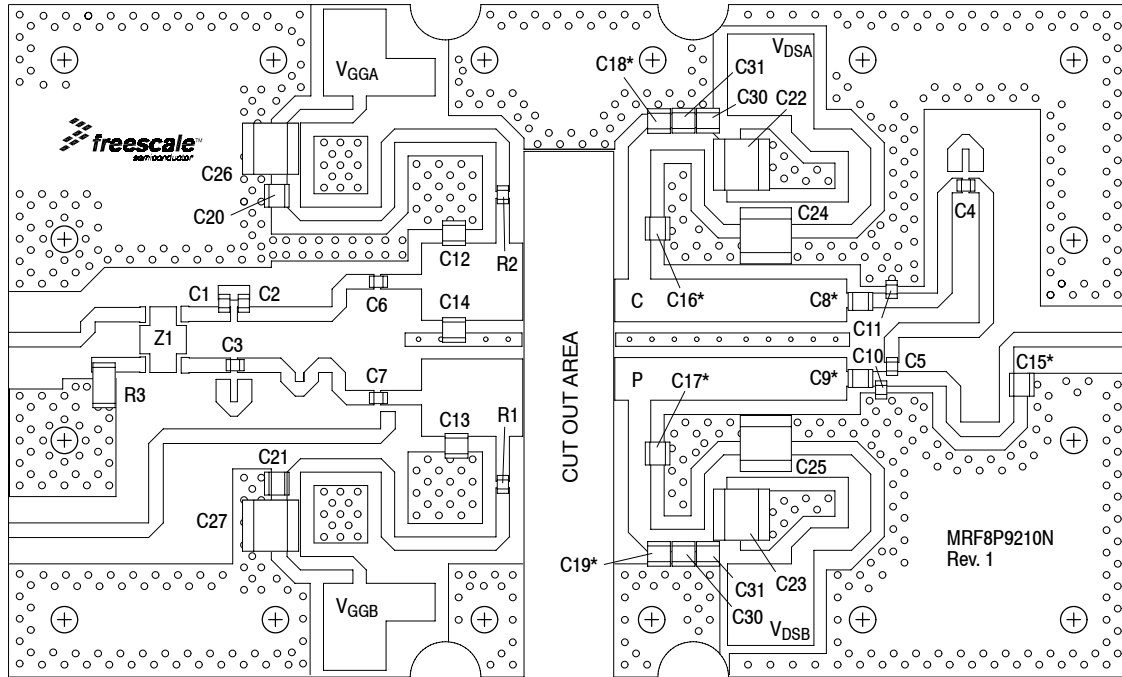

*C8, C9, C15, C16, C17, C18, and C19 are mounted vertically.

Figure 1. MRF8P9210NR3 Production Test Circuit Component Layout

Table 6. MRF8P9210NR3 Production Test Circuit Component Designations and Values

Part	Description	Part Number	Manufacturer
C1, C2, C3, C4, C5	100 pF Chip Capacitors	ATC600F101JT250XT	ATC
C6, C7	30 pF Chip Capacitors	ATC600F300JT250XT	ATC
C8	24 pF Chip Capacitor	ATC100B240JT500XT	ATC
C9	30 pF Chip Capacitor	ATC100B300JT500XT	ATC
C10	4.3 pF Chip Capacitor	ATC600F4R3BT250XT	ATC
C11	3.9 pF Chip Capacitor	ATC600F3R9BT250XT	ATC
C12	7.5 pF Chip Capacitor	ATC100B7R5CT500XT	ATC
C13	8.2 pF Chip Capacitor	ATC100B8R2CT500XT	ATC
C14	1.5 pF Chip Capacitor	ATC800B1R5BT500XT	ATC
C15	2.0 pF Chip Capacitor	ATC800B2R0BT500XT	ATC
C16, C17	9.1 pF Chip Capacitors	ATC100B9R1CT500XT	ATC
C18, C19	47 pF Chip Capacitors	ATC100B470JT500XT	ATC
C20, C21	200 pF Chip Capacitors	ATC800B201JT300XT	ATC
C22, C23, C24, C25, C26, C27	10 μ F, 50 V Chip Capacitors	GRM55DR61H106KA88L	Murata
C28, C29, C30, C31	2.2 μ F, 100 V Chip Capacitors	GRM32ER72A225KA35L	Murata
R1, R2	2.37 Ω , 1/4 W Chip Resistors	CRCW12062R37FNEA	Vishay
R3	50 Ω , 10 W Chip Resistor	82-7034	Florida RF Labs
Z1	815-960 MHz Band 90°, 3 dB Hybrid Coupler	GSC362-HYB0900	Soshin
PCB	0.030", $\epsilon_r = 3.5$	RF35A2	Taconic

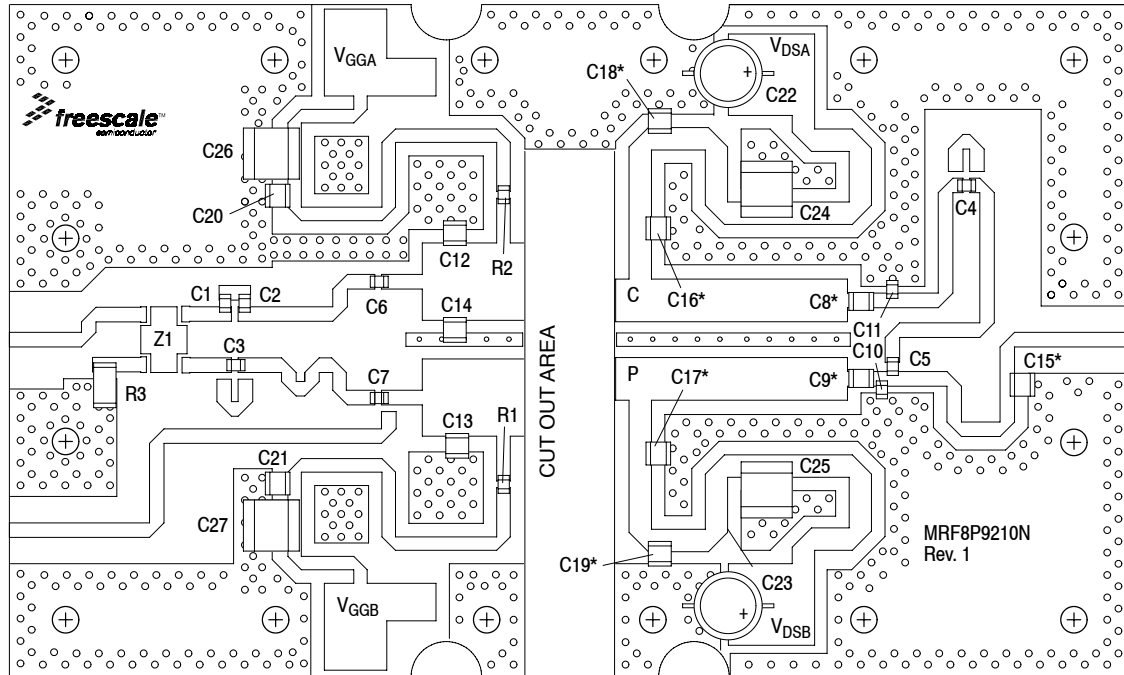

*C8, C9, C15, C16, C17, C18, and C19 are mounted vertically.

Figure 2. MRF8P9210NR3 Characterization Test Circuit Component Layout

Table 7. MRF8P9210NR3 Characterization Test Circuit Component Designations and Values

Part	Description	Part Number	Manufacturer
C1, C2, C3, C4, C5	100 pF Chip Capacitors	ATC600F101JT250XT	ATC
C6, C7	30 pF Chip Capacitors	ATC600F300JT250XT	ATC
C8	24 pF Chip Capacitors	ATC100B240JT500XT	ATC
C9	30 pF Chip Capacitors	ATC100B300JT500XT	ATC
C10	4.3 pF Chip Capacitors	ATC600F4R3BT250XT	ATC
C11	3.9 pF Chip Capacitors	ATC600F3R9BT250XT	ATC
C12	7.5 pF Chip Capacitors	ATC100B7R5CT500XT	ATC
C13	8.2 pF Chip Capacitors	ATC100B8R2CT500XT	ATC
C14	1.5 pF Chip Capacitors	ATC800B1R5BT500XT	ATC
C15	2.0 pF Chip Capacitors	ATC800B2R0BT500XT	ATC
C16, C17	9.1 pF Chip Capacitors	ATC100B9R1CT500XT	ATC
C18, C19	47 pF Chip Capacitors	ATC100B470JT500XT	ATC
C20, C21	200 pF Chip Capacitors	ATC800B201JT300XT	ATC
C22, C23	220 μ F Electrolytic Capacitor	MCGPR100V227M16X26-RH	Multicom
C24, C25, C26, C27	10 μ F, 50 V Chip Capacitors	GRM55DR61H106KA88L	Murata
R1, R2	2.37 Ω , 1/4 W Chip Resistors	CRCW12062R37FNEA	Vishay
R3	50 Ω , 10 W Chip Resistor	82-7034	Florida RF Labs
Z1	815-960 MHz Band 90°, 3 dB Hybrid Coupler	GSC362-HYB0900	Soshin
PCB	0.030", $\epsilon_r = 3.5$	RF35A2	Taconic

TYPICAL CHARACTERISTICS

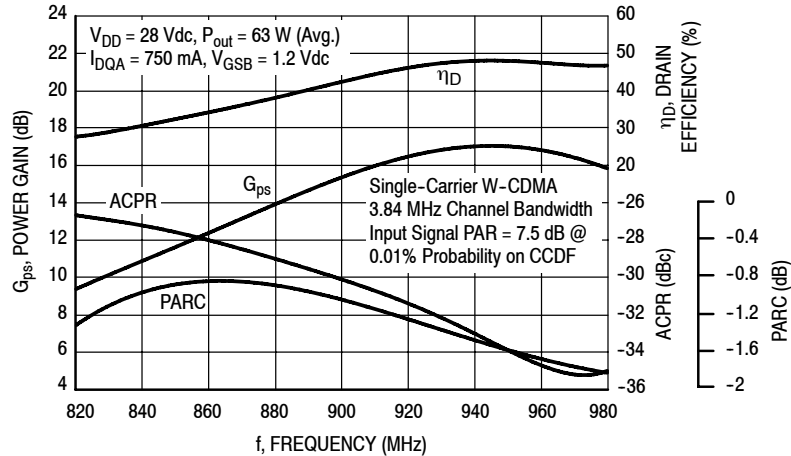

Figure 3. Output Peak-to-Average Ratio Compression (PARC) Broadband Performance @ $P_{out} = 63$ Watts Avg.

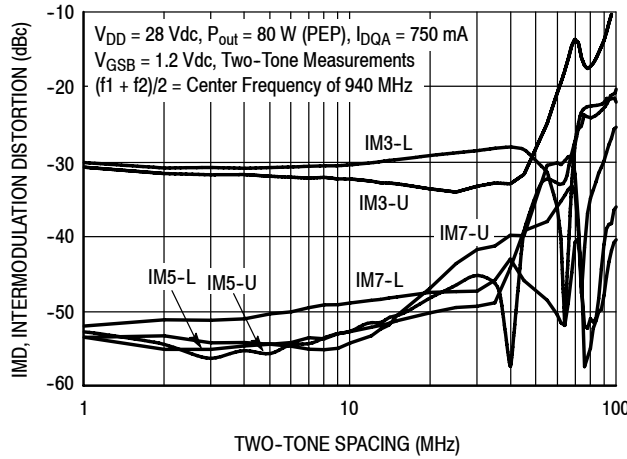

Figure 4. Intermodulation Distortion Products versus Two-Tone Spacing

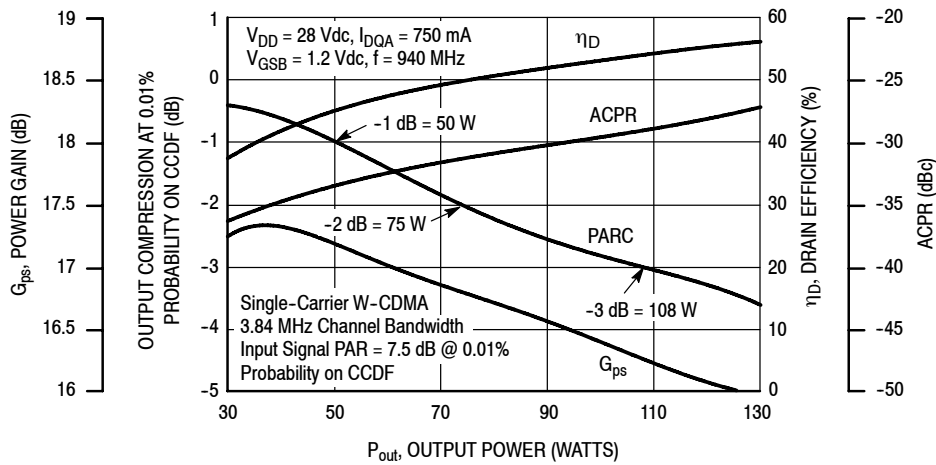

Figure 5. Output Peak-to-Average Ratio Compression (PARC) versus Output Power

TYPICAL CHARACTERISTICS

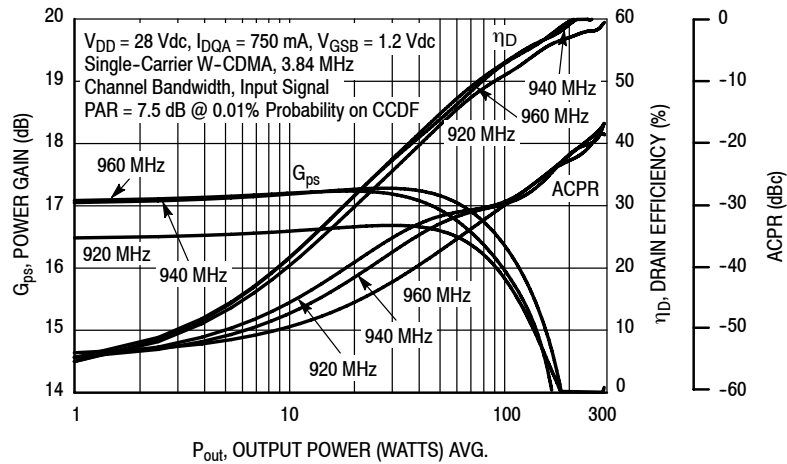

Figure 6. Single-Carrier W-CDMA Power Gain, Drain Efficiency and ACPR versus Output Power

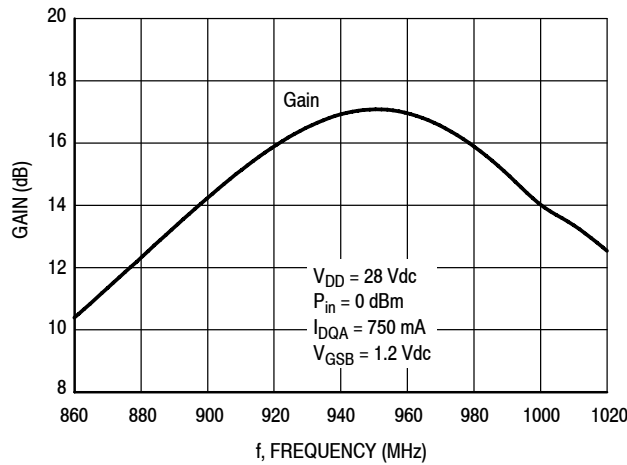

Figure 7. Broadband Frequency Response

W-CDMA TEST SIGNAL

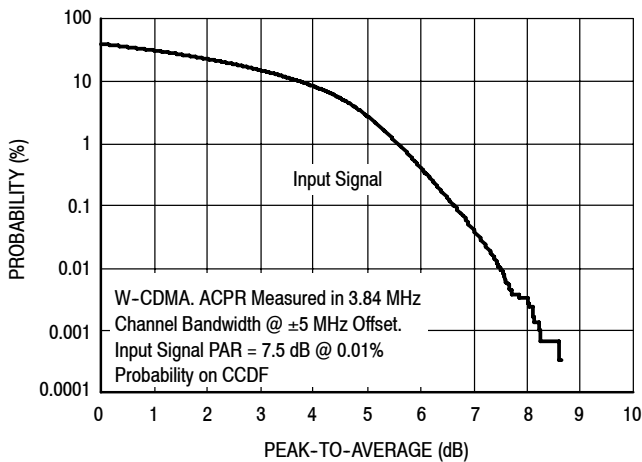

Figure 8. CCDF W-CDMA IQ Magnitude Clipping, Single-Carrier Test Signal

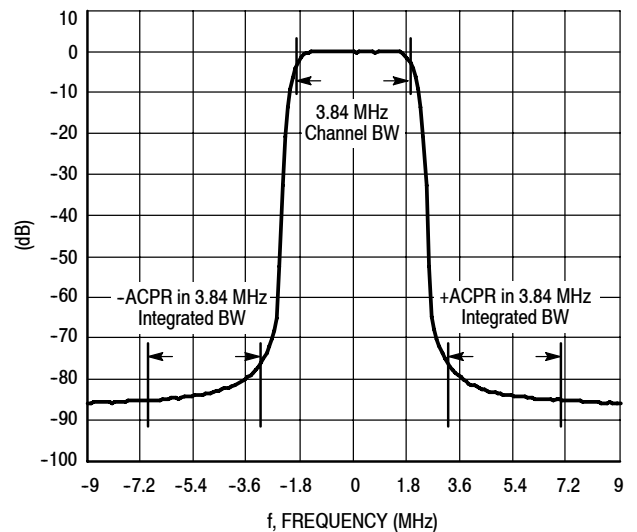

Figure 9. Single-Carrier W-CDMA Spectrum

$V_{DD} = 28 \text{ Vdc}$, $I_{DQA} = 750 \text{ mA}$, Pulsed CW, 10 $\mu\text{sec}(\text{on})$, 10% Duty Cycle

f (MHz)	Z_{source} (Ω)	$Z_{\text{load}}^{(1)}$ (Ω)	Max Output Power					
			P1dB			P3dB		
			(dBm)	(W)	η_D (%)	(dBm)	(W)	η_D (%)
920	2.22 - j5.54	9.84 - j1.33	52.0	159	55.7	52.9	195	59.0
940	2.76 - j6.09	9.66 + j0.60	52.0	159	55.9	52.9	195	59.7
960	2.82 - j6.71	8.91 + j1.96	51.9	155	55.9	52.8	191	60.1

(1) Load impedance for optimum P1dB power.

Z_{source} = Impedance as measured from gate contact to ground.

Z_{load} = Impedance as measured from drain contact to ground.

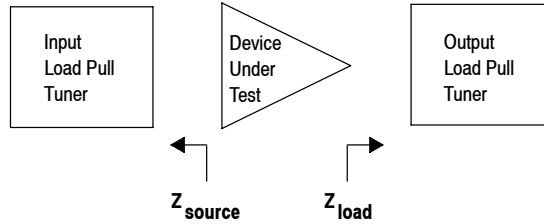

Figure 10. Carrier Side Load Pull Performance — Maximum P1dB Tuning

$V_{DD} = 28 \text{ Vdc}$, $I_{DQA} = 750 \text{ mA}$, Pulsed CW, 10 $\mu\text{sec}(\text{on})$, 10% Duty Cycle

f (MHz)	Z_{source} (Ω)	$Z_{\text{load}}^{(1)}$ (Ω)	Max Drain Efficiency					
			P1dB			P3dB		
			(dBm)	(W)	η_D (%)	(dBm)	(W)	η_D (%)
920	2.22 - j5.54	3.18 - 3.03	49.6	91	69.7	50.3	107	72.8
940	2.76 - j6.09	3.53 - j3.08	49.5	89	69.6	50.2	105	72.8
960	2.82 - j6.71	3.34 - j3.56	48.8	76	68.7	49.4	87	71.3

(1) Load impedance for optimum P1dB efficiency.

Z_{source} = Impedance as measured from gate contact to ground.

Z_{load} = Impedance as measured from drain contact to ground.

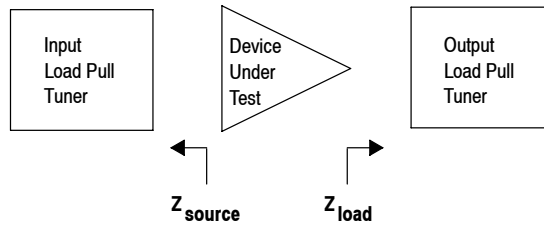
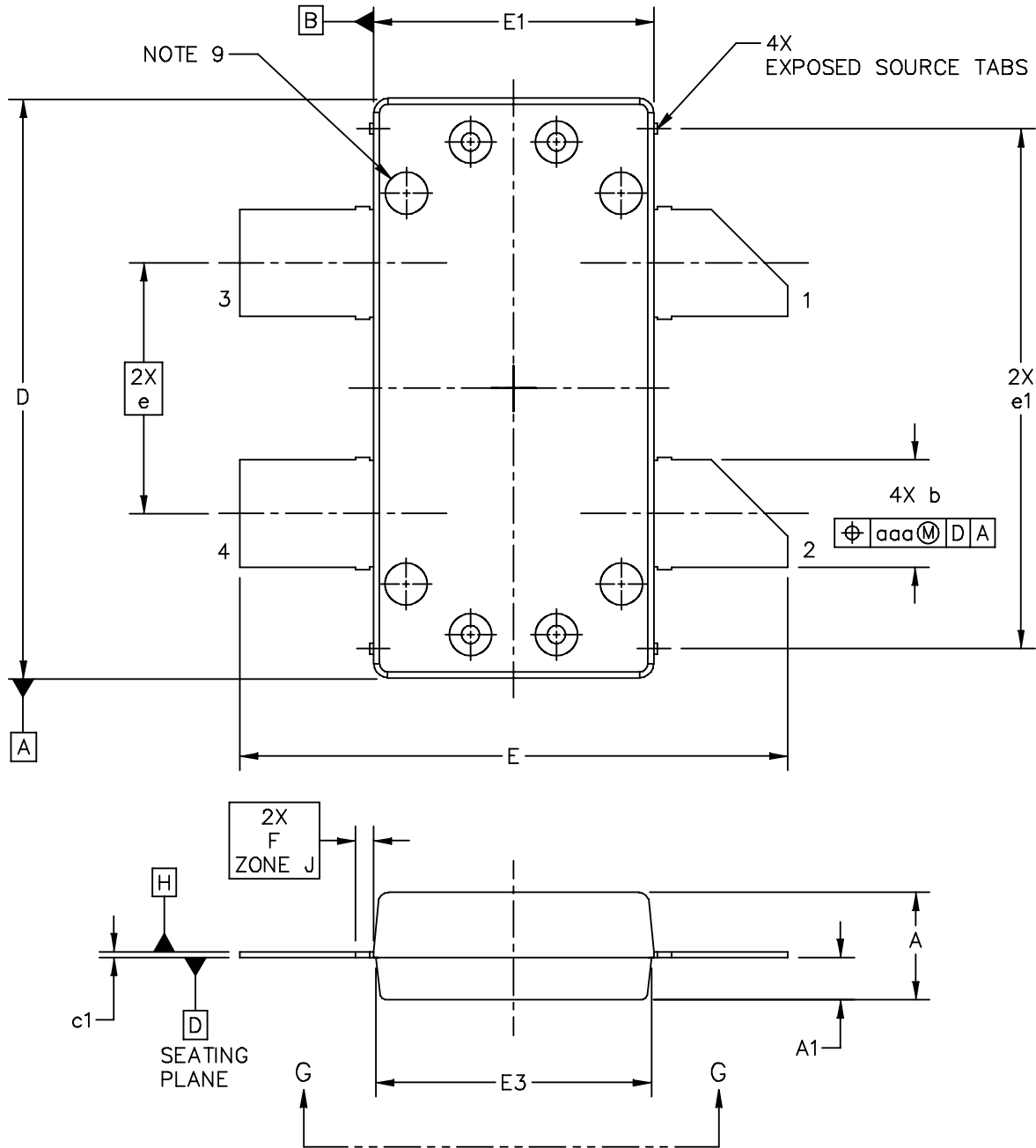
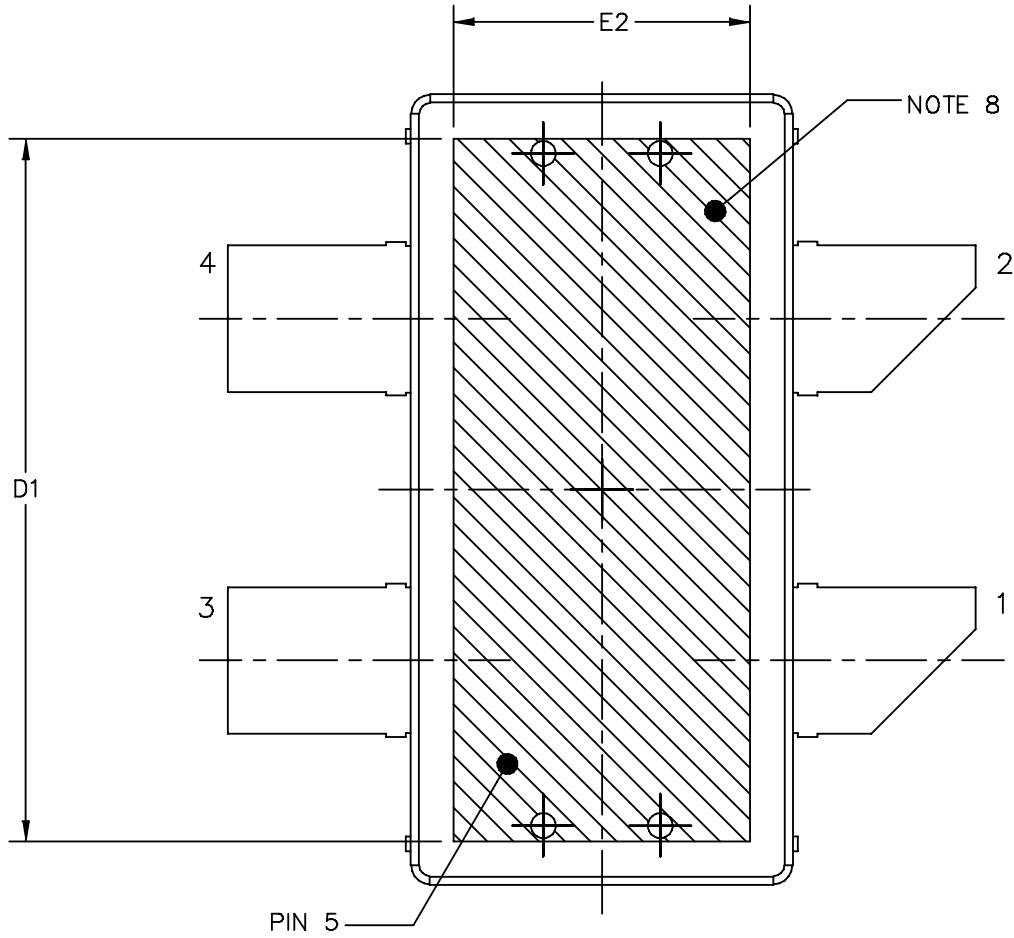

Figure 11. Carrier Side Load Pull Performance — Maximum Drain Efficiency Tuning

PACKAGE DIMENSIONS



© FREESCALE SEMICONDUCTOR, INC. ALL RIGHTS RESERVED.	MECHANICAL OUTLINE	PRINT VERSION NOT TO SCALE
TITLE: OM780-4 STRAIGHT LEAD	DOCUMENT NO: 98ASA10833D	REV: A
	CASE NUMBER: 2023-02	10 FEB 2010
	STANDARD: NON-JEDEC	



BOTTOM VIEW
VIEW G-G

© FREESCALE SEMICONDUCTOR, INC. ALL RIGHTS RESERVED.	MECHANICAL OUTLINE	PRINT VERSION NOT TO SCALE	
TITLE: OM780-4 STRAIGHT LEAD	DOCUMENT NO: 98ASA10833D	REV: A	
	CASE NUMBER: 2023-02	10 FEB 2010	
	STANDARD: NON-JEDEC		

NOTES:

1. CONTROLLING DIMENSION: INCH
2. INTERPRET DIMENSIONS AND TOLERANCES PER ASME Y14.5M-1994.
3. DATUM PLANE -H- IS LOCATED AT TOP OF LEAD AND IS COINCIDENT WITH THE LEAD WHERE THE LEAD EXITS THE PLASTIC BODY AT THE TOP OF THE PARTING LINE.
4. DIMENSIONS "D" AND "E1" DO NOT INCLUDE MOLD PROTRUSION. ALLOWABLE PROTRUSION IS .006 PER SIDE. DIMENSIONS "D AND "E1" DO INCLUDE MOLD MISMATCH AND ARE DETERMINED AT DATUM PLANE -H-.
5. DIMENSION b DOES NOT INCLUDE DAMBAR PROTRUSION. ALLOWABLE DAMBAR PROTRUSION SHALL BE .005 TOTAL IN EXCESS OF THE b DIMENSION AT MAXIMUM MATERIAL CONDITION.
6. DATUMS -A- AND -B- TO BE DETERMINED AT DATUM PLANE -H-.
7. DIMENSION A1 APPLIES WITHIN ZONE "J" ONLY.
8. HATCHING REPRESENTS THE EXPOSED AREA OF THE HEAT SLUG. THE DIMENSIONS D1 AND E2 REPRESENT THE VALUES BETWEEN THE TWO OPPOSITE POINTS ALONG THE EDGES OF EXPOSED AREA OF HEAT SLUG.
9. DIMPLED HOLE REPRESENTS INPUT SIDE.

DIM	INCH		MILLIMETER		DIM	INCH		MILLIMETER	
	MIN	MAX	MIN	MAX		MIN	MAX	MIN	MAX
A	0.148	.152	3.76	3.86	b	.147	.153	3.73	3.89
A1	.059	.065	1.50	1.65	c1	.007	.011	0.18	0.28
D	.808	.812	20.52	20.62	e	.350 BSC		8.89 BSC	
D1	.720	----	18.29	----	e1	.721	.729	18.31	18.52
E	.762	.770	19.36	19.56	aaa	.004		0.10	
E1	.390	.394	9.91	10.01					
E2	.306	----	7.77	----					
E3	.383	.387	9.72	9.83					
F	.025 BSC		0.635 BSC						
© FREESCALE SEMICONDUCTOR, INC. ALL RIGHTS RESERVED.			MECHANICAL OUTLINE			PRINT VERSION NOT TO SCALE			
TITLE: OM780-4 STRAIGHT LEAD					DOCUMENT NO: 98ASA10833D			REV: A	
					CASE NUMBER: 2023-02			10 FEB 2010	
					STANDARD: NON-JEDEC				

PRODUCT DOCUMENTATION, SOFTWARE AND TOOLS

Refer to the following documents, software and tools to aid your design process.

Application Notes

- AN1955: Thermal Measurement Methodology of RF Power Amplifiers

Engineering Bulletins

- EB212: Using Data Sheet Impedances for RF LDMOS Devices

Software

- Electromigration MTTF Calculator
- RF High Power Model
- .s2p File

Development Tools

- Printed Circuit Boards

For Software and Tools, do a Part Number search at <http://www.freescale.com>, and select the "Part Number" link. Go to the Software & Tools tab on the part's Product Summary page to download the respective tool.

REVISION HISTORY

The following table summarizes revisions to this document.

Revision	Date	Description
0	Dec. 2011	• Initial Release of Data Sheet

How to Reach Us:

Home Page:

www.freescale.com

Web Support:

<http://www.freescale.com/support>

USA/Europe or Locations Not Listed:

Freescale Semiconductor, Inc.
Technical Information Center, EL516
2100 East Elliot Road
Tempe, Arizona 85284
1-800-521-6274 or +1-480-768-2130
www.freescale.com/support

Europe, Middle East, and Africa:

Freescale Halbleiter Deutschland GmbH
Technical Information Center
Schatzbogen 7
81829 Muenchen, Germany
+44 1296 380 456 (English)
+46 8 52200080 (English)
+49 89 92103 559 (German)
+33 1 69 35 48 48 (French)
www.freescale.com/support

Japan:

Freescale Semiconductor Japan Ltd.
Headquarters
ARCO Tower 15F
1-8-1, Shimo-Meguro, Meguro-ku,
Tokyo 153-0064
Japan
0120 191014 or +81 3 5437 9125
support.japan@freescale.com

Asia/Pacific:

Freescale Semiconductor China Ltd.
Exchange Building 23F
No. 118 Jianguo Road
Chaoyang District
Beijing 100022
China
+86 10 5879 8000
support.asia@freescale.com

For Literature Requests Only:

Freescale Semiconductor Literature Distribution Center
1-800-441-2447 or +1-303-675-2140
Fax: +1-303-675-2150
LDCForFreescaleSemiconductor@hibbertgroup.com

Information in this document is provided solely to enable system and software implementers to use Freescale Semiconductor products. There are no express or implied copyright licenses granted hereunder to design or fabricate any integrated circuits or integrated circuits based on the information in this document.

Freescale Semiconductor reserves the right to make changes without further notice to any products herein. Freescale Semiconductor makes no warranty, representation or guarantee regarding the suitability of its products for any particular purpose, nor does Freescale Semiconductor assume any liability arising out of the application or use of any product or circuit, and specifically disclaims any and all liability, including without limitation consequential or incidental damages. "Typical" parameters that may be provided in Freescale Semiconductor data sheets and/or specifications can and do vary in different applications and actual performance may vary over time. All operating parameters, including "Typicals", must be validated for each customer application by customer's technical experts. Freescale Semiconductor does not convey any license under its patent rights nor the rights of others. Freescale Semiconductor products are not designed, intended, or authorized for use as components in systems intended for surgical implant into the body, or other applications intended to support or sustain life, or for any other application in which the failure of the Freescale Semiconductor product could create a situation where personal injury or death may occur. Should Buyer purchase or use Freescale Semiconductor products for any such unintended or unauthorized application, Buyer shall indemnify and hold Freescale Semiconductor and its officers, employees, subsidiaries, affiliates, and distributors harmless against all claims, costs, damages, and expenses, and reasonable attorney fees arising out of, directly or indirectly, any claim of personal injury or death associated with such unintended or unauthorized use, even if such claim alleges that Freescale Semiconductor was negligent regarding the design or manufacture of the part.

Freescale™ and the Freescale logo are trademarks of Freescale Semiconductor, Inc. All other product or service names are the property of their respective owners.

© Freescale Semiconductor, Inc. 2011. All rights reserved.