

Excellent Integrated System Limited

Stocking Distributor

Click to view price, real time Inventory, Delivery & Lifecycle Information:

[Phoenix Contact](#)
[1403974](#)

For any questions, you can email us directly:

sales@integrated-circuit.com

<https://www.phoenixcontact.com/us/produkte/1403974>



Sensor/Actuator cable - SAC-4P-M12MS/1,5-600/M12FR HD - 1403974

Please be informed that the data shown in this PDF Document is generated from our Online Catalog. Please find the complete data in the user's documentation. Our General Terms of Use for Downloads are valid (<http://download.phoenixcontact.com>)



Sensor/Actuator cable, 4-position, PP-EPDM halogen-free, Gray RAL 7035, Plug straight M12, A-coded, on Socket angled M12, A-coded, Cable length: 1.5 m, Hygienic design, With high-grade steel knurl



Key commercial data

Packing unit	0
Minimum order quantity	1
GTIN	 4 046356 677301
Custom tariff number	85444290
Country of origin	POLAND

Technical data

General data

Rated current at 40°C	4 A
Rated voltage	250 V
Number of positions	4
Volume resistance	≤ 5 mΩ
Insulation resistance	≥ 100 MΩ
Length of cable	1.5 m
Ambient temperature (operation)	-40 °C ... 105 °C (Male connector / female connector)

General characteristics

Standards/regulations	M12 plug-in connector IEC 61076-2-101
Coding	A - standard
Surge voltage category	II
Pollution degree	3
Degree of protection	IP65/IP68/IP69K
Insertion/withdrawal cycles	≥ 100
Torque	0.4 Nm (M12 plug-in connector)
Contact material	CuSn

<https://www.phoenixcontact.com/us/produkte/1403974>

Sensor/Actuator cable - SAC-4P-M12MS/1,5-600/M12FR HD - 1403974

Technical data

General characteristics

Contact surface material	Ni/Au
Contact carrier material	PP
Material of grip body	PP
Material, knurls	High-grade steel
Sealing material	FKM
Status display	No

Conductor data

Cable type	Halogen-free PP gray
Cable type (abbreviation)	600
Cable abbreviation	Li9Y9Y
Conductor cross section	4x 0.34 mm ² (signal line)
AWG signal line	22
Conductor structure signal line	42x 0.10 mm
Core diameter including insulation	1.27 mm ±0.02 mm (signal line)
Thickness, insulation	≥ 0.21 mm (Core insulation)
Wire colors	brown, white, blue, black
Overall twist	4 wires, twisted
Length of twist, overall twist	48 mm
External sheath, color	Gray RAL 7035
Outer sheath thickness	Approx. 0.8 mm
External cable diameter D	4.7 mm ±0.15 mm
Minimum bending radius, fixed installation	5 x D
Minimum bending radius, flexible installation	10 x D
Cable weight	30 kg/km
Outer sheath, material	PP-EPDM
Material conductor insulation	PP
Conductor material	Bare Cu litz wires
Conductor resistance	58 Ω/km (At an ambient temperature of 20°C)
Nominal voltage, conductor	≤ 300 V AC
Test voltage, conductor	≥ 3000 V AC (Spark test)
Special properties	FDA compliant
Halogen-free	in accordance with DIN VDE 0472 part 815
Ambient temperature (operation)	-40 °C ... 105 °C (cable, fixed installation)

Classifications

ETIM

ETIM 3.0	EC001855
ETIM 4.0	EC001855
ETIM 5.0	EC001855

<https://www.phoenixcontact.com/us/produkte/1403974>



Sensor/Actuator cable - SAC-4P-M12MS/1,5-600/M12FR HD - 1403974

Classifications

UNSPSC

UNSPSC 11	31251501
UNSPSC 12.01	31251501
UNSPSC 13.2	31251501
UNSPSC 6.01	31251501
UNSPSC 7.0901	31251501

eCl@ss

eCl@ss 4.0	27060306
eCl@ss 4.1	27060306
eCl@ss 5.0	27061801
eCl@ss 5.1	27061801
eCl@ss 6.0	27061801
eCl@ss 7.0	27061801

Accessories

Accessories

Tools

Torque screwdriver - TSD 04 SAC - 1208429



Torque screwdriver, with preset torque of 0.4 Nm and 4 mm hexagonal drive for M12 connectors

Torque screwdriver - TSD-M 1,2NM - 1212224



Torque screw driver, accuracy as per EN ISO 6789 standard, adjustable from 0.3 - 1.2 Nm

Adapter insert - TSD-M SAC-BIT ADAPTER - 1212600



Adapter bit for TSD-M...torque tools, E6.3-1/4" drive with 4 mm hexagon to accommodate SAC bits

<https://www.phoenixcontact.com/us/produkte/1403974>



Sensor/Actuator cable - SAC-4P-M12MS/1,5-600/M12FR HD - 1403974

Accessories

Adapter - SAC BIT M12-W14 - 1212513



SAC nut, for assembling M12 connectors with hexagonal high-grade steel knurl, with 4 mm hexagonal drive

Drawings

Schematic diagram

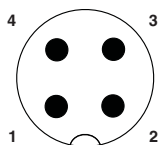

Pin assignment M12 plug, 4-pos., A-coded, view plug side

Schematic diagram

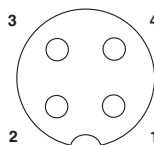

Pin assignment M12 socket, 4-pos., A-coded, view female side

Cable cross section

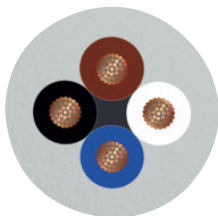

Halogen-free PP gray [600]

Circuit diagram

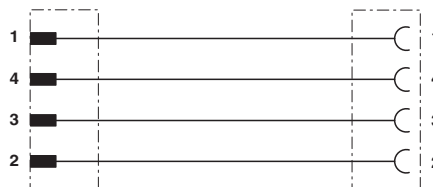

Contact assignment of the M12 plug and the M12 socket

<https://www.phoenixcontact.com/us/produkte/1403974>



Sensor/Actuator cable - SAC-4P-M12MS/1,5-600/M12FR HD - 1403974

Dimensioned drawing

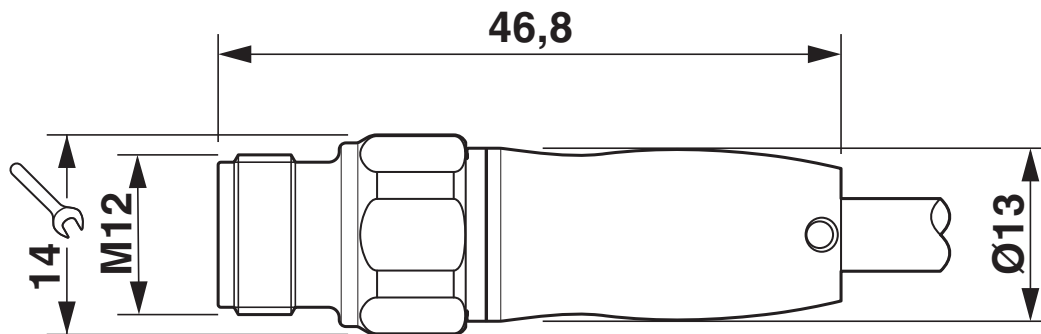

<https://www.phoenixcontact.com/us/produkte/1403974>



Sensor/Actuator cable - SAC-4P-M12MS/1,5-600/M12FR HD - 1403974

Dimensioned drawing

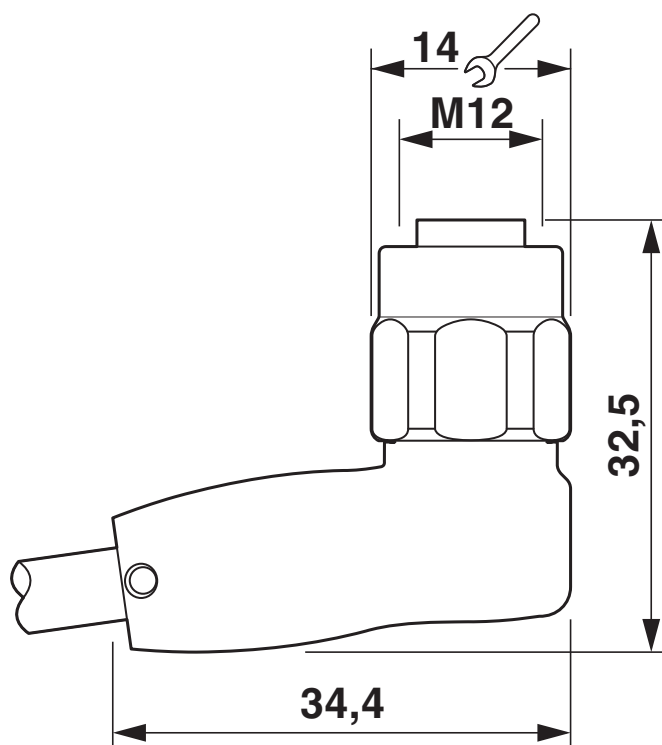

<https://www.phoenixcontact.com/us/produkte/1403974>



© Phoenix Contact 2012 - all rights reserved
<http://www.phoenixcontact.com>