

Excellent Integrated System Limited

Stocking Distributor

Click to view price, real time Inventory, Delivery & Lifecycle Information:

[Sanken](#)
[2SC4300](#)

For any questions, you can email us directly:

sales@integrated-circuit.com

2SC4300

Silicon NPN Triple Diffused Planar Transistor (High Voltage Switching Transistor)

Application : Switching Regulator and General Purpose

■ Absolute maximum ratings (Ta=25°C)

Symbol	Ratings	Unit
V _{CB0}	900	V
V _{CEO}	800	V
V _{EB0}	7	V
I _C	5(Pulse10)	A
I _B	2.5	A
P _C	75(T _C =25°C)	W
T _J	150	°C
T _{stg}	-55 to +150	°C

■ Electrical Characteristics (Ta=25°C)

Symbol	Conditions	Ratings	Unit
I _{CB0}	V _{CB} =800V	100max	μA
I _{EB0}	V _{EB} =7V	100max	μA
V _{(BR)CEO}	I _C =10mA	800min	V
h _{FE}	V _{CE} =4V, I _C =2A	10 to 30	
V _{CE(sat)}	I _C =2A, I _B =0.4A	0.5max	V
V _{BE(sat)}	I _C =2A, I _B =0.4A	1.2max	V
f _T	V _{CE} =12V, I _E =-0.5A	6typ	MHz
C _{OB}	V _{CB} =10V, f=1MHz	75typ	pF

External Dimensions FM100(TO3PF)

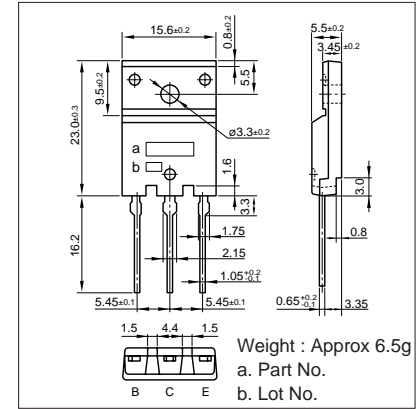

■ Typical Switching Characteristics (Common Emitter)

V _{CC} (V)	R _L (Ω)	I _C (A)	V _{BB1} (V)	V _{BB2} (V)	I _{B1} (A)	I _{B2} (A)	t _{on} (μs)	t _{stg} (μs)	t _f (μs)
250	125	2	10	-5	0.3	-1	1max	5max	1max

I_C-V_{CE} Characteristics (Typical)

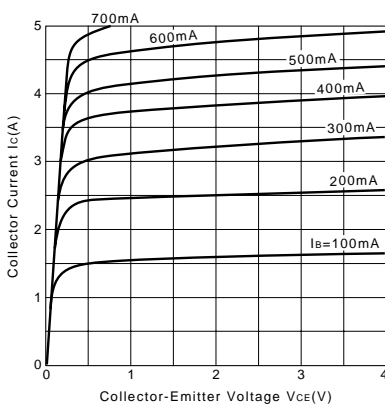

V_{CE(sat)}, V_{BE(sat)}-I_C Temperature Characteristics (Typical)

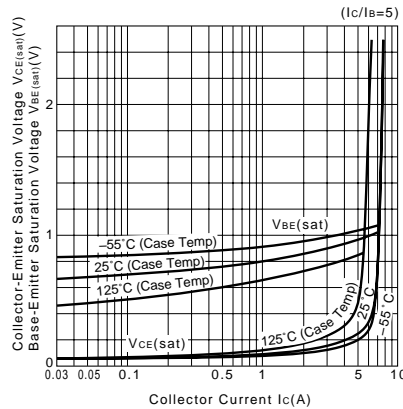

I_C-V_{BE} Temperature Characteristics (Typical)

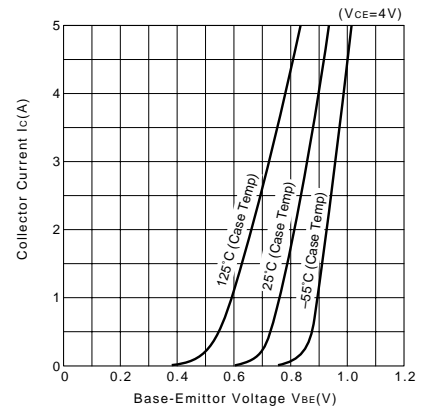

h_{FE}-I_C Characteristics (Typical)

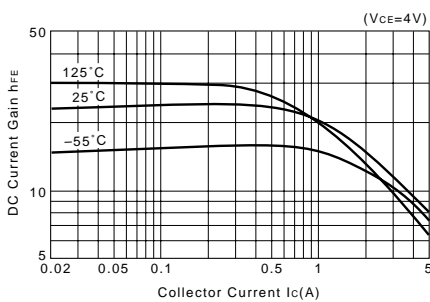

t_{on}•t_{stg}•t_f-I_C Characteristics (Typical)

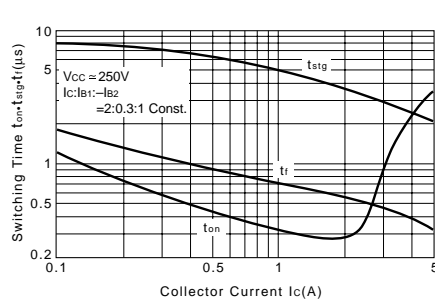

θ_{j-a}-t Characteristics

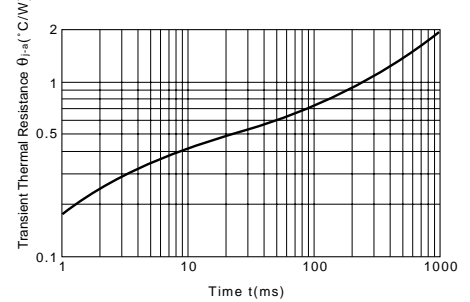

Safe Operating Area (Single Pulse)

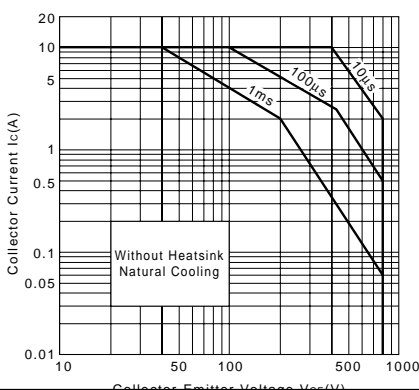

Reverse Bias Safe Operating Area

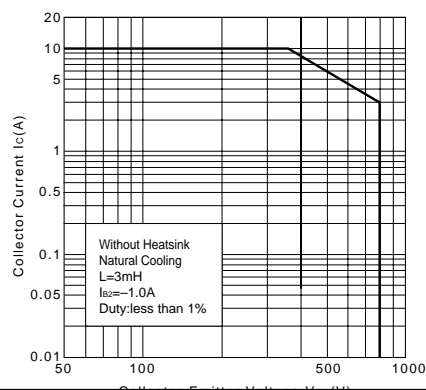

P_C-T_a Derating

