

Excellent Integrated System Limited

Stocking Distributor

Click to view price, real time Inventory, Delivery & Lifecycle Information:

[Sanken](#)
[2SC3851A](#)

For any questions, you can email us directly:

sales@integrated-circuit.com

2SC3851/3851A

Silicon NPN Epitaxial Planar Transistor (Complement to type 2SA1488/A)

Application : Audio and PPC High Voltage Power Supply, and General Purpose

Absolute maximum ratings (Ta=25°C)

Symbol	Ratings		Unit
	2SC3851	2SC3851A	
V _{CB0}	80	100	V
V _{CE0}	60	80	V
V _{EBO}	6		V
I _C	4		A
I _B	1		A
P _C	25(T _C =25°C)		W
T _j	150		°C
T _{stg}	-55 to +150		°C

Electrical Characteristics

Symbol	Conditions	Ratings		Unit
		2SC3851	2SC3851A	
I _{CBO}	V _{CB} =	80	100	μA
I _{EBO}	V _{EB} =6V	100max		μA
V _{(BR)CEO}	I _C =25mA	60min	80min	V
h _{FE}	V _{CE} =4V, I _C =1A	40 to 320		
V _{CE(sat)}	I _C =2A, I _B =0.2A	0.5max		V
f _T	V _{CE} =12V, I _E =-0.2A	15typ		MHz
C _{OB}	V _{CB} =10V, f=1MHz	60typ		pF

External Dimensions FM20(TO220F)

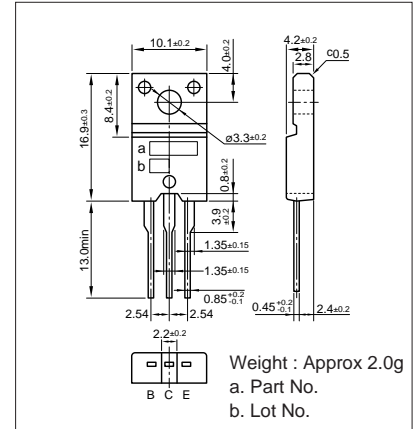

Typical Switching Characteristics (Common Emitter)

V _{CC} (V)	R _L (Ω)	I _C (A)	V _{BB1} (V)	V _{BB2} (V)	I _{B1} (mA)	I _{B2} (mA)	t _{on} (μs)	t _{stg} (μs)	t _r (μs)
12	6	2	10	-5	200	-200	0.2typ	1typ	0.3typ

I_C-V_{CE} Characteristics (Typical)

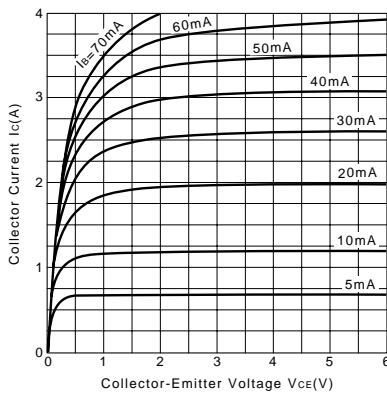

V_{CE(sat)}-I_B Characteristics (Typical)

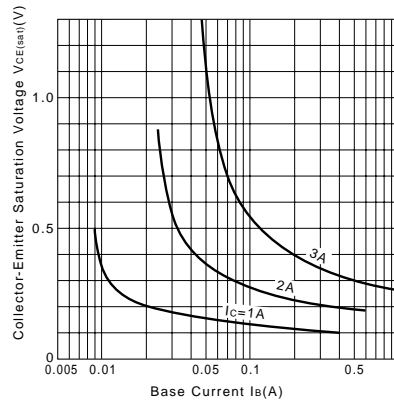

I_C-V_{BE} Temperature Characteristics (Typical)

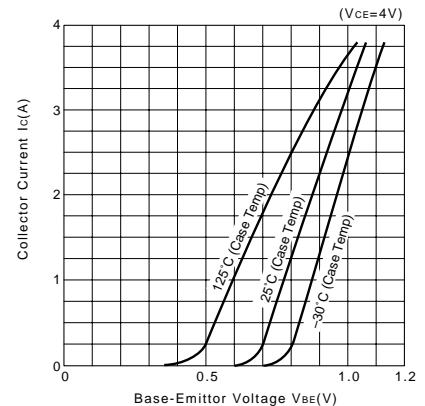

h_{FE}-I_C Characteristics (Typical)

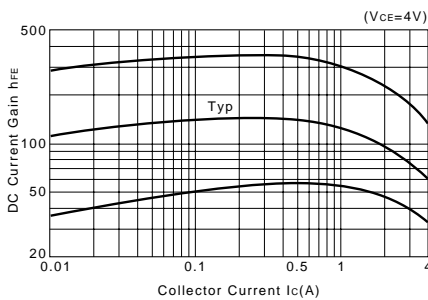

h_{FE}-I_C Temperature Characteristics (Typical)

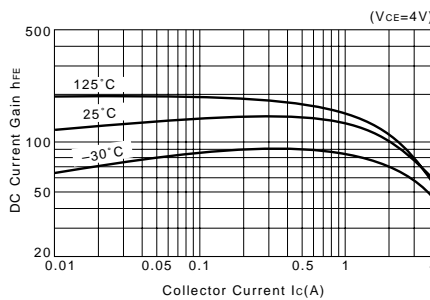

θ_{j-a}-t Characteristics

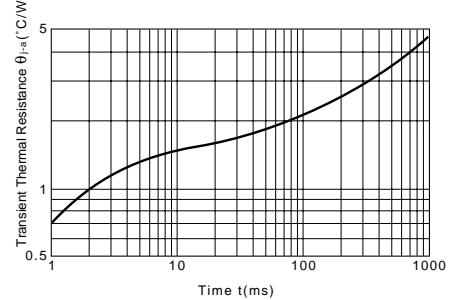

f_T-I_E Characteristics (Typical)

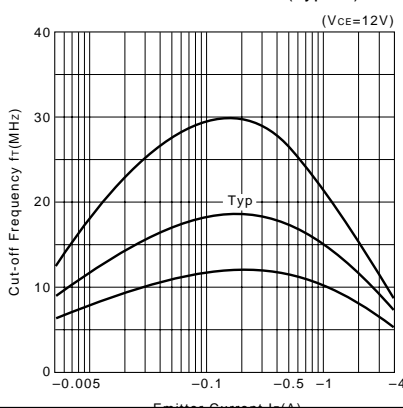

Safe Operating Area (Single Pulse)

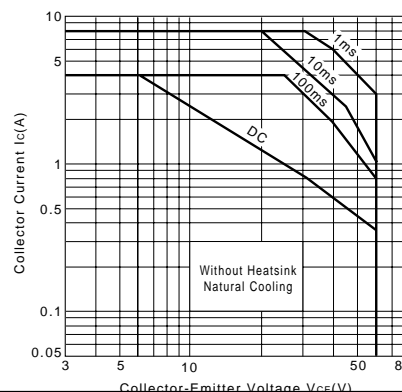

P_C-T_a Derating

