

Excellent Integrated System Limited

Stocking Distributor

Click to view price, real time Inventory, Delivery & Lifecycle Information:

[Sanken](#)
[2SA1494](#)

For any questions, you can email us directly:

sales@integrated-circuit.com

2SA1494

Silicon PNP Epitaxial Planar Transistor (Complement to type 2SC3858)

Application : Audio and General Purpose

■ Absolute maximum ratings (Ta=25°C)

Symbol	Ratings	Unit
V _{CB0}	-200	V
V _{CEO}	-200	V
V _{EB0}	-6	V
I _C	-17	A
I _B	-5	A
P _C	200(T _C =25°C)	W
T _J	150	°C
T _{stg}	-55 to +150	°C

■ Electrical Characteristics (Ta=25°C)

Symbol	Conditions	Ratings	Unit
I _{CB0}	V _{CB} =-200V	-100max	μA
I _{EB0}	V _{EB} =-6V	-100max	μA
V _{(BR)CEO}	I _C =-50mA	-200min	V
h _{FE}	V _{CE} =-4V, I _C =-8A	50min*	
V _{CE(sat)}	I _C =-10A, I _B =-1A	-2.5max	V
f _T	V _{CE} =-12V, I _E =1A	20typ	MHz
C _{OB}	V _{CB} =-10V, f=1MHz	500typ	pF

*h_{FE} Rank Y(50 to 100), P(70 to 140), G(90 to 180)

External Dimensions MT-200

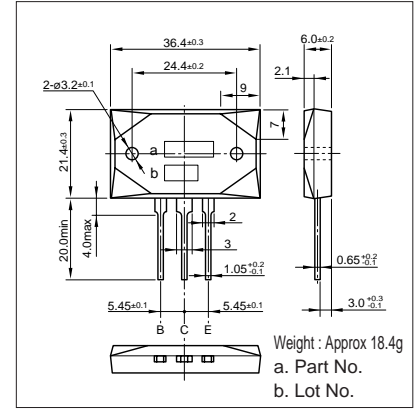

■ Typical Switching Characteristics (Common Emitter)

V _{CC} (V)	R _L (Ω)	I _C (A)	V _{BB1} (V)	V _{BB2} (V)	I _{B1} (A)	I _{B2} (A)	t _{on} (μs)	t _{stg} (μs)	t _f (μs)
-40	4	-10	-10	5	-1	1	0.6typ	0.9typ	0.2typ

I_C-V_{CE} Characteristics (Typical)

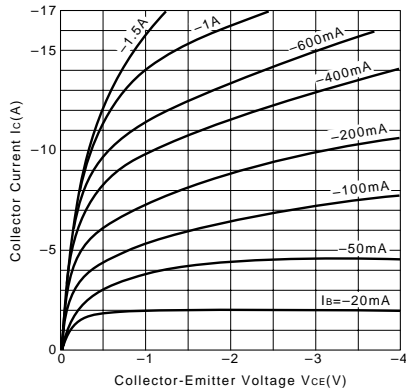

V_{CE(sat)}-I_B Characteristics (Typical)

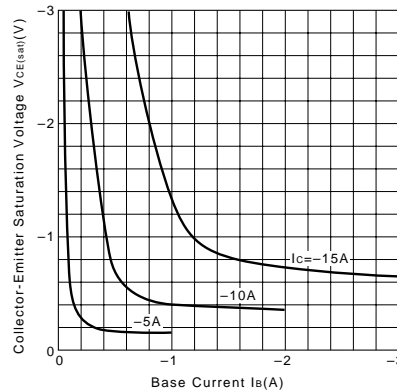

I_C-V_{BE} Temperature Characteristics (Typical)

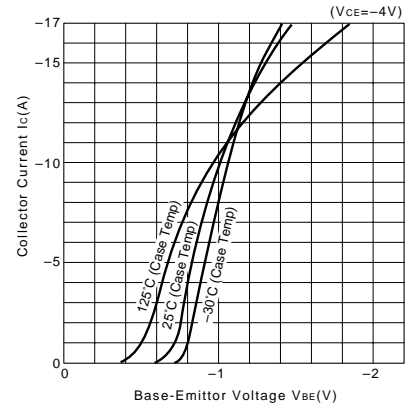

h_{FE}-I_C Characteristics (Typical)

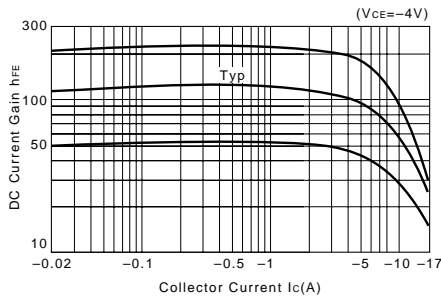

h_{FE}-I_C Temperature Characteristics (Typical)

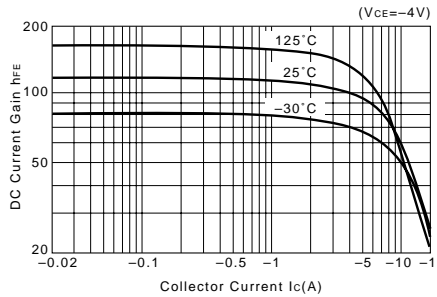

θ_{j-a}-t Characteristics

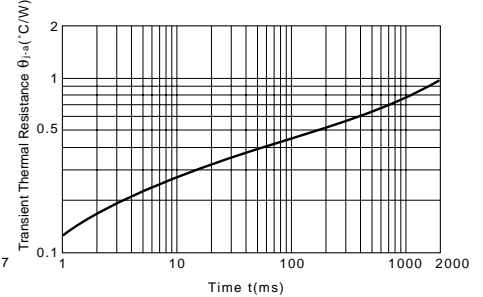

f_T-I_E Characteristics (Typical)

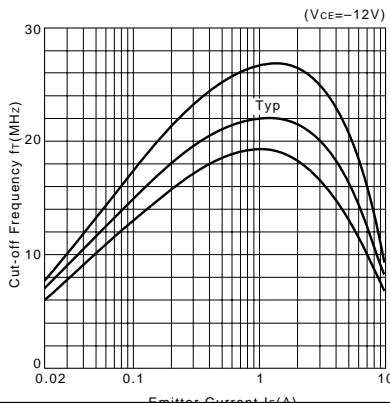

Safe Operating Area (Single Pulse)

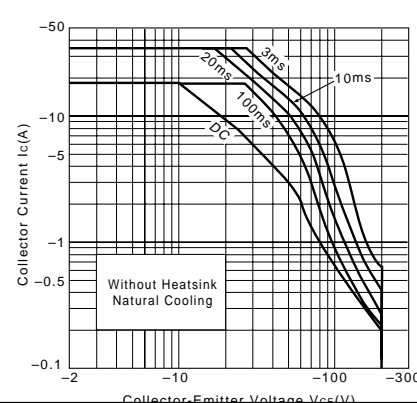

P_C-T_a Derating

