

Excellent Integrated System Limited

Stocking Distributor

Click to view price, real time Inventory, Delivery & Lifecycle Information:

[Sanken](#)
[2SC4301](#)

For any questions, you can email us directly:

sales@integrated-circuit.com

2SC4301

Silicon NPN Triple Diffused Planar Transistor (High Voltage Switching Transistor) **Application** : Switching Regulator, Lighting Inverter and General Purpose

■ **Absolute maximum ratings** (Ta=25°C)

Symbol	Ratings	Unit
V _{CB0}	900	V
V _{CE0}	800	V
V _{EBO}	7	V
I _C	7(Pulse14)	A
I _B	3.5	A
P _C	80(Tc=25°C)	W
T _J	150	°C
T _{stg}	-55 to +150	°C

■ **Electrical Characteristics** (Ta=25°C)

Symbol	Conditions	Ratings	Unit
I _{CB0}	V _{CB} =800V	100max	μA
I _{EBO}	V _{EB} =7V	100max	μA
V _{(BR)CEO}	I _C =10mA	800min	V
h _{FE}	V _{CE} =4V, I _C =3A	10to30	
V _{CE(sat)}	I _C =3A, I _B =0.6A	0.5max	V
V _{BE(sat)}	I _C =3A, I _B =0.6A	1.2max	V
f _r	V _{CE} =12V, I _E =-1A	6typ	MHZ
COB	V _{CB} =10V, f=1MHZ	105typ	pF

External Dimensions FM100(TO3PF)

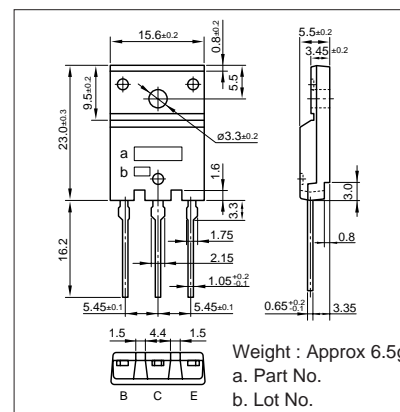

■ **Typical Switching Characteristics (Common Emitter)**

V _{CC} (V)	R _L (Ω)	I _C (A)	V _{BB1} (V)	V _{BB2} (V)	I _{B1} (A)	I _{B2} (A)	t _{on} (μs)	t _{stg} (μs)	t _f (μs)
250	83	3	10	-5	0.45	-1.5	1max	5max	1max

I_C-V_{CE} Characteristics (Typical)

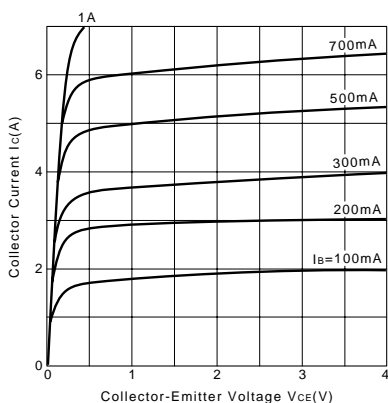

V_{CE(sat)}, V_{BE(sat)}-I_C Temperature Characteristics (Typical)

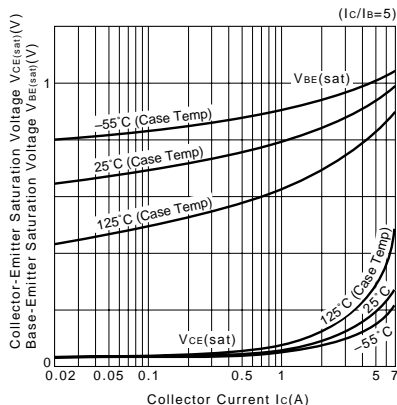

I_C-V_{BE} Temperature Characteristics (Typical)

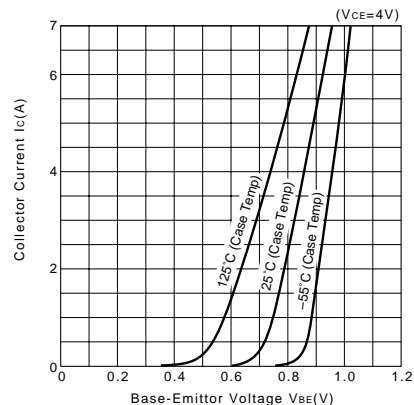

h_{FE}-I_C Characteristics (Typical)

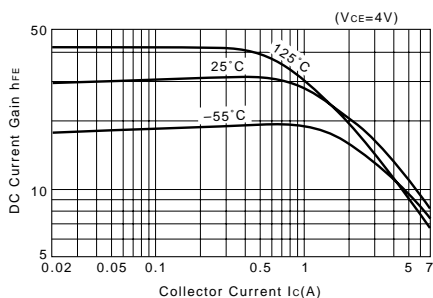

t_{on}•t_{stg}•t_f-I_C Characteristics (Typical)

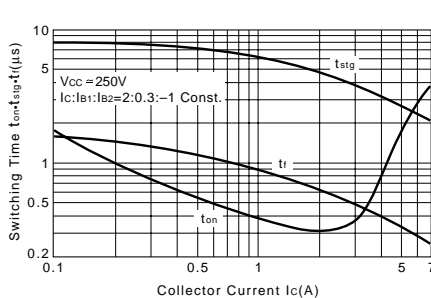

θ_{j-a}-t Characteristics

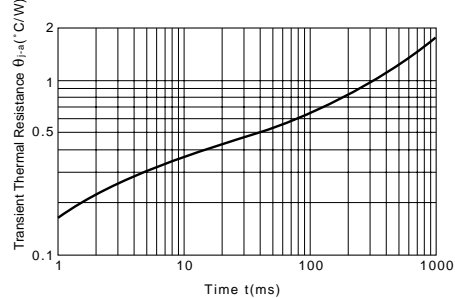

Safe Operating Area (Single Pulse)

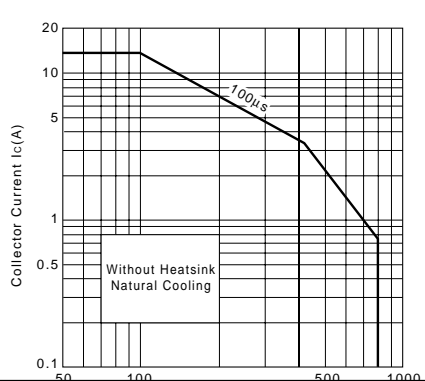

Reverse Bias Safe Operating Area

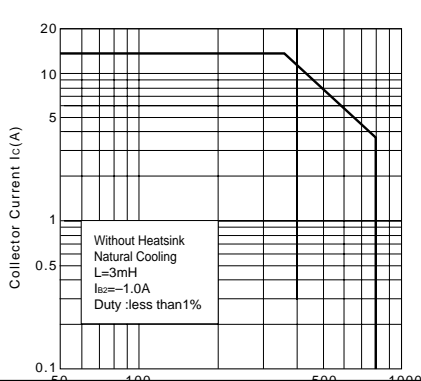

P_C-T_a Derating

