

## Excellent Integrated System Limited

Stocking Distributor

Click to view price, real time Inventory, Delivery & Lifecycle Information:

[Analog Devices Inc.](#)  
[HMC284AMS8GETR](#)

For any questions, you can email us directly:  
[sales@integrated-circuit.com](mailto:sales@integrated-circuit.com)



# Analog Devices Welcomes Hittite Microwave Corporation

NO CONTENT ON THE ATTACHED DOCUMENT HAS CHANGED

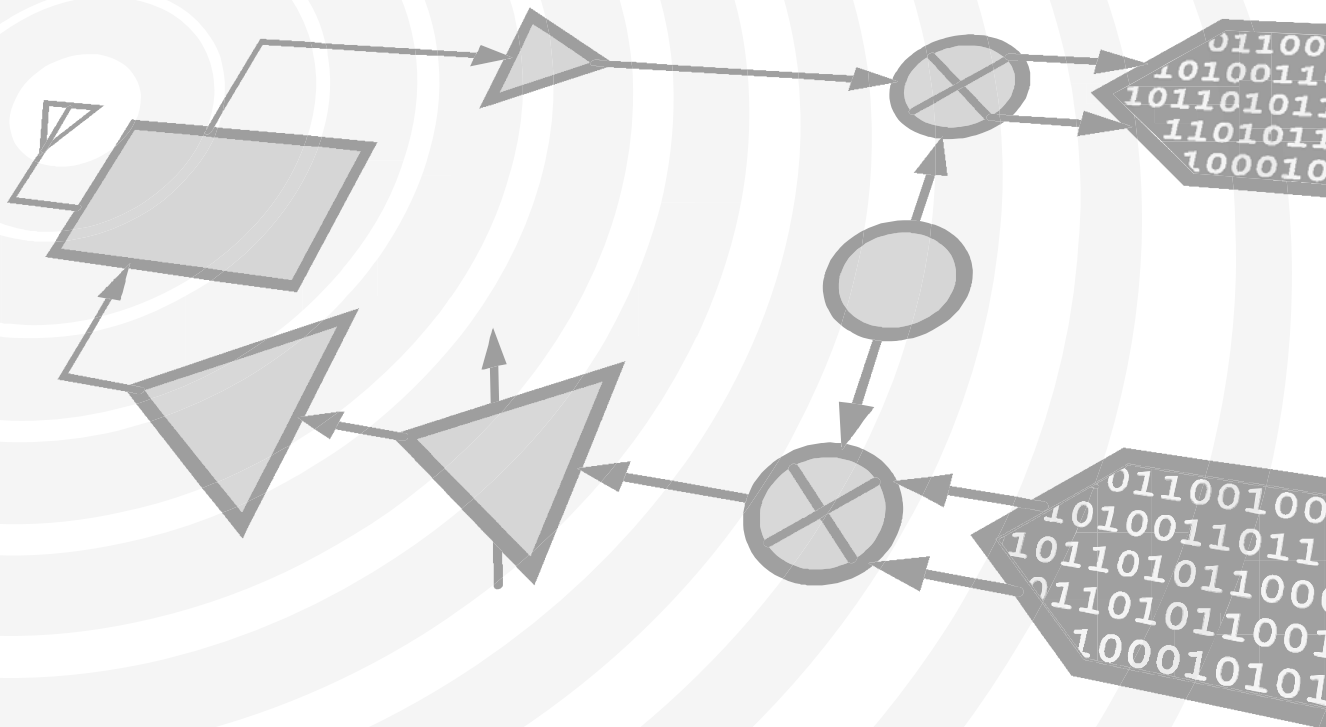

**THIS PAGE INTENTIONALLY LEFT BLANK**



# HMC284AMS8G / HMC284AMS8GE



## SPDT NON-REFLECTIVE SWITCH DC - 3.5 GHz

### Typical Applications

The HMC284AMS8G / HMC284AMS8GE is ideal for:

- Cellular/PCS Base Stations
- 2.4 GHz ISM
- 3.5 GHz Wireless Local Loop

### Features

- High Isolation: >45 dB
- Positive control: 0/+5V
- Non-Reflective Design
- Ultra Small Package: MSOP8G

### Functional Diagram

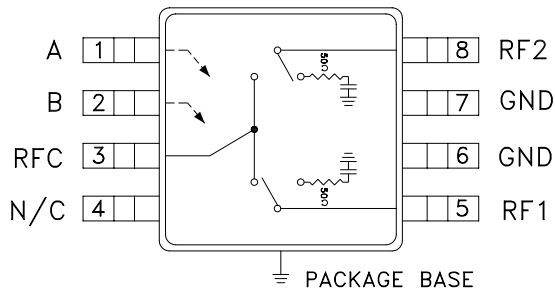

### General Description

The HMC284AMS8G & HMC284AMS8GE are low-cost SPDT switches in 8-lead grounded base MSOP packages. The design has been optimized to provide high isolation with minimal insertion loss for medium and low power applications. On-chip circuitry allows positive voltage control operation at very low DC currents with control inputs compatible with CMOS and most TTL logic families. In the "OFF" state, RF1 and RF2 are non-reflective.

### Electrical Specifications, $T_A = +25^\circ C$ , $V_{ctl} = 0/+5 V_{dc}$ , 50 Ohm System

Parameter	Frequency	Min.	Typ.	Max.	Units
Insertion Loss	DC - 2.0 GHz		0.5	0.8	dB
	DC - 3.0 GHz		0.6	0.9	dB
	DC - 3.5 GHz		0.7	1.1	dB
Isolation	RF1 & RF2	DC - 2.0 GHz	41	45	dB
	RF1 / RF2	DC - 2.5 GHz	38/41	44/45	dB
	RF1 / RF2	DC - 3.0 GHz	34/36	42/45	dB
	RF1 & RF2	DC - 3.5 GHz	30	40	dB
Return Loss (On State)	DC - 2.0 GHz	21	25		dB
	DC - 2.5 GHz	13	22		dB
	DC - 3.5 GHz	10	17		dB
Return Loss (Off State)	0.5 - 3.5 GHz	10	15		dBm
Input Power for 1 dB Compression	0.5 - 1.0 GHz	20	30		dBm
	0.5 - 3.5 GHz	18	29		dBm
Input Third Order Intercept (Two-Tone Input Power = 0 dBm Each Tone)	0.5 - 3.5 GHz	43	50		dBm
Switching Speed	DC - 3.5 GHz	tRISE, tFALL (10/90% RF)			
		tON, tOFF (50% CTL to 10/90% RF)		5	ns
			20		ns



# HMC284AMS8G / HMC284AMS8GE

MICROWAVE CORPORATION v00.0612



## SPDT NON-REFLECTIVE SWITCH DC - 3.5 GHz

**Insertion Loss**

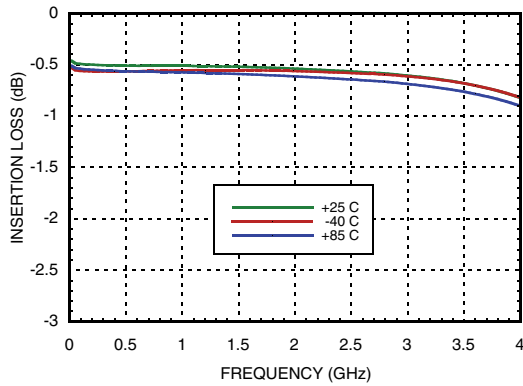

**Isolation**

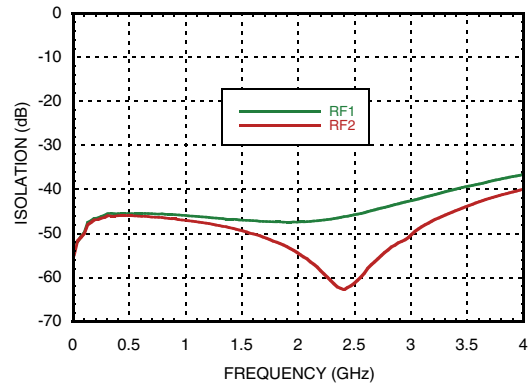

**Return Loss**

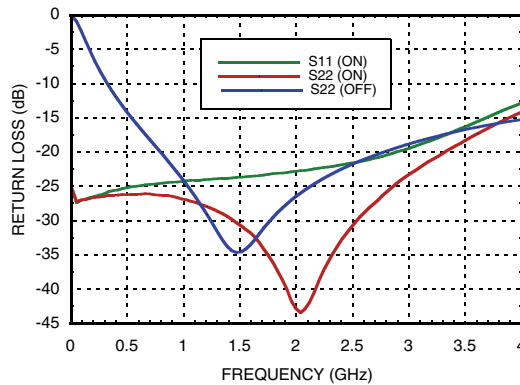



# HMC284AMS8G / HMC284AMS8GE

MICROWAVE CORPORATION v00.0612



## SPDT NON-REFLECTIVE SWITCH DC - 3.5 GHz

### Compression vs Frequency

CTL Input	Carrier at 900 MHz		Carrier at 1900 MHz	
	Input Power for 0.1 dB Compression	Input Power for 1.0 dB Compression	Input Power for 0.1 dB Compression	Input Power for 1.0 dB Compression
	(dBm)	(dBm)	(dBm)	(dBm)
+5	27	30	27	29

Caution:  
 Do not operate continuously at RF power input greater than 1 dB compression. (Vctl = 0/+5 Vdc).

### Distortion vs Frequency

Control Input	Third Order Intercept (dBm) 0 dBm Each Tone	
	900 MHz	1900 MHz
+5	50	50

### Truth Table

\*Control Input Tolerances are  $\pm 0.2$  Vdc

Control Input*		Control Current		Signal Path State	
A (Vdc)	B (Vdc)	Ia (uA)	Ib (uA)	RFC to RF1	RFC to RF2
0	+5	-0.2	0.2	ON	OFF
+5	0	0.2	-0.2	OFF	ON

DC blocks are required at ports RFC, RF1, RF2.



# HMC284AMS8G / HMC284AMS8GE

MICROWAVE CORPORATION v00.0612



## SPDT NON-REFLECTIVE SWITCH DC - 3.5 GHz

### Absolute Maximum Ratings

RF Input Power (Vctl = 0/+5V)	+26 dBm
Control Voltage Range	-0.5 to +7.5 Vdc
Hot Switch Power Level (Vctl = 0/+5V)	+18 dBm
Channel Temperature	150 °C
Thermal Resistance (Insertion Loss Path)	130 °C/W
Thermal Resistance (Terminated Path)	252 °C/W
Storage Temperature	-65 to +150 °C
Operating Temperature	-40 to +85 °C
ESD Sensitivity (HBM)	Class 1A



ELECTROSTATIC SENSITIVE DEVICE  
OBSERVE HANDLING PRECAUTIONS

### Outline Drawing

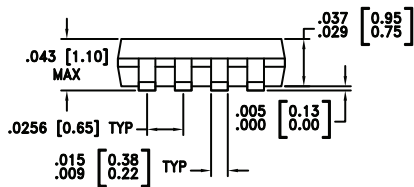
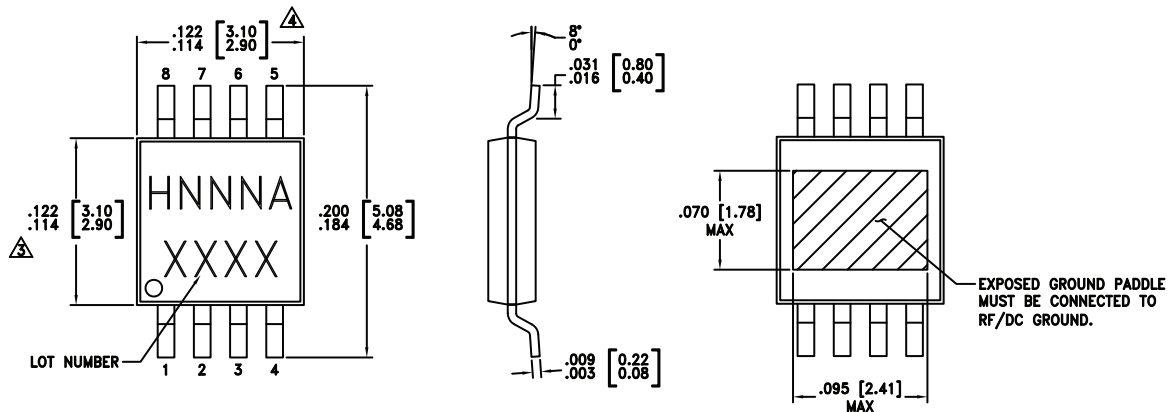

#### NOTES:

- LEADFRAME MATERIAL: COPPER ALLOY
- DIMENSIONS ARE IN INCHES [MILLIMETERS].
- $\triangle$  DIMENSION DOES NOT INCLUDE MOLDFLASH OF 0.15mm PER SIDE.
- $\triangle$  DIMENSION DOES NOT INCLUDE MOLDFLASH OF 0.25mm PER SIDE.
- ALL GROUND LEADS AND GROUND PADDLE MUST BE SOLDERED TO PCB RF GROUND.

### Package Information

Part Number	Package Body Material	Lead Finish	MSL Rating	Package Marking <sup>[3]</sup>
HMC284AMS8G	Low Stress Injection Molded Plastic	Sn/Pb Solder	MSL1 <sup>[1]</sup>	H284A XXXX
HMC284AMS8GE	RoHS-compliant Low Stress Injection Molded Plastic	100% matte Sn	MSL1 <sup>[2]</sup>	H284A XXXX

[1] Max peak reflow temperature of 235 °C

[2] Max peak reflow temperature of 260 °C

[3] 4-Digit lot number XXXX



# HMC284AMS8G / HMC284AMS8GE



## SPDT NON-REFLECTIVE SWITCH DC - 3.5 GHz

### Typical Application Circuit

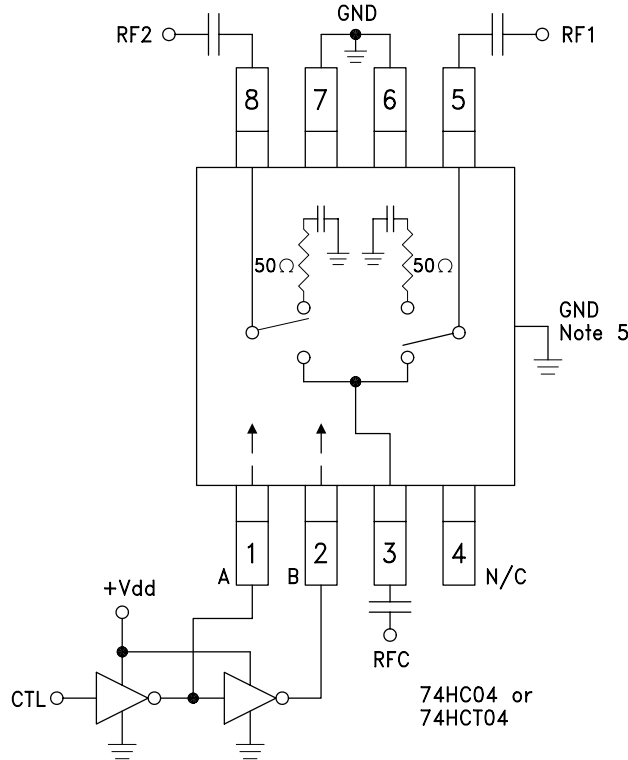

Notes:

1. Set A/B control to 0/+5V, Vdd = +5V and use HCT series logic to provide a TTL driver interface.
2. Control inputs A/B can be driven directly with CMOS logic (HC) with Vdd = +5 Volts applied to the CMOS logic gates.
3. DC blocking capacitors are required for each RF port as shown. Capacitor value determines lowest frequency of operation.
4. Highest RF signal power capability is achieved with Vdd = +7V and A/B set to 0/+7V.
5. Back side paddle must be connected to RF ground.
6. A grounded coplanar waveguide PCB layout technique is recommended to achieve high isolation. The component side ground plane between RFC/grounded paddle and RF1/RF2 should be continuous, see below. There should be a continuous ground plane under component side layout.

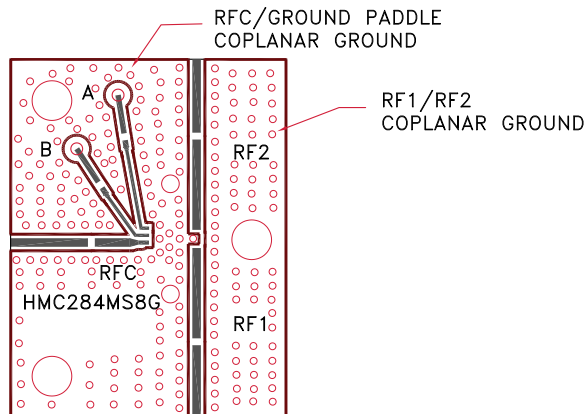





# HMC284AMS8G / HMC284AMS8GE

MICROWAVE CORPORATION v00.0612



## SPDT NON-REFLECTIVE SWITCH DC - 3.5 GHz

### Evaluation PCB

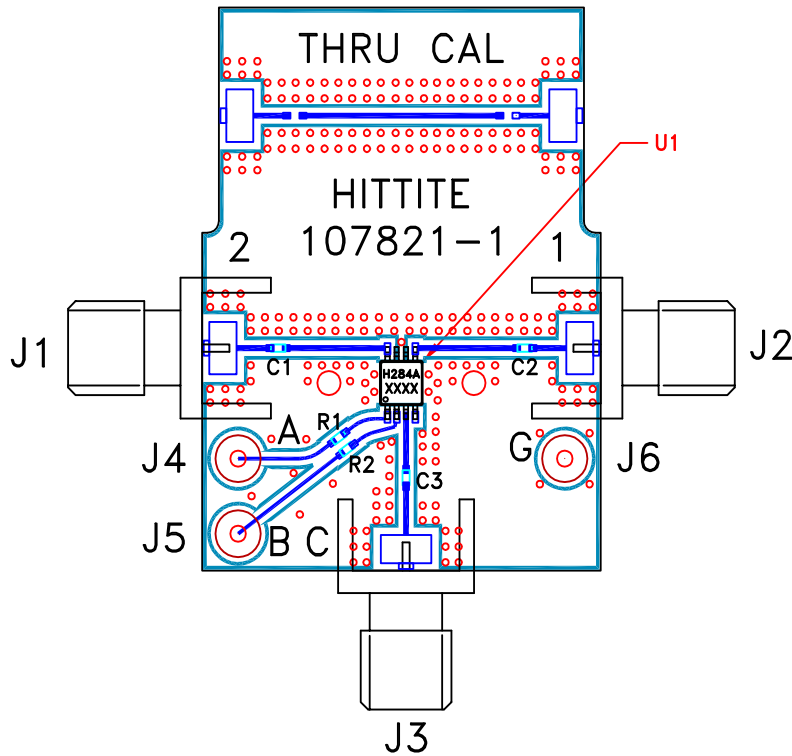

### List of Materials for Evaluation PCB 105143 [1]

Item	Description
J1 - J3	PCB Mount SMA RF Connector
J4 - J6	DC Pin
C1 - C3	100 pF capacitor, 0402 Pkg.
R1, R2	100 Ohm resistor, 0402 Pkg.
U1	HMC284AMS8G / HMC284AMS8GE SPDT Switch
PCB [2]	107821 Evaluation PCB

[1] Reference this number when ordering complete evaluation PCB

[2] Circuit Board Material: Rogers 4350

The circuit board used in the application should be generated with proper RF circuit design techniques. Signal lines at the RF port should have 50 Ohm impedance and the package ground leads and package bottom should be connected directly to the ground plane similar to that shown above. The evaluation circuit board shown above is available from Hittite Microwave Corporation upon request.