

Excellent Integrated System Limited

Stocking Distributor

Click to view price, real time Inventory, Delivery & Lifecycle Information:

[Fairchild Semiconductor](#)
[MANF260C](#)

For any questions, you can email us directly:

sales@integrated-circuit.com

FAIRCHILD
SEMICONDUCTOR™

4.0 INCH (101.6 MM)
SINGLE DIGIT STICK DISPLAY

AIGaAs RED MANF260C, MANF280C
GREEN MANF460C, MANF480C
HIGH EFF. RED MANF960C, MANF980C

PACKAGE DIMENSIONS

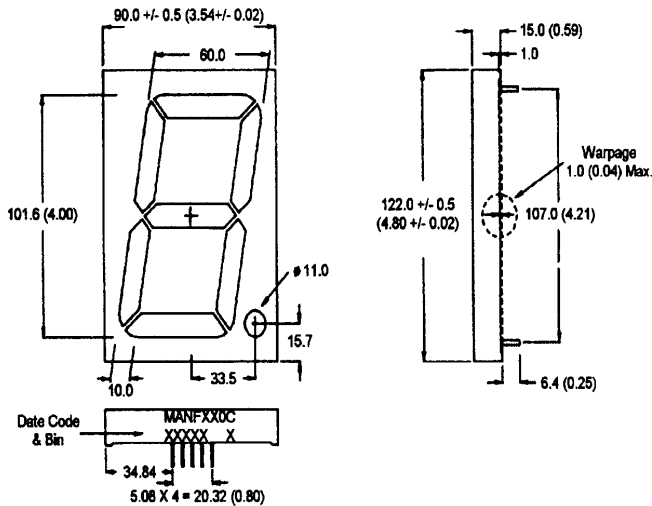

NOTES: Dimensions are in mm (inch).
All pins are 0.5 (0.02) diameter
Tolerances are ± 0.25 (0.1) unless otherwise noted.

FEATURES

- Easy to read digit
- Common anode or cathode
- Low power consumption
- Highly visible bold segments
- High brightness with high contrast
- White segments on a grey face
- Directly compatible with integrated circuits
- Rugged plastic/epoxy construction

APPLICATIONS

- Digital readout displays
- Instrument panels

MODEL NUMBERS

<u>Part number</u>	<u>Color</u>	<u>Description</u>
MANF260C	AIGaAs Red	Common Anode; right hand decimal
MANF280C	AIGaAs Red	Common Cathode; right hand decimal
MANF460C	Green	Common Anode; right hand decimal
MANF480C	Green	Common Cathode; right hand decimal
MANF960C	High efficiency red	Common Anode; right hand decimal
MANF980C	High efficiency red	Common Cathode; right hand decimal

(For other color options, contact your local area Sales Office)

FAIRCHILD
SEMICONDUCTOR™

**4.0 INCH (101.6 MM)
 SINGLE DIGIT STICK DISPLAY**

ABSOLUTE MAXIMUM RATING ($T_A=25^\circ\text{C}$ unless otherwise specified)

Part number	AlGaAs Red	Green	High Eff. Red	Unit
	MANF 260C 280C	MANF 460C 480C	MANF 960C 980C	
Continuous forward current (I_f) Per die	25	30	30	mA
Peak forward current per die (I_p) (at $f = 10.0$ KHz, Duty factor = 1/10)	200	90	90	mA
Power dissipation (P_D) per die	100*	70 *	70*	mW
*Derate linearly from 25°C	0.5	0.33	0.33	mW/ $^\circ\text{C}$
Reverse voltage per dice.....				5V
Operating and Storage temperature range.....				- 40°C to $+85^\circ\text{C}$
Lead soldering time (at 1/16 inch from the bottom of lamp).....				5 seconds @ 230°C

ELECTRO - OPTICAL CHARACTERISTICS ($T_A = 25^\circ\text{C}$ unless otherwise specified)

Part number	AlGaAs Red	Green	High Eff. Red	Test Condition
	MANF 260C 280C	MANF 460C 480C	MANF 960C 980C	
Luminous intensity (ucd) typical	9000	7900	6300	$I_f = 20$ mA
Forward voltage (V_F) typical	9.0	10.5	10.0	$I_f = 20$ mA
maximum	12.5	14.0	14.0	$I_f = 20$ mA
Peak wavelength (nm)	660	570	635	$I_f = 20$ mA
Spectral line half width (nm)	20	30	45	$I_f = 20$ mA
Reverse breakdown voltage (V_R)	10	10	10	$I_R = 100$ uA

FAIRCHILD
SEMICONDUCTOR™

**4.0 INCH (101.6 MM)
SINGLE DIGIT STICK DISPLAY**

PINOUT

MANFX60C - Common Anode

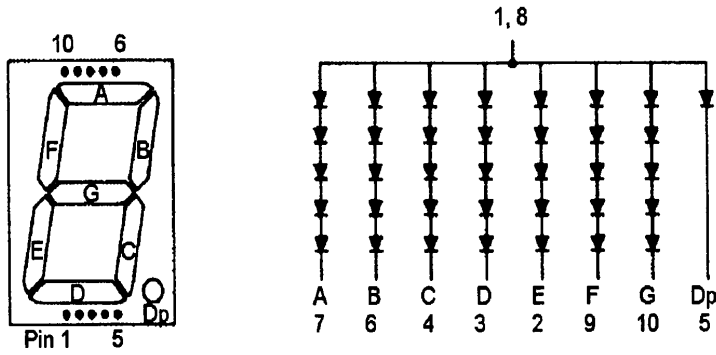

MANFX80C - Common Cathode

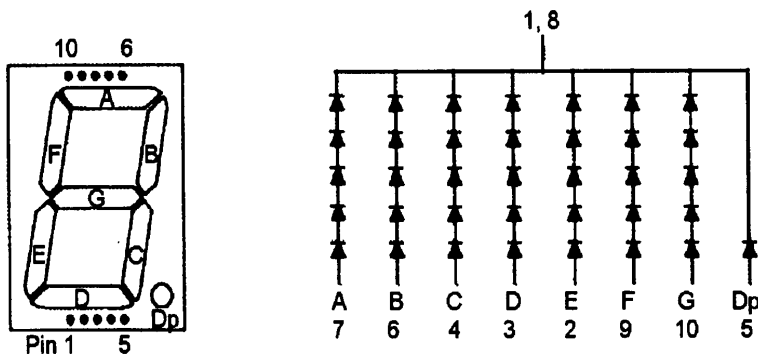

FAIRCHILD
SEMICONDUCTOR™

**4.0 INCH (101.6 MM)
SINGLE DIGIT STICK DISPLAY**

GRAPHICAL DETAIL: AlGaAs Red ($T_A = 25^\circ\text{C}$ unless otherwise specified)

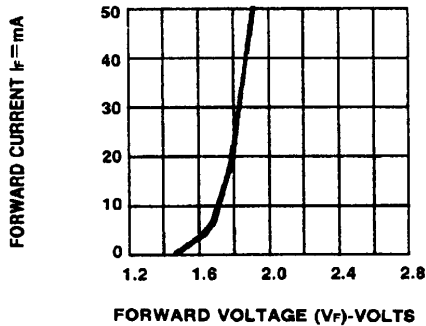

Fig.1 FORWARD CURRENT VS. FORWARD VOLTAGE.

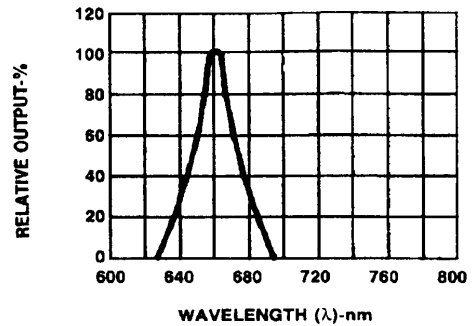

Fig.2 SPECTRAL RESPONSE

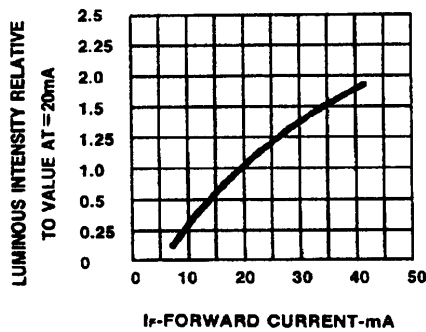

Fig.3 RELATIVE LUMINOUS INTENSITY VS. FORWARD CURRENT

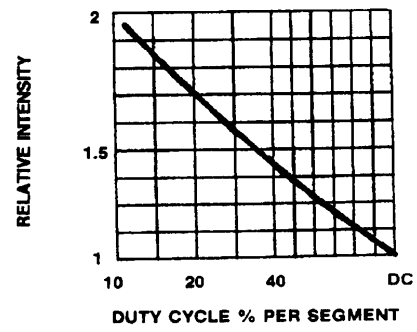

Fig.5 LUMINOUS INTENSITY VS. DUTY CYCLE

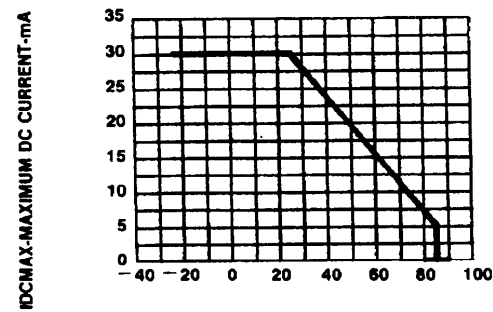

Fig.4 MAXIMUM ALLOWABLE DC CURRENT PER SEGMENT VS. A FUNCTION OF AMBIENT TEMPERATURE.

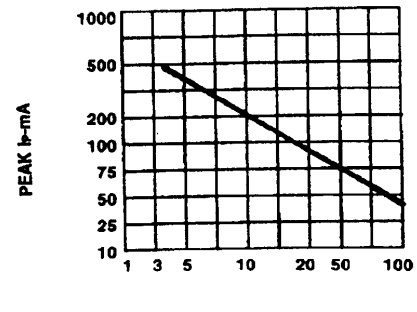

Fig. 6 MAX PEAK CURRENT VS. DUTY CYCLE % (REFRESH RATE $f = 1 \text{ KHz}$)

FAIRCHILD
SEMICONDUCTOR™

**4.0 INCH (101.6 MM)
SINGLE DIGIT STICK DISPLAY**

GRAPHICAL DETAIL: Green ($T_A = 25^\circ\text{C}$ unless otherwise specified)

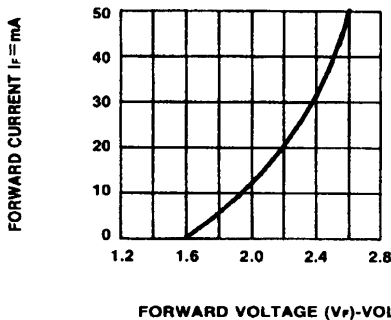

Fig.1 FORWARD CURRENT VS. FORWARD VOLTAGE.

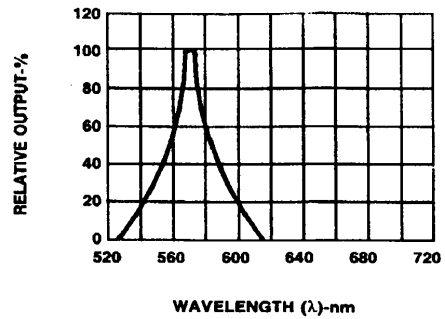

Fig.2 SPECTRAL RESPONSE

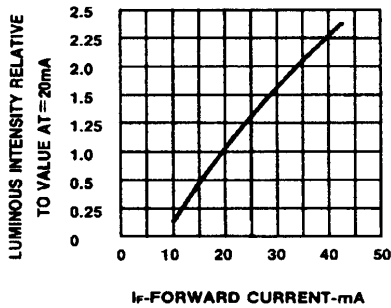

Fig.3 RELATIVE LUMINOUS INTENSITY VS. FORWARD CURRENT

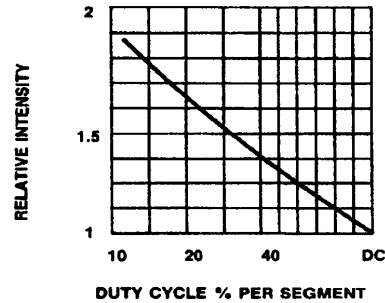

Fig.5 LUMINOUS INTENSITY VS. DUTY CYCLE

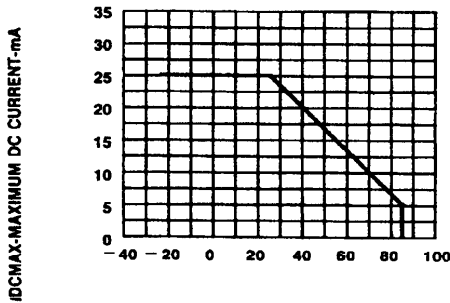

Fig.4 MAXIMUM ALLOWABLE DC CURRENT PER SEGMENT CS. A FUNCTION OF AMBIENT TEMPERATURE.

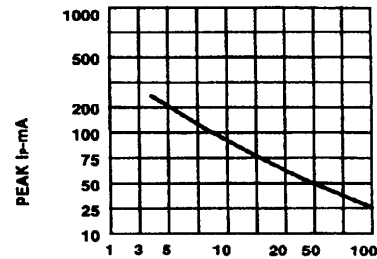

Fig.6 MAX PEAK CURRENT VS. DUTY CYCLE % (REFRESH RATE f = 1 KHz)

FAIRCHILD
SEMICONDUCTOR™

**4.0 INCH (101.6 MM)
SINGLE DIGIT STICK DISPLAY**

GRAPHICAL DETAIL: High Efficiency Red ($T_A = 25^\circ\text{C}$ unless otherwise specified)

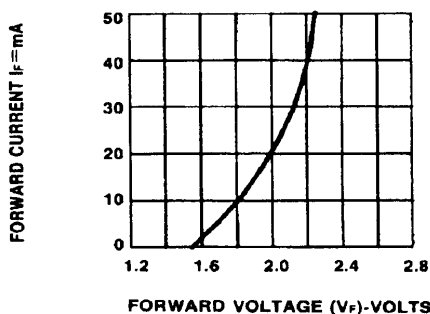

Fig.1 FORWARD CURRENT VS. FORWARD VOLTAGE.

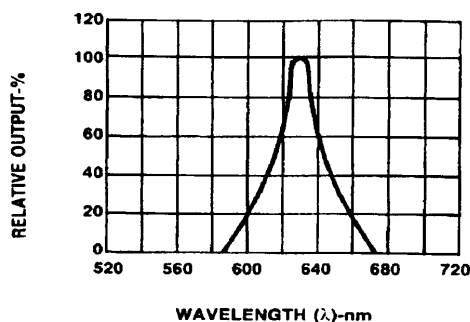

Fig.2 SPECTRAL RESPONSE

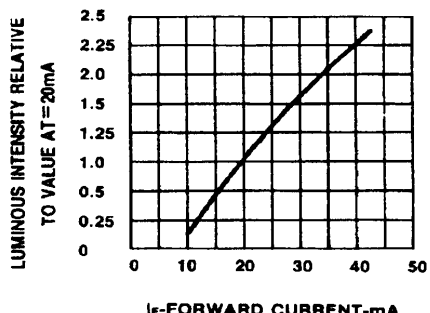

Fig.3 RELATIVE LUMINOUS INTENSITY VS. FORWARD CURRENT

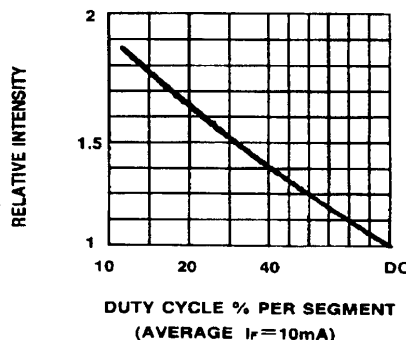

Fig.5 LUMINOUS INTENSITY VS. DUTY CYCLE

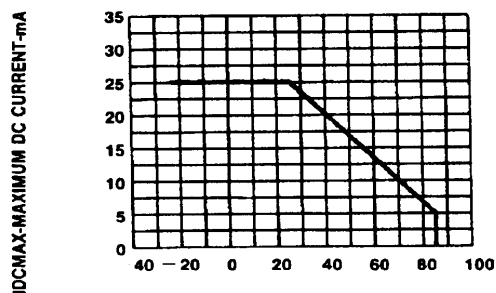

Fig.4 MAXIMUM ALLOWABLE DC CURRENT PER SEGMENT VS. A FUNCTION OF AMBIENT TEMPERATURE.

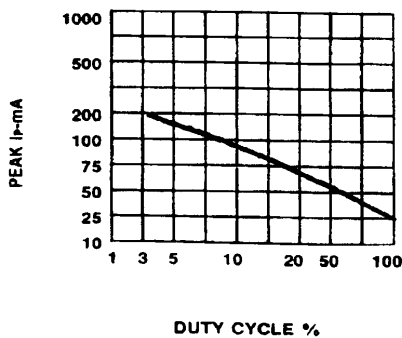

Fig.6 MAX PEAK CURRENT VS. DUTY CYCLE % (REFRESH RATE f = 1 KHz)



4.0 INCH (101.6 MM) SINGLE DIGIT STICK DISPLAY

DISCLAIMER

FAIRCHILD SEMICONDUCTOR RESERVES THE RIGHT TO MAKE CHANGES WITHOUT FURTHER NOTICE TO ANY PRODUCTS HEREIN TO IMPROVE RELIABILITY, FUNCTION OR DESIGN. FAIRCHILD DOES NOT ASSUME ANY LIABILITY ARISING OUT OF THE APPLICATION OR USE OF ANY PRODUCT OR CIRCUIT DESCRIBED HEREIN; NEITHER DOES IT CONVEY ANY LICENSE UNDER ITS PATENT RIGHTS, NOR THE RIGHTS OF OTHERS.

LIFE SUPPORT POLICY

FAIRCHILD'S PRODUCTS ARE NOT AUTHORIZED FOR USE AS CRITICAL COMPONENTS IN LIFE SUPPORT DEVICES OR SYSTEMS WITHOUT THE EXPRESS WRITTEN APPROVAL OF THE PRESIDENT OF FAIRCHILD SEMICONDUCTOR CORPORATION. As used herein:

1. Life support devices or systems are devices or systems which, (a) are intended for surgical implant into the body, or (b) support or sustain life, and (c) whose failure to perform when properly used in accordance with instructions for use provided in the labeling, can be reasonably expected to result in a significant injury of the user.
2. A critical component in any component of a life support device or system whose failure to perform can be reasonably expected to cause the failure of the life support device or system, or to affect its safety or effectiveness.