

Excellent Integrated System Limited

Stocking Distributor

Click to view price, real time Inventory, Delivery & Lifecycle Information:

[E-Switch](#)
[100DP1T6B12M2QE](#)

For any questions, you can email us directly:

sales@integrated-circuit.com

SHEET 1 OF 1

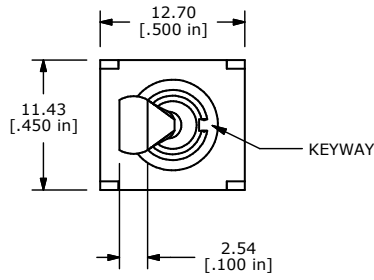
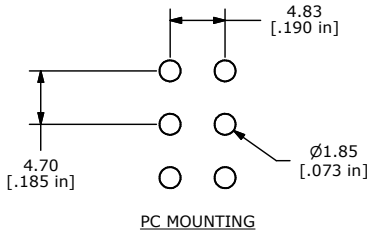

ISOMETRIC

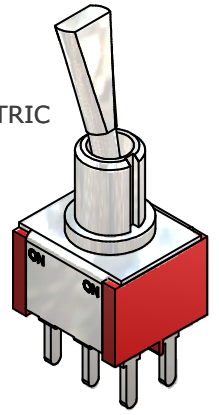

SWITCH FUNCTION		
POS. 1	POS. 2	POS. 3
ON	NONE	ON
2-3, 5-6	N/A	2-1, 5-4

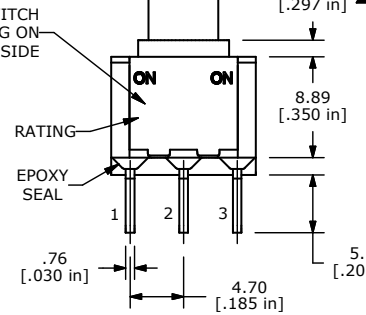
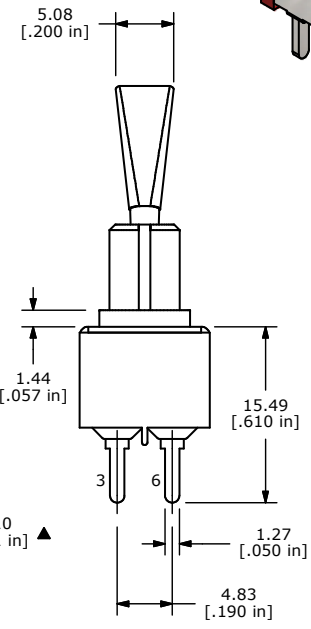
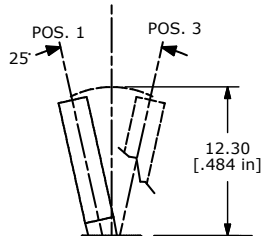
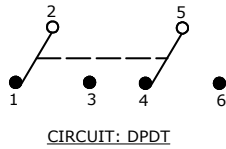

- NOTE:
1. ALL DIMENSIONS IN MM [INCH]
 2. GENERAL TOLERANCE: X.X=±0.4
X.XX=±0.25
 3. TERMINAL NUMBERS FOR REF ONLY
 - ▲ 4. PLATING MATERIAL: SILVER
 5. RATING: 5AMPS @ 120VAC OR 28VDC
2 AMPS@ 250VAC
 6. CONTACT RESISTANCE: 10 Milli-OHMS MAX.
 7. LIFE EXPECTANCY: 40,000 make-and-break cycles at full load.
 8. INSULATION RESISTANCE: 1,000 Mega-OHMS MIN.
 9. DIELECTRIC STRENGTH: 1,000 V RMS @sea level.
 10. OPERATING TEMP.: -30°C to 85°C
 11. ▲ DENOTES CRITICAL PARAMETER.
 12. 2002/95/EC (ROHS) COMPLIANT



A	18673	Released For Production	10/8/09	BLR
REV	PCR NO	DESCRIPTION	DATE	BY

TITLE 100DP1T6B12M2QE				
SCALE 2:1	DATE 10/8/2009	DR BLR	DWG T121145	REV A

THE INFORMATION CONTAINED IN THIS DOCUMENT IS PROPRIETARY TO E-SWITCH AND IS NOT TO BE COPIED OR TRANSFERRED