

Excellent Integrated System Limited

Stocking Distributor

Click to view price, real time Inventory, Delivery & Lifecycle Information:

[Fairchild Semiconductor](#)
[QTLP650C23TR](#)

For any questions, you can email us directly:

sales@integrated-circuit.com



SURFACE MOUNT LED LAMP STANDARD BRIGHT 1210

QTLP650C-23 HER/Yellow
QTLP650C-34 Yellow/Green

QTLP650C-24 HER/Green
QTLP650C-74 AlGaAs Red/Green

PACKAGE DIMENSIONS

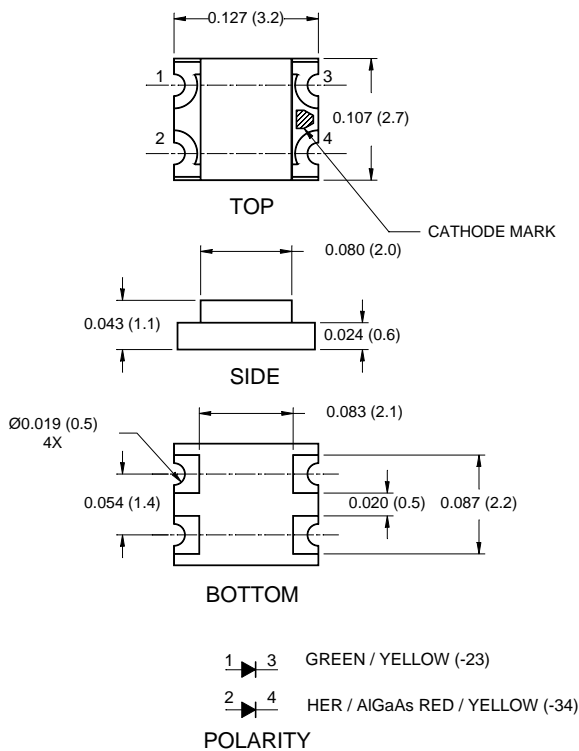

NOTE:
 Dimensions for all drawings are in inches (mm).

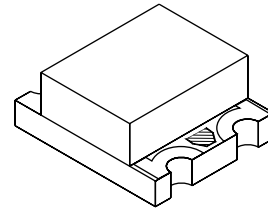

APPLICATIONS

- Keypad backlighting
- Push-button backlighting
- LCD backlighting

DESCRIPTION

These bi-color surface mount chip LEDs are designed to fit industry standard footprint. Small size, low profile and wide viewing angle make these LEDs ideal for backlighting applications and panel illumination.

FEATURES

- Miniature footprint - 3.2(L) X 2.7(W) X 1.1(H) mm
- Wide viewing angle of 140°
- Water clear optics
- Moisture-proof packaging
- Available in 0.315" (8mm) width tape on 7" (178mm) diameter reel; 2,000 units per reel



SURFACE MOUNT LED LAMP STANDARD BRIGHT 1210

QTLP650C-23 HER/Yellow
QTLP650C-34 Yellow/Green

QTLP650C-24 HER/Green
QTLP650C-74 AlGaAs Red/Green

ABSOLUTE MAXIMUM RATINGS (T_A =25°C Unless otherwise specified)

Parameter	Symbol	QTLP650C				Units
		-23	-24	-34	-74	
Continuous Forward Current	I _F	30 / 30	30 / 30	30 / 30	30 / 30	mA
Peak Forward Current (f = 1.0 KHz, Duty Factor = 1/10)	I _{FM}	160 / 160	160 / 160	160 / 160	180 / 160	mA
Reverse Voltage	V _R	5	5	5	5	V
Power Dissipation	P _D	84 / 84	84 / 84	84 / 84	72 / 84	mW
Operating Temperature	T _{OPR}	-40 to +85				°C
Storage Temperature	T _{STG}	-40 to +90				°C
Lead Soldering Time	T _{SOL}	260 for 5 sec				°C

ELECTRICAL / OPTICAL CHARACTERISTICS (T_A =25°C)

Parameter	Symbol	QTLP650C				Units
		-23	-24	-34	-74	
Luminous Intensity (mcd)	I _V	2.5 / 4.0	2.5 / 4.0	4.0 / 4.0	9.0 / 4.0	I _F = 20mA
Minimum		4.0 / 6.5	4.0 / 6.5	6.5 / 6.5	15 / 6.5	
Typical	V _F	2.8 / 2.8	2.8 / 2.8	2.8 / 2.8	2.4 / 2.8	I _F = 20mA
Forward Voltage (V)		2.0 / 2.0	2.0 / 2.0	2.0 / 2.0	1.9 / 2.0	
Maximum	I _P	635 / 585	635 / 565	585 / 565	660 / 565	I _F = 20mA
Typical		630 / 590	630 / 570	590 / 570	645 / 570	
Wavelength (nm)	D _I	45 / 35	45 / 30	35 / 30	20 / 30	I _F = 20mA
Peak		140	140	140	140	
Dominant	2U1/2	140	140	140	140	I _F = 20mA
Spectral Line Half Width (nm)		140	140	140	140	
Viewing Angle (°)						



SURFACE MOUNT LED LAMP STANDARD BRIGHT 1210

QTLP650C-23 HER/Yellow
QTLP650C-34 Yellow/Green

QTLP650C-24 HER/Green
QTLP650C-74 AlGaAs Red/Green

TYPICAL PERFORMANCE CURVES

Fig. 1 Forward Current vs. Forward Voltage

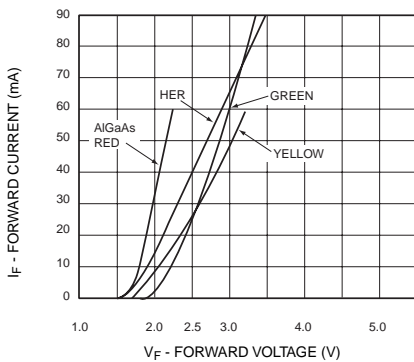

Fig. 2 Relative Luminous Intensity vs. DC Forward Current

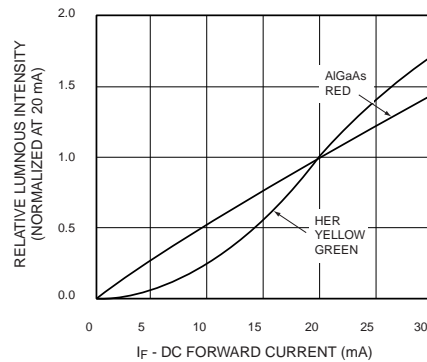

Fig. 3 Relative Intensity vs. Peak Wavelength

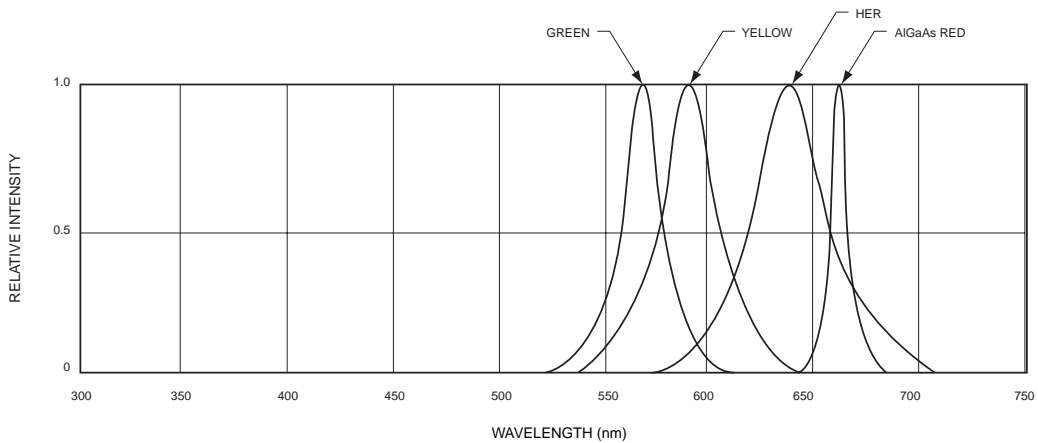

Fig.4 Radiation Diagram

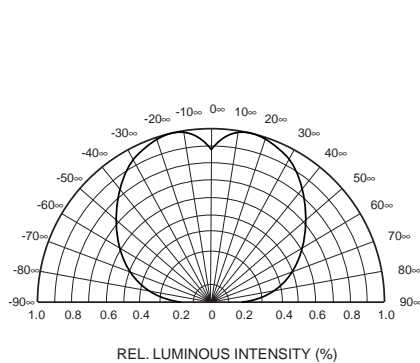
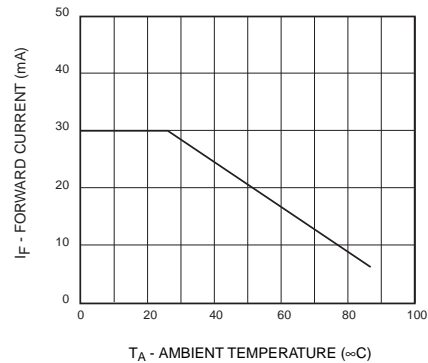

Fig.5 Maximum Forward Current vs. Ambient Temperature





SURFACE MOUNT LED LAMP STANDARD BRIGHT 1210

QTLP650C-23 HER/Yellow
QTLP650C-34 Yellow/Green

QTLP650C-24 HER/Green
QTLP650C-74 AlGaAs Red/Green

RECOMMENDED PRINTED CIRCUIT BOARD PATTERN

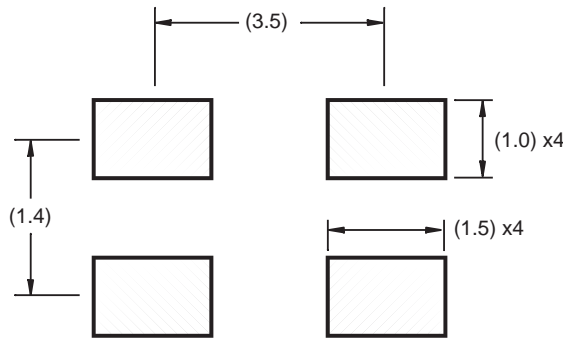

Note: All units are in mm

RECOMMENDED IR REFLOW SOLDERING PROFILE

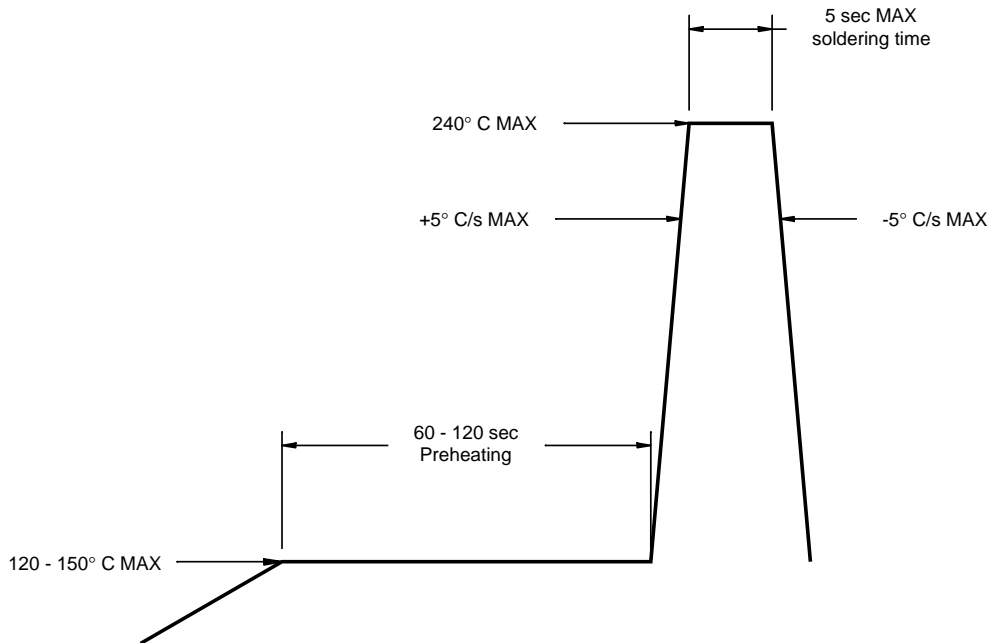



SURFACE MOUNT LED LAMP STANDARD BRIGHT 1210

QTLP650C-23 HER/Yellow
QTLP650C-34 Yellow/Green

QTLP650C-24 HER/Green
QTLP650C-74 AlGaAs Red/Green

TAPE AND REEL DIMENSIONS

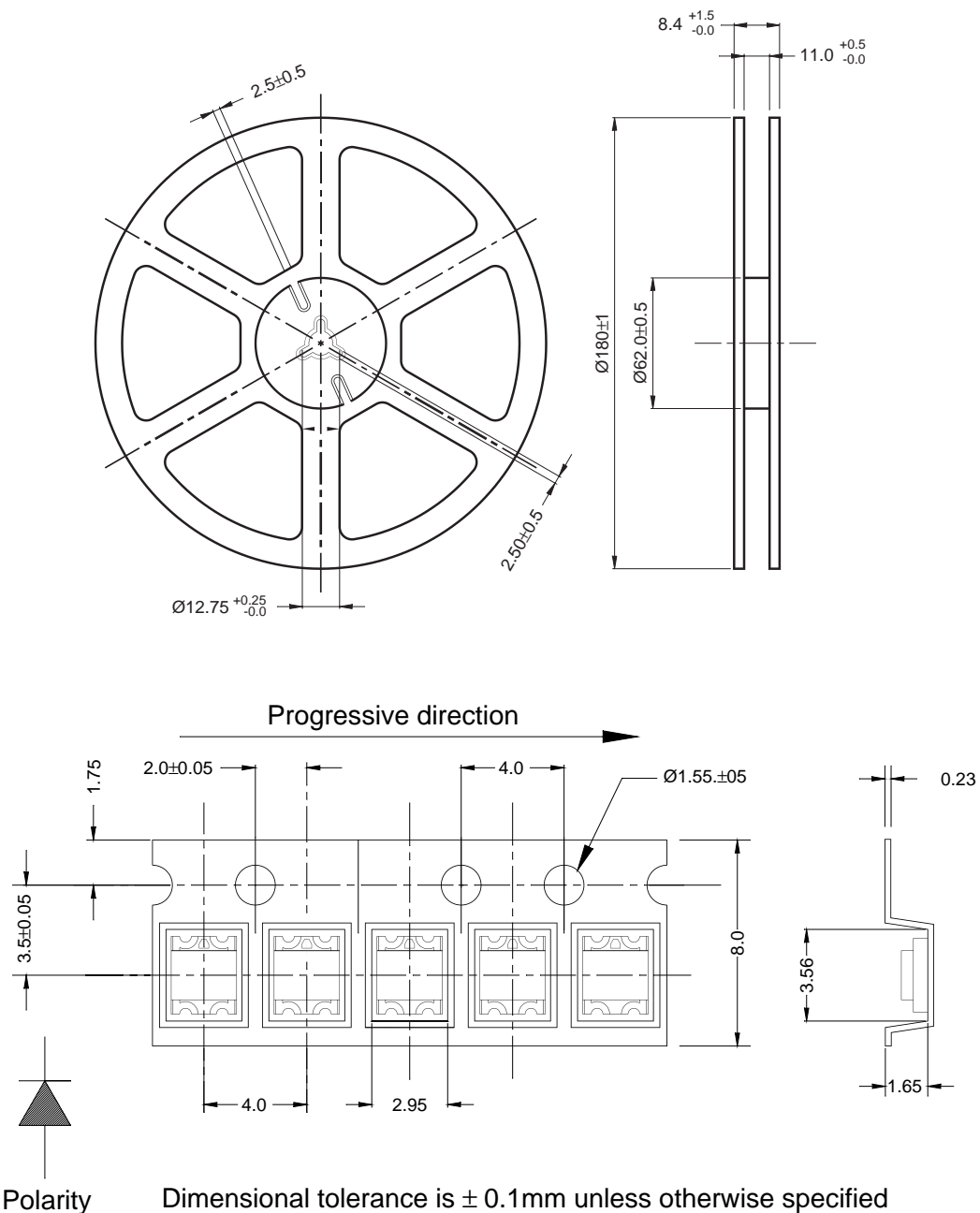

Polarity

Dimensional tolerance is ± 0.1 mm unless otherwise specified

Angle: ± 0.5

Unit: mm



SURFACE MOUNT LED LAMP STANDARD BRIGHT 1210

QTLP650C-23 HER/Yellow

QTLP650C-24 HER/Green

QTLP650C-34 Yellow/Green

QTLP650C-74 AlGaAs Red/Green

DISCLAIMER

FAIRCHILD SEMICONDUCTOR RESERVES THE RIGHT TO MAKE CHANGES WITHOUT FURTHER NOTICE TO ANY PRODUCTS HEREIN TO IMPROVE RELIABILITY, FUNCTION OR DESIGN. FAIRCHILD DOES NOT ASSUME ANY LIABILITY ARISING OUT OF THE APPLICATION OR USE OF ANY PRODUCT OR CIRCUIT DESCRIBED HEREIN; NEITHER DOES IT CONVEY ANY LICENSE UNDER ITS PATENT RIGHTS, NOR THE RIGHTS OF OTHERS.

LIFE SUPPORT POLICY

FAIRCHILD'S PRODUCTS ARE NOT AUTHORIZED FOR USE AS CRITICAL COMPONENTS IN LIFE SUPPORT DEVICES OR SYSTEMS WITHOUT THE EXPRESS WRITTEN APPROVAL OF THE PRESIDENT OF FAIRCHILD SEMICONDUCTOR CORPORATION. As used herein:

1. Life support devices or systems are devices or systems which, (a) are intended for surgical implant into the body, or (b) support or sustain life, and (c) whose failure to perform when properly used in accordance with instructions for use provided in the labeling, can be reasonably expected to result in a significant injury of the user.
2. A critical component in any component of a life support device or system whose failure to perform can be reasonably expected to cause the failure of the life support device or system, or to affect its safety or effectiveness.