

Excellent Integrated System Limited

Stocking Distributor

Click to view price, real time Inventory, Delivery & Lifecycle Information:

[Sumida Corporation](#)
[CDRH12D78/ANP-100MC](#)

For any questions, you can email us directly:

sales@integrated-circuit.com

SMD Power Inductor CDRH12D78/A

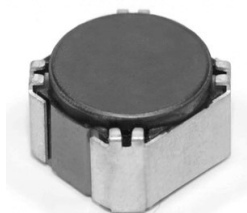

Description

- Ferrite drum core construction.
- Magnetically shielded.
- L × W × H: 12.5 × 12.5 × 8.0 mm Max.
- Product weight 4.1g(Ref.)
- Moisture Sensitivity Level: 1
- RoHS compliance.
- Qualification to AEC-Q200.

Environmental Data

- Operating temperature range: -40°C ~ +125°C (including coil's self temperature rise)
- Storage temperature range: -40°C ~ +85°C
- Solder reflow temperature: 260 °C peak.

Packaging

- Carrier tape and reel packaging.
- 13.0" diameter reel
- 500pcs per reel

Applications

- Automotive and other high temperature, high reliability application.

Dimension - [mm]

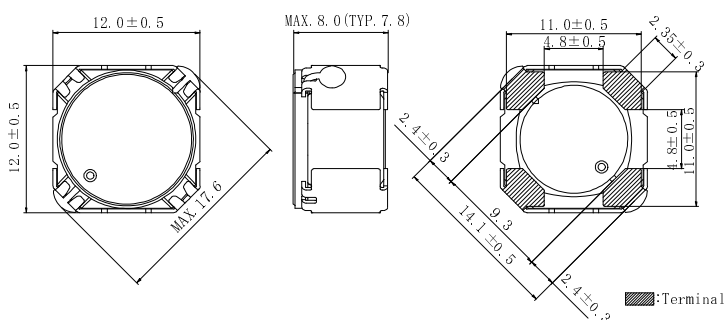

Land pattern and Schematics - [mm]

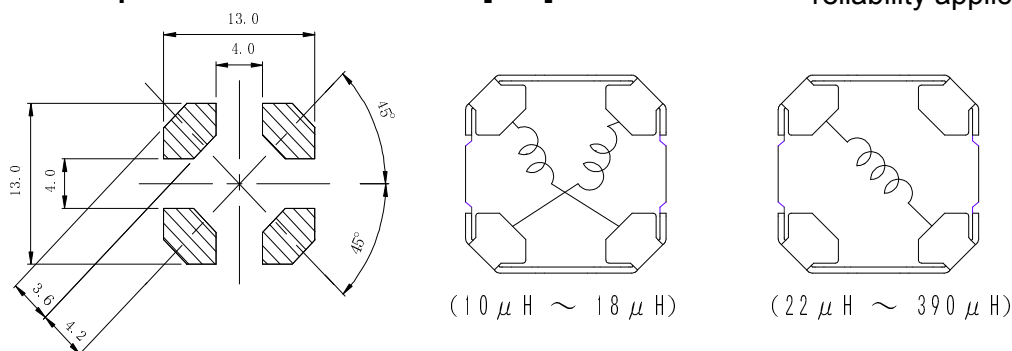

SMD Power Inductor CDRH12D78/A

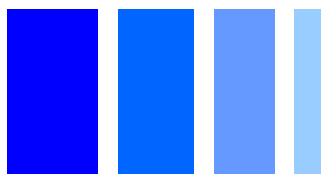

Electrical Characteristics

Part name	Stamp	Inductance (μ H) [within] ※1	D.C.R. (m Ω) [Max.].(Typ.) (at 20°C)	Rated current (A) (at 125°C) ※2
CDRH12D78/ANP-100MC	100M	10 μ H \pm 20%	22(17)	4.2
CDRH12D78/ANP-120MC	120M	12 μ H \pm 20%	24(19)	4.0
CDRH12D78/ANP-150MC	150M	15 μ H \pm 20%	27(21)	3.7
CDRH12D78/ANP-180MC	180M	18 μ H \pm 20%	29(23)	3.4
CDRH12D78/ANP-220MC	220M	22 μ H \pm 20%	44(35)	2.9
CDRH12D78/ANP-270MC	270M	27 μ H \pm 20%	47(37)	2.7
CDRH12D78/ANP-330MC	330M	33 μ H \pm 20%	64(51)	2.4
CDRH12D78/ANP-390MC	390M	39 μ H \pm 20%	68(54)	2.3
CDRH12D78/ANP-470MC	470M	47 μ H \pm 20%	75(60)	2.1
CDRH12D78/ANP-560MC	560M	56 μ H \pm 20%	84(67)	1.9
CDRH12D78/ANP-680MC	680M	68 μ H \pm 20%	97(77)	1.7
CDRH12D78/ANP-820MC	820M	82 μ H \pm 20%	124(99)	1.6
CDRH12D78/ANP-101MC	101M	100 μ H \pm 20%	152(121)	1.4
CDRH12D78/ANP-121MC	121M	120 μ H \pm 20%	197(157)	1.3
CDRH12D78/ANP-151MC	151M	150 μ H \pm 20%	249(199)	1.2
CDRH12D78/ANP-181MC	181M	180 μ H \pm 20%	270(216)	1.1
CDRH12D78/ANP-221MC	221M	220 μ H \pm 20%	308(246)	1.0
CDRH12D78/ANP-271MC	271M	270 μ H \pm 20%	448(358)	0.86
CDRH12D78/ANP-331MC	331M	330 μ H \pm 20%	579(463)	0.75
CDRH12D78/ANP-391MC	391M	390 μ H \pm 20%	730(584)	0.66

※1. Measuring condition: at 100 kHz.

※2. Rated current: The DC current at which the inductance decreases to 65% of its nominal value or when $\Delta t=30^{\circ}\text{C}$, whichever is lower.

SMD Power Inductor CDRH12D78/A

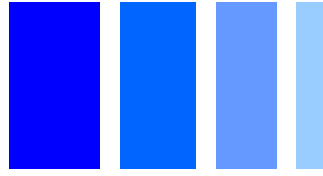

Saturation Current & Temperature Rise Graph

— L (20°C) — L (125°C) — ΔT

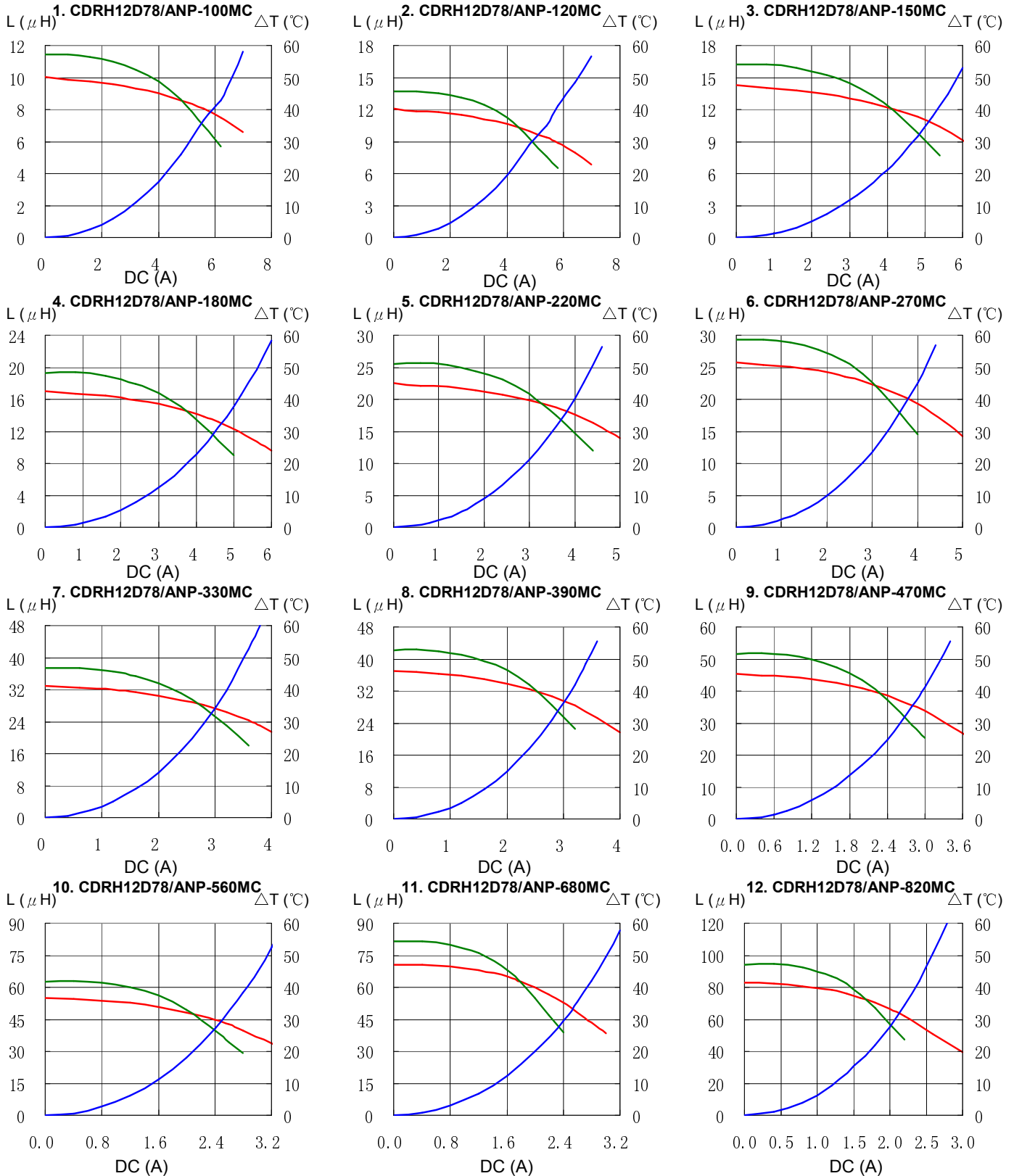

SMD Power Inductor CDRH12D78/A

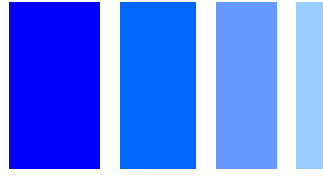

Saturation Current & Temperature Rise Graph

— L (20°C) — L (125°C) — ΔT

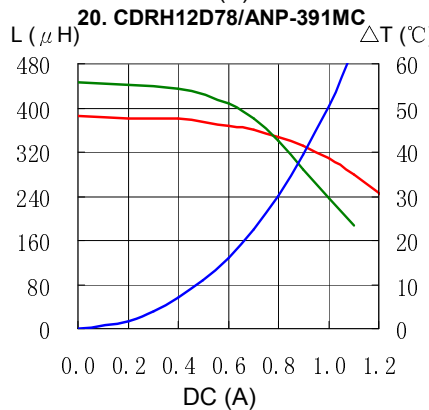
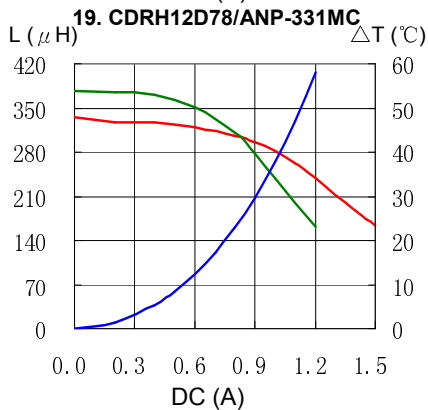
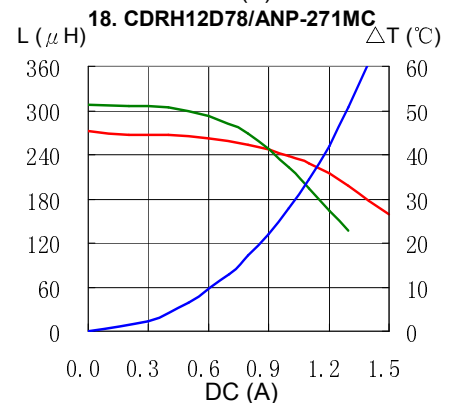
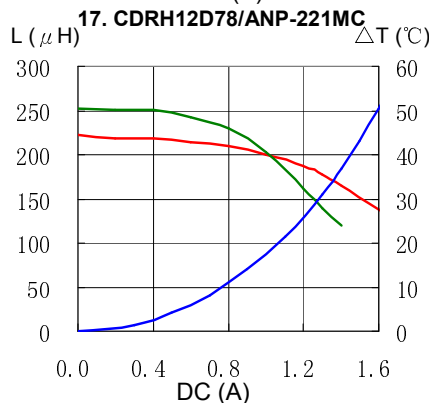
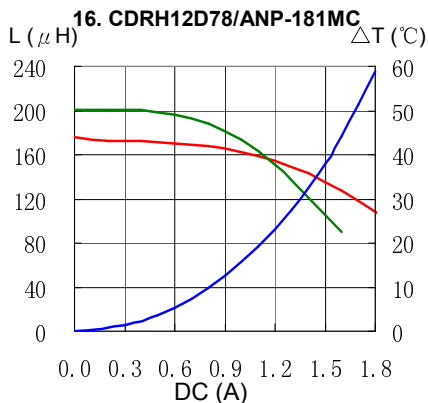
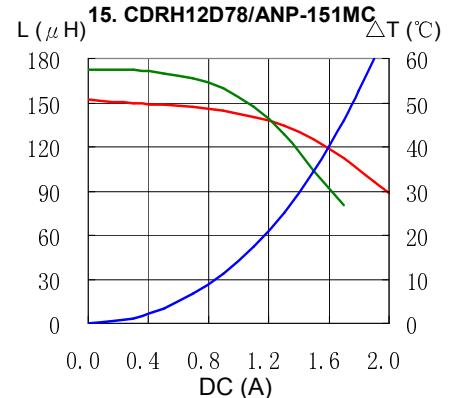
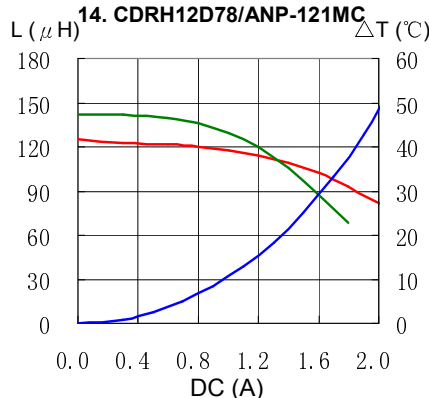
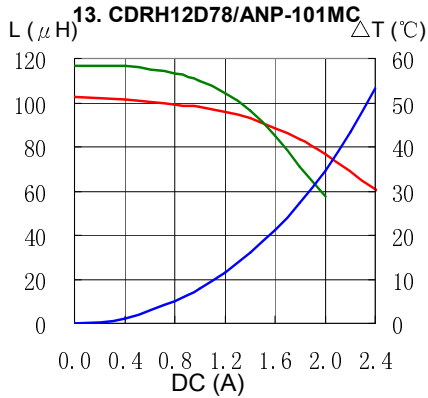

SMD Power Inductor CDRH12D78/A



Solder Reflow Condition

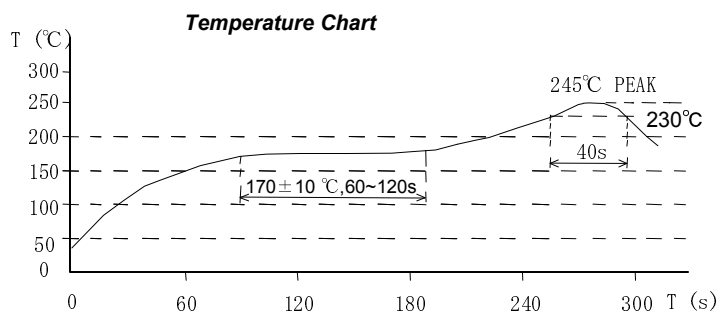
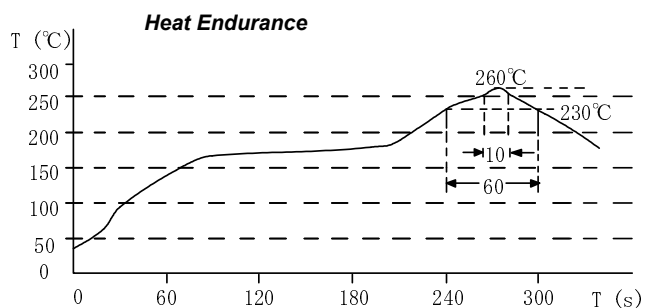

Please refer to the sales offices on our website - <http://www.sumida.com>

Hong Kong

Tel. +852-2880-6781
 FAX. +852-2565-9600
sales@hk.sumida.com

Saitama(Japan)

Tel. +81-48-691-7300
 FAX. +81-48-691-7340
sales@jp.sumida.com

Chicago

Tel. +1-847-545-6700
 FAX. +1-847-545-6720
sales@us.sumida.com

Shanghai

Tel. +86-21-5836-3299
 FAX. +86-21-5836-3266
shanghai.sales@cn.sumida.com

Seoul

Tel. +82-2-6237-0777
 FAX. +82-2-6237-0778
sales@kr.sumida.com

Oberzell

Tel. +49-8591-937-0
 FAX. +49-8591-937-103
contact@eu.sumida.com

Shenzhen

Tel. +86-755-8291-0228
 FAX. +86-755-8291-0338
shenzhen.sales@cn.sumida.com

Singapore

Tel. +65-6296-3388
 FAX. +65-6841-4426
sales@sg.sumida.com

Neumarkt

Tel. +49-9181-4509-110
 FAX. +49-9181-4509-310
infocomp@eu.sumida.com

Taipei

Tel. +886-2-8751-2737
 FAX. +886-2-8751-2738
sales@tw.sumida.com

San Jose

Tel. +1-408-321-9660
 FAX. +1-408-321-9308
sales@us.sumida.com