

Excellent Integrated System Limited

Stocking Distributor

Click to view price, real time Inventory, Delivery & Lifecycle Information:

[Vishay Semiconductor/Opto Division](#)
[IL203-X009T](#)

For any questions, you can email us directly:

sales@integrated-circuit.com



IL202, IL203

Vishay Semiconductors

Optocoupler, Phototransistor Output, Low Input Current, with Base Connection

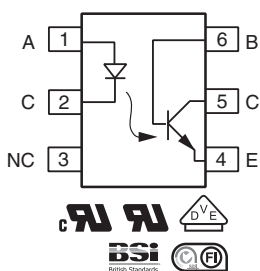
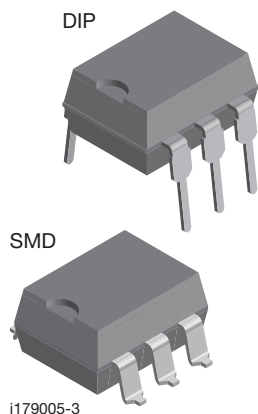

FEATURES

- Guaranteed at $I_F = 1.0 \text{ mA}$
- High collector emitter voltage, $BV_{CEO} = 70 \text{ V}$
- Long term stability
- Industry standard DIP package
- Compliant to RoHS Directive 2002/95/EC and in accordance to WEEE 2002/96/EC



RoHS
COMPLIANT

AGENCY APPROVALS

- UL file no. E52744 system code H, double protection
- cUL tested to CSA 22.2 bulletin 5A
- DIN EN 60747-5-2 (VDE 0884)/DIN EN 60747-5-5 (pending), available with option 1
- BSI: EN 60065:2002, EN 60950-1:2006
- FIMKO

DESCRIPTION

The IL202, IL203 is optically coupled pairs employing a gallium arsenide infrared LED and a silicon NPN phototransistor. Signal information, including a DC level, can be transmitted by the device while maintaining a high degree of electrical isolation between input and output. The IL202, IL203 can be used to replace relays and transformers in many digital interface applications, as well as analog applications such as CRT modulation.

ORDERING INFORMATION

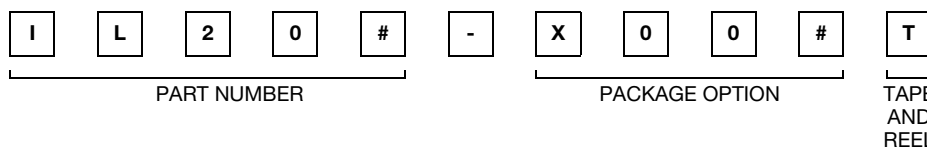

AGENCY CERTIFIED/PACKAGE	CTR (%)	
UL, cUL, BSI, FIMKO	125 to 250	225 to 450
DIP-6	-	IL203
SMD-6, option 9	-	IL203-X009T
VDE, UL, cUL, BSI, FIMKO	125 to 250	225 to 450
DIP-6	IL202-X001	-

IL202, IL203



Vishay Semiconductors Optocoupler, Phototransistor Output,
Low Input Current, with Base Connection

ABSOLUTE MAXIMUM RATINGS ($T_{amb} = 25\text{ }^{\circ}\text{C}$, unless otherwise specified)				
PARAMETER	TEST CONDITION	SYMBOL	VALUE	UNIT
INPUT				
Peak reverse voltage		V_R	6.0	V
Forward continuous current		I_F	60	mA
Power dissipation		P_{diss}	100	mW
Derate linearly from 25 °C			1.33	mW/°C
OUTPUT				
Collector emitter breakdown voltage		BV_{CEO}	70	V
Emitter collector breakdown voltage		BV_{ECO}	7.0	V
Collector base breakdown voltage		BV_{CBO}	70	V
Power dissipation		P_{diss}	200	mW
Derate linearly from 25 °C			2.6	mW/°C
COUPLER				
Isolation test voltage	$t = 1.0\text{ s}$	V_{ISO}	5300	V_{RMS}
Total package dissipation (LED and detector)		P_{tot}	250	mW
Derate linearly from 25 °C			3.3	mW/°C
Creepage distance			≥ 7.0	mm
Clearance distance			≥ 7.0	mm
Storage temperature		T_{stg}	- 55 to + 150	°C
Operating temperature		T_{amb}	- 55 to + 100	°C
Lead soldering time	$\leq 260\text{ }^{\circ}\text{C}$		10	s

Note

- Stresses in excess of the absolute maximum ratings can cause permanent damage to the device. Functional operation of the device is not implied at these or any other conditions in excess of those given in the operational sections of this document. Exposure to absolute maximum ratings for extended periods of the time can adversely affect reliability.

ELECTRICAL CHARACTERISTICS ($T_{amb} = 25\text{ }^{\circ}\text{C}$, unless otherwise specified)						
PARAMETER	TEST CONDITION	SYMBOL	MIN.	TYP.	MAX.	UNIT
INPUT						
Forward voltage	$I_F = 20\text{ mA}$	V_F		1.2	1.5	V
	$I_F = 1.0\text{ mA}$	V_F		1.0	1.2	V
Breakdown voltage	$I_R = 10\text{ }\mu\text{A}$	V_F	6.0	20		V
Reverse current	$V_R = 6.0\text{ V}$	I_R		0.1	10	μA
OUTPUT						
DC forward current gain	$V_{CE} = 5.0\text{ V}, I_C = 100\text{ }\mu\text{A}$	h_{FE}	100	200		
Collector emitter breakdown voltage	$I_C = 100\text{ }\mu\text{A}$	BV_{CEO}	70			V
Emitter collector breakdown voltage	$I_E = 100\text{ }\mu\text{A}$	BV_{ECO}	7.0	10		V
Collector base breakdown voltage	$I_C = 10\text{ }\mu\text{A}$	BV_{CBO}	70	90		V
Leakage current collector emitter	$V_{CE} = 10\text{ V}, T_A = 25\text{ }^{\circ}\text{C}$	I_{CEO}		5.0	50	nA

Note

- Minimum and maximum values are testing requirements. Typical values are characteristics of the device and are the result of engineering evaluation. Typical values are for information only and are not part of the testing requirements.

CURRENT TRANSFER RATIO ($T_{amb} = 25\text{ }^{\circ}\text{C}$, unless otherwise specified)							
PARAMETER	TEST CONDITION	PART	SYMBOL	MIN.	TYP.	MAX.	UNIT
Current transfer ratio (collector to base)	$I_F = 10\text{ mA}, V_{CB} = 10\text{ V}$		CTR_{CB}	15			%
Collector emitter saturation voltage	$I_F = 10\text{ mA}, I_C = 2.0\text{ mA}$		V_{CEsat}			0.4	V
DC current transfer ratio	$I_F = 10\text{ mA}, V_{CE} = 10\text{ V}$	IL202	CTR_{DC}	125	200	250	%
		IL203	CTR_{DC}	225	300	450	%
	$I_F = 1.0\text{ mA}, V_{CE} = 10\text{ V}$	IL202	CTR_{DC}	30			%
		IL203	CTR_{DC}	50			%



IL202, IL203

Optocoupler, Phototransistor Output, Vishay Semiconductors
Low Input Current, with Base Connection

TYPICAL CHARACTERISTICS ($T_{amb} = 25\text{ }^{\circ}\text{C}$, unless otherwise specified)

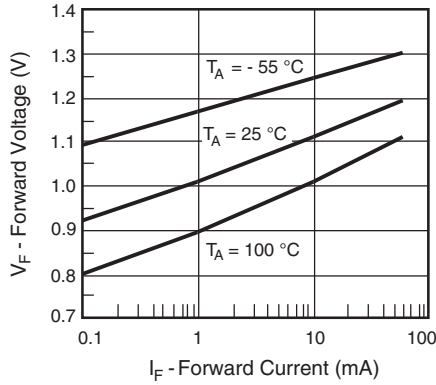

Fig. 1 - Forward Voltage vs. Forward Current

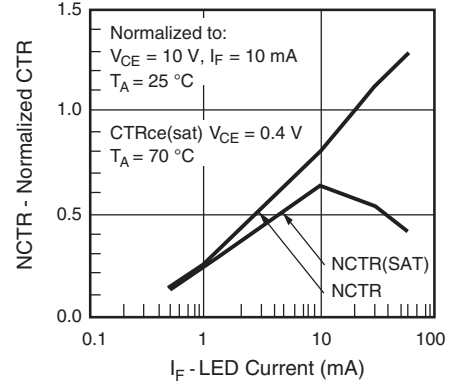

Fig. 4 - Normalized Non-Saturated and Saturated CTR vs. LED Current

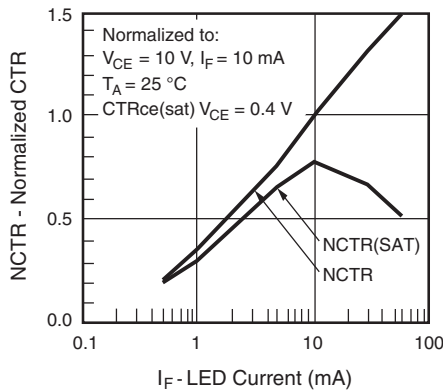

Fig. 2 - Normalized Non-Saturated and Saturated CTR vs. LED Current

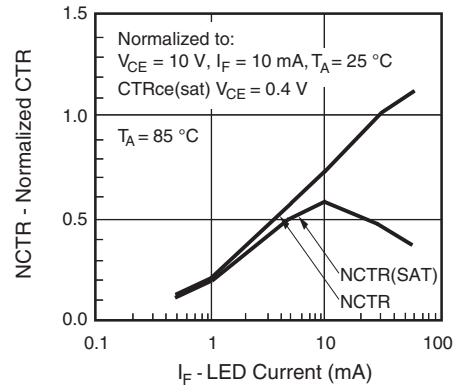

Fig. 5 - Normalized Non-Saturated and Saturated CTR vs. LED Current

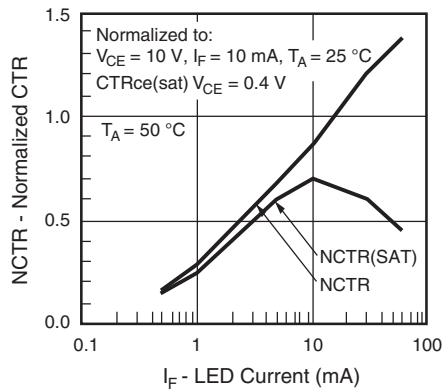

Fig. 3 - Normalized Non-Saturated and Saturated CTR vs. LED Current

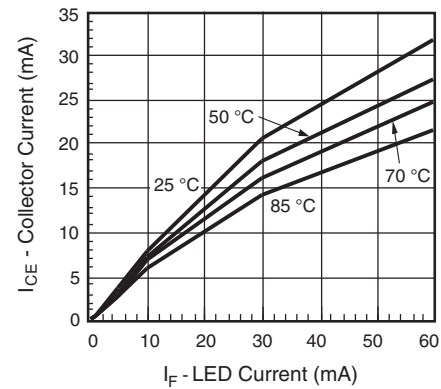

Fig. 6 - Collector Emitter Current vs. Temperature and LED Current

IL202, IL203



Vishay Semiconductors Optocoupler, Phototransistor Output,
 Low Input Current, with Base Connection

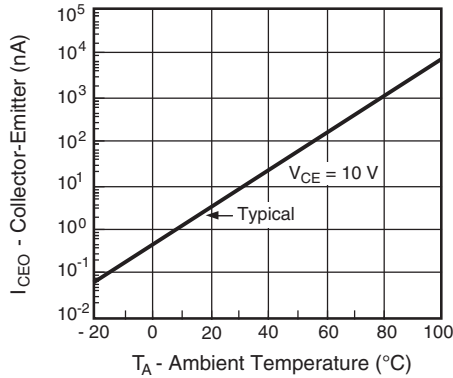

Fig. 7 - Collector Emitter Leakage Current vs. Temperature

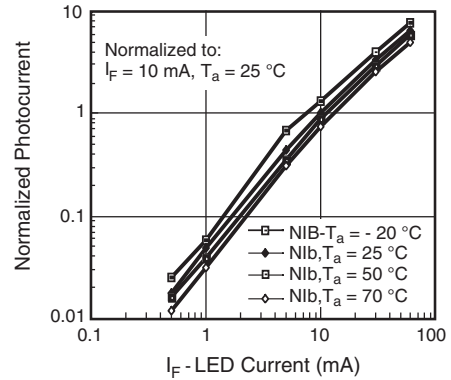

Fig. 10 - Normalized Photocurrent vs. I_F and Temperature

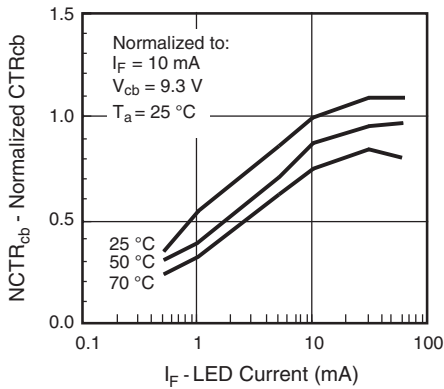

Fig. 8 - Normalized CTR_{cb} vs. LED Current and Temperature

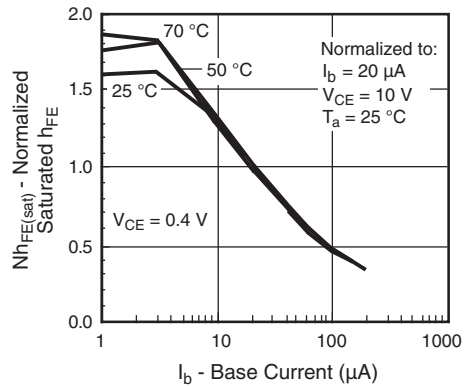

Fig. 11 - Normalized Saturated h_{FE} vs. Base Current and Temperature

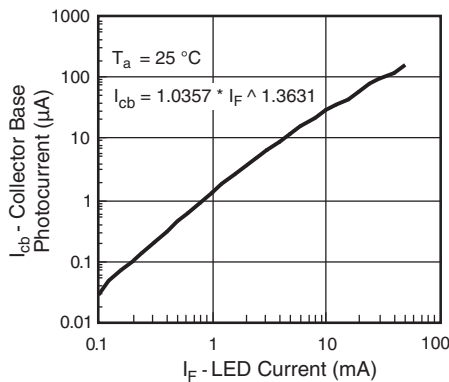

Fig. 9 - Collector Base Photocurrent vs. LED Current

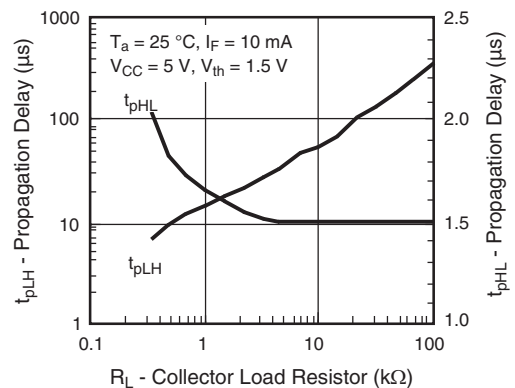

Fig. 12 - Propagation Delay vs. Collector Load Resistor



IL202, IL203

Optocoupler, Phototransistor Output, Vishay Semiconductors
Low Input Current, with Base Connection

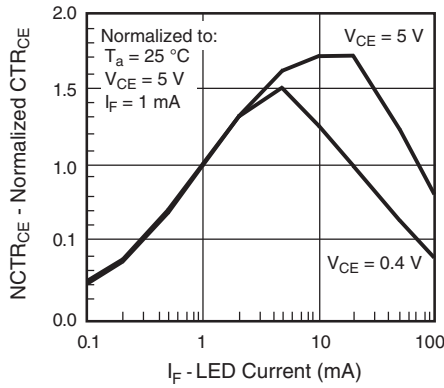

Fig. 13 - Normalized Non-Saturated and Saturated CTR_{CE} vs. LED Current

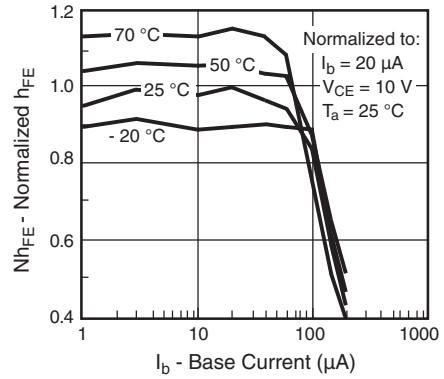
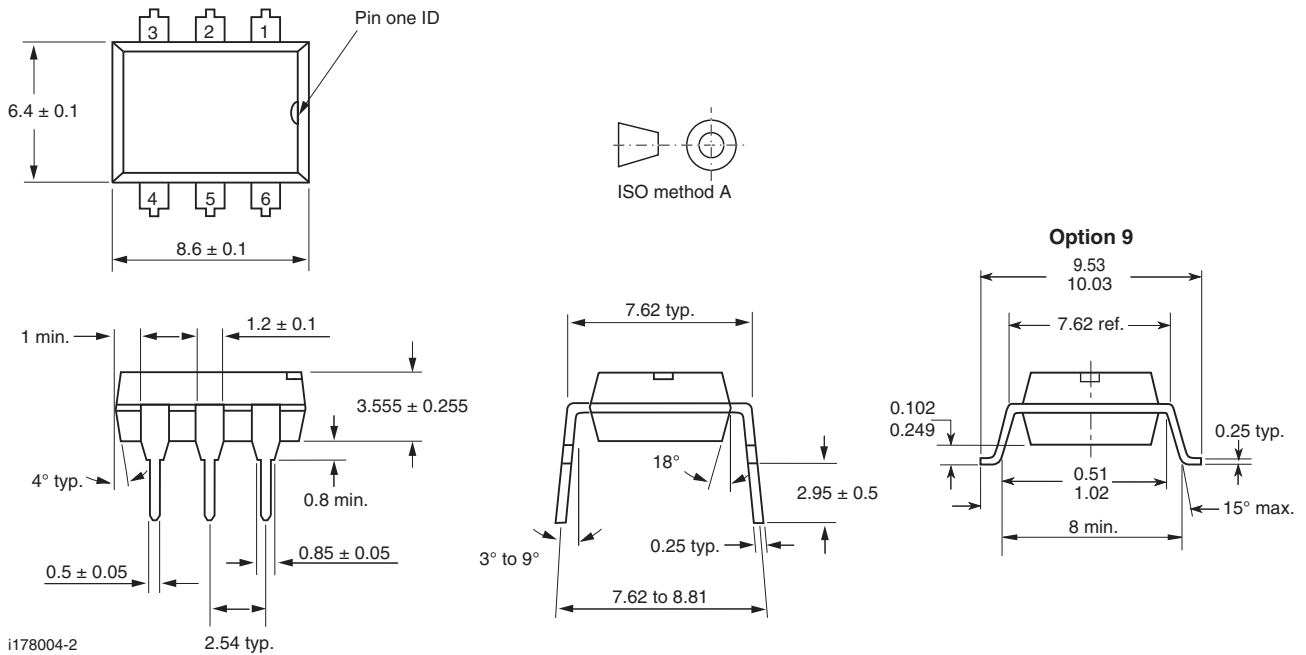

Fig. 14 - Normalized Non-Saturated h_{FE} vs. Base Current and Temperature

PACKAGE DIMENSIONS in millimeters



PACKAGE MARKING (example)



Notes

- Only option 1 is reflected in the package marking
- The VDE logo is only marked on option 1 parts
- Tape and reel suffix (T) is not part of the package marking



Disclaimer

ALL PRODUCT, PRODUCT SPECIFICATIONS AND DATA ARE SUBJECT TO CHANGE WITHOUT NOTICE TO IMPROVE RELIABILITY, FUNCTION OR DESIGN OR OTHERWISE.

Vishay Intertechnology, Inc., its affiliates, agents, and employees, and all persons acting on its or their behalf (collectively, "Vishay"), disclaim any and all liability for any errors, inaccuracies or incompleteness contained in any datasheet or in any other disclosure relating to any product.

Vishay makes no warranty, representation or guarantee regarding the suitability of the products for any particular purpose or the continuing production of any product. To the maximum extent permitted by applicable law, Vishay disclaims (i) any and all liability arising out of the application or use of any product, (ii) any and all liability, including without limitation special, consequential or incidental damages, and (iii) any and all implied warranties, including warranties of fitness for particular purpose, non-infringement and merchantability.

Statements regarding the suitability of products for certain types of applications are based on Vishay's knowledge of typical requirements that are often placed on Vishay products in generic applications. Such statements are not binding statements about the suitability of products for a particular application. It is the customer's responsibility to validate that a particular product with the properties described in the product specification is suitable for use in a particular application. Parameters provided in datasheets and / or specifications may vary in different applications and performance may vary over time. All operating parameters, including typical parameters, must be validated for each customer application by the customer's technical experts. Product specifications do not expand or otherwise modify Vishay's terms and conditions of purchase, including but not limited to the warranty expressed therein.

Except as expressly indicated in writing, Vishay products are not designed for use in medical, life-saving, or life-sustaining applications or for any other application in which the failure of the Vishay product could result in personal injury or death. Customers using or selling Vishay products not expressly indicated for use in such applications do so at their own risk. Please contact authorized Vishay personnel to obtain written terms and conditions regarding products designed for such applications.

No license, express or implied, by estoppel or otherwise, to any intellectual property rights is granted by this document or by any conduct of Vishay. Product names and markings noted herein may be trademarks of their respective owners.