

Excellent Integrated System Limited

Stocking Distributor

Click to view price, real time Inventory, Delivery & Lifecycle Information:

[IXYS Corporation](#)

[MEO550-02DA](#)

For any questions, you can email us directly:

sales@integrated-circuit.com



Fast Recovery Epitaxial Diode (FRED) Module

MEO 550-02 DA

$V_{RRM} = 200\text{ V}$
 $I_{FAVM} = 582\text{ A}$
 $t_{rr} = 150\text{ ns}$

V_{RSM}	V_{RRM}	Type
V	V	
200	200	MEO 550-02DA

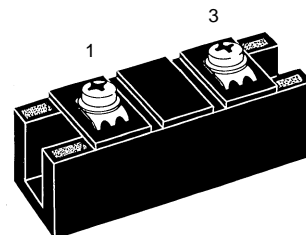
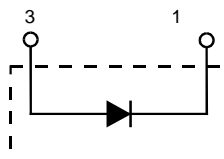

Symbol	Test Conditions	Maximum Ratings	
I_{FRMS}	$T_C = 75^\circ\text{C}$	822	A
I_{FAVM} ①	$T_C = 75^\circ\text{C}$; rectangular, d = 0.5	582	A
I_{FRM}	$t_p < 10\ \mu\text{s}$; rep. rating, pulse width limited by T_{VJM}	2880	A
I_{FSM}	$T_{VJ} = 45^\circ\text{C}$; t = 10 ms (50 Hz), sine	4800	A
	t = 8.3 ms (60 Hz), sine	5280	A
	$T_{VJ} = 150^\circ\text{C}$; t = 10 ms (50 Hz), sine	4320	A
	t = 8.3 ms (60 Hz), sine	4750	A
I^2t	$T_{VJ} = 45^\circ\text{C}$; t = 10 ms (50 Hz), sine	115200	A ² s
	t = 8.3 ms (60 Hz), sine	117100	A ² s
	$T_{VJ} = 150^\circ\text{C}$; t = 10 ms (50 Hz), sine	93300	A ² s
	t = 8.3 ms (60 Hz), sine	94800	A ² s
T_{VJ}		-40...+150	°C
T_{stg}		-40...+125	°C
T_{Smax}		110	°C
P_{tot}	$T_C = 25^\circ\text{C}$	1750	W
V_{ISOL}	50/60 Hz, RMS t = 1 min	3000	V~
	$I_{ISOL} \leq 1\text{ mA}$ t = 1 s	3600	V~
M_d	Mounting torque (M6)	2.25-2.75/20-25	Nm/lb.in.
	Terminal connection torque (M6)	4.50-5.50/40-48	Nm/lb.in.
d_s	Creep distance on surface	12.7	mm
d_A	Strike distance through air	9.6	mm
a	Maximum allowable acceleration	50	m/s ²
Weight		150	g

Features

- International standard package with DCB ceramic base plate
- Planar passivated chips
- Short recovery time
- Low switching losses
- Soft recovery behaviour
- Isolation voltage 3600 V~
- UL registered E 72873

Applications

- Antiparallel diode for high frequency switching devices
- Free wheeling diode in converters and motor control circuits
- Inductive heating and melting
- Uninterruptible power supplies (UPS)
- Ultrasonic cleaners and welders

Advantages

- High reliability circuit operation
- Low voltage peaks for reduced protection circuits
- Low noise switching
- Low losses

Symbol	Test Conditions	Characteristic Values (per diode)	
		typ.	max.
I_R	$T_{VJ} = 25^\circ\text{C}$ $V_R = V_{RRM}$		5 mA
	$T_{VJ} = 25^\circ\text{C}$ $V_R = 0.8 \cdot V_{RRM}$		4 mA
	$T_{VJ} = 125^\circ\text{C}$ $V_R = 0.8 \cdot V_{RRM}$		160 mA
V_F	$I_F = 300\text{ A}$; $T_{VJ} = 125^\circ\text{C}$		0.84 V
	$T_{VJ} = 25^\circ\text{C}$		1.10 V
	$I_F = 520\text{ A}$; $T_{VJ} = 125^\circ\text{C}$		1.08 V
	$T_{VJ} = 25^\circ\text{C}$		1.25 V
V_{T0}	For power-loss calculations only		0.52 V
r_T			1.06 mΩ
R_{thJH}	DC current		0.114 K/W
R_{thJC}	DC current		0.071 K/W
t_{rr}	$I_F = 500\text{ A}$ $V_R = 100\text{ V}$ $-di/dt = 200\text{ A}/\mu\text{s}$	150	$T_{VJ} = 100^\circ\text{C}$
			$T_{VJ} = 25^\circ\text{C}$
			$T_{VJ} = 100^\circ\text{C}$
I_{RM}			200 ns
			9 A
			15 A

① I_{FAVM} rating includes reverse blocking losses at T_{VJM} , $V_R = 0.6 V_{RRM}$, duty cycle d = 0.5
 Data according to IEC 60747

IXYS reserves the right to change limits, test conditions and dimensions

Dimensions in mm (1 mm = 0.0394")

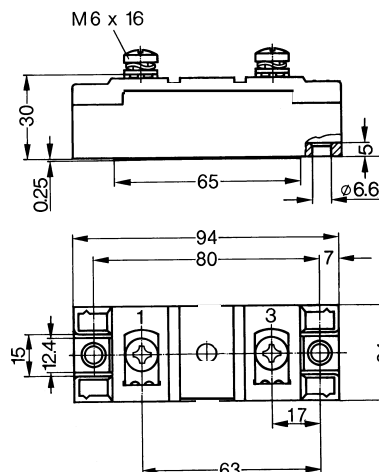

IXYS **MEO 550-02 DA**

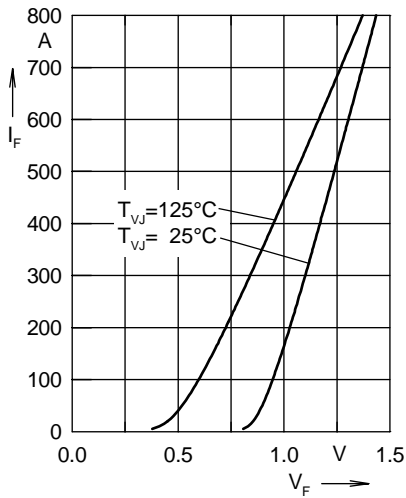

Fig. 1 Forward current I_F versus max. voltage drop V_F per leg

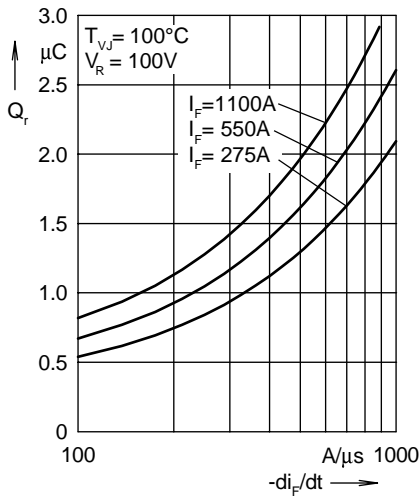

Fig. 2 Typ. reverse recovery charge Q_r versus $-di_F/dt$

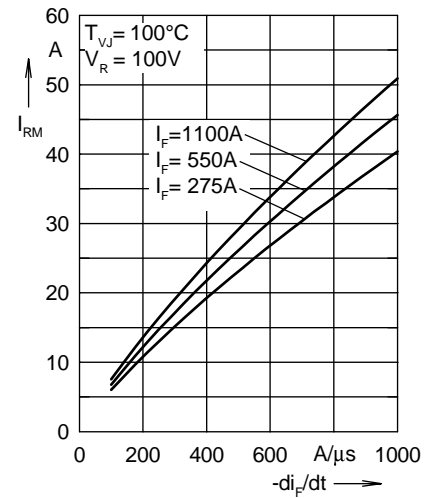

Fig. 3 Typ. peak reverse current I_{RM} versus $-di_F/dt$

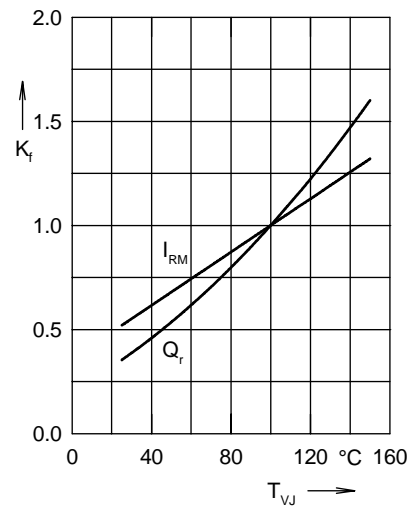

Fig. 4 Dynamic parameters Q_r , I_{RM} versus junction temperature T_{VJ}

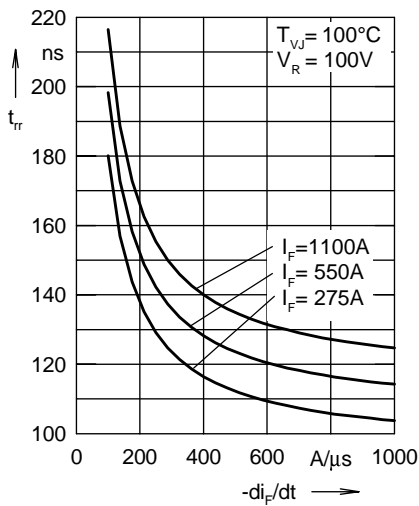

Fig. 5 Typ. recovery time t_{rr} versus $-di_F/dt$

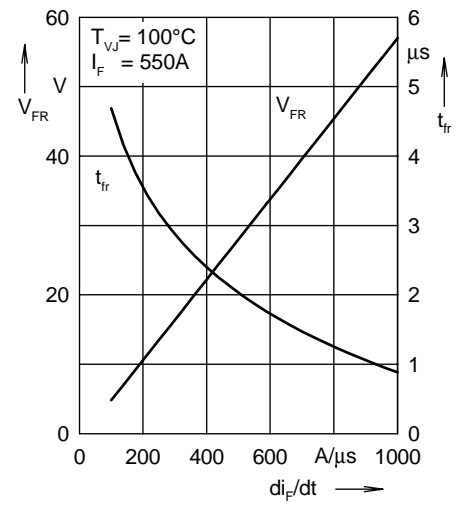

Fig. 6 Typ. peak forward voltage V_{FR} and t_{rr} versus di_F/dt

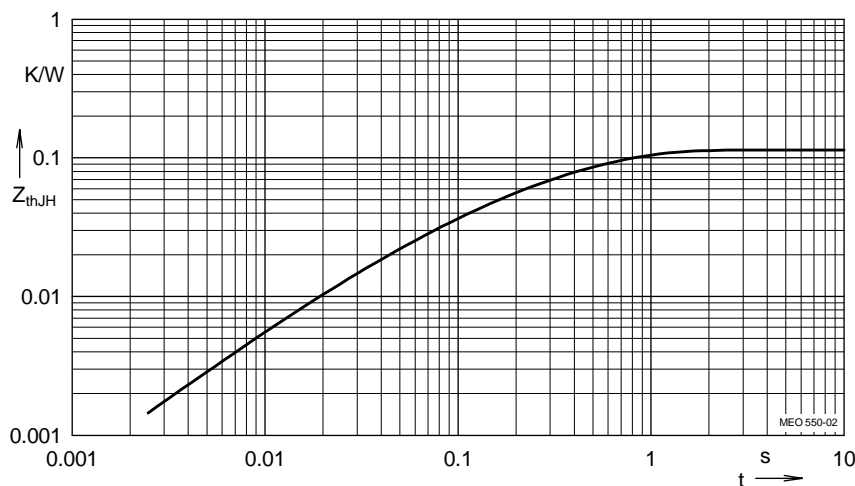

Fig. 7 Transient thermal impedance junction to heatsink

Constants for Z_{thJS} calculation:

i	R_{thi} (K/W)	t_i (s)
1	0.001	0.08
2	0.004	0.024
3	0.027	0.112
4	0.082	0.464