

## Excellent Integrated System Limited

Stocking Distributor

Click to view price, real time Inventory, Delivery & Lifecycle Information:

[Bel Fuse Inc.](#)  
[1840480-6](#)

For any questions, you can email us directly:  
[sales@integrated-circuit.com](mailto:sales@integrated-circuit.com)

THIS DRAWING AND THE SUBJECT MATTER SHOWN THEREON ARE CONFIDENTIAL AND THE PROPERTY OF BEL/STEWART/TRP CONNECTOR AND SHALL NOT BE REPRODUCED, COPIED, OR USED IN ANY MANNER WITHOUT THE WRITTEN CONSENT OF TRP CONNECTOR.

PRODUCT MAY BE PROTECTED BY ONE OR MORE OF THE FOLLOWING US PATENTS:  
 6736910-6939956-6426781-6428361-6584638-6840817-7123117  
 7429195-7717749-7808751-6217391-6149050-7924130

REVISIONS		DATE	BY	APP
1	ISSUE			
2	EC-1411035 COMPANY LOGO CHANGE	14JUN2016	TL	KZ

MECHANICAL:

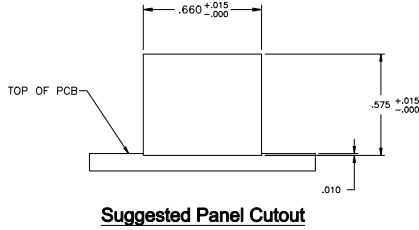
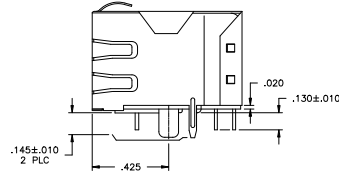
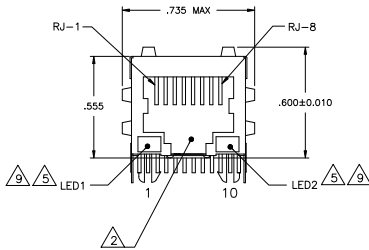
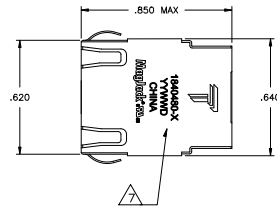

**MATERIALS:**  
 HOUSING - THERMOPLASTIC PA46 TE250F6 POLYESTER FLAMMABILITY RATING UL 94V-0.  
 SHIELD - .010" THICK, C26800 BRASS PREPLATED WITH 30µINCH SEMI-BRIGHT NICKEL. SOLDER TABS POST DIPPED WITH 100µINCH MIN SAC SOLDER.  
 MOD JACK CONTACTS - 0.0157 X 0.018" PHOSPHOR BRONZE, 50µINCH MIN OVERALL NICKEL UNDERPLATE, WITH SELECT 50µINCH MIN HARD GOLD FINISH PLATE SOLDER TAILS WITH 100µINCH MIN MATTE TIN AND/OR SAC SOLDER DIP.  
 LIGHT EMITTING DIODE(LED) - DIFFUSED EPOXY LENS, .020" x .020" CARBON STEEL WIREFRAME LEADS PRE-PLATED WITH 50µINCH SILVER OVER 4µINCH NICKEL UNDERPLATE OVER 4µINCH COPPER UNDERPLATE. POST-PLATED WITH 100µINCH MIN MATTE TIN AND/OR SAC SOLDER DIP OR PURE TIN SOLDER DIP.

**RJ45 JACK CAVITY CONFORMS TO FCC RULES AND REGULATIONS PART 68, SUB PART F.**

**MAGNETICS**  
 -APPLICATION: 10/100/1000 BASE-T  
 -IMPEDANCE: 100 OHMS  
 -TURNS RATIO (CHIP-CABLE): 1:1 ALL FOUR PAIRS  
 -OPEN CIRCUIT INDUCTANCE (OCL): 350nH MIN @100MHz, 0.1VRMS, 8mADC BIAS FROM 0°C TO 70°C, ALL FOUR PAIRS  
 -ALL FOUR PAIRS BI-DIRECTIONAL  
**PERFORMANCE @ 25°C:**  
 INSERTION LOSS (IL): 1dB MAX FROM 0.5MHz TO 100MHz  
 RETURN LOSS (RL): 18dB MIN FROM 0.5MHz TO 40MHz  
 12-20LOG(f/80)dB MIN FROM 4.0MHz TO 100MHz  
 CROSSTALK ATTENUATION: 35dB MIN FROM 0.5MHz TO 40MHz  
 33-20LOG(f/50)dB MIN FROM 4.0MHz TO 100MHz  
 COMMON MODE REJECTION RATIO (CMRR): 30dB MIN FROM 0.5MHz TO 100MHz  
 - ISOLATION VOLTAGE: 2250VDC (MAX) FOR 60 SECONDS WITH A RISE TIME OF 500V/SEC.

**4. OPERATING TEMPERATURE: FROM 0°C TO +70°C.**

**LEDS WITHOUT BUILT-IN RESISTOR**  
 LEADS ARE DRIVEN WITH CONSTANT CURRENT AT APPROX 20 mA  
 LED COLOR: DOMINANT WAVELENGTH (λD): GREEN 568 nm TYP @ IF=20 mA  
 FORWARD VOLTAGE (VF): GREEN 2.2V TYP @ IF=20 mA  
 DOMINANT WAVELENGTH (λD): YELLOW 588 nm TYP @ IF=20 mA  
 FORWARD VOLTAGE (VF): YELLOW 2.1V TYP @ IF=20 mA

**INDICATED MAGNETIC CONNECTIONS ARE SYMMETRICAL TO SUPPORT AUTO-MDI/MDIX.**

**TRP CONNECTOR LOGO, PART NUMBER, DATE CODE, COUNTRY OF ORIGIN AND AGENCY APPROVAL MARKING IN APPROXIMATE LOCATION SHOWN.**

**THE PART IS COMPLIANT TO BOTH WAVE SOLDERING PROCESS, PREHEAT TEMPERATURE IS 150°C ABOVE, 120 SECONDS TO 180 SECONDS, PEAK SOLDERING TEMPERATURE IS 265 °C MAX, 10 SECONDS MAX; AND IR REFLOW SOLDERING PROCESS, PEAK SOLDERING TEMPERATURE 260°C MAX DURATION TIME 10 SECONDS MAX, OVER 230 °C WITHIN 40 SECONDS TO 60 SECONDS.**

**LED LENS ARE RECESSED TO SHIELD SURFACE**

THIS DRAWING IS A CONTROLLED DOCUMENT.		REVISED	DATE	BY	APP
DESIGNER	DATE	APPROVED			
DRG NO	ISSUE NO	DATE			
REV	DATE	BY			
1					
2					
3					
4					
5					
6					
7					
8					
9					
10					
11					
12					
13					
14					
15					
16					
17					
18					
19					
20					
21					
22					
23					
24					
25					
26					
27					
28					
29					
30					
31					
32					
33					
34					
35					
36					
37					
38					
39					
40					
41					
42					
43					
44					
45					
46					
47					
48					
49					
50					
51					
52					
53					
54					
55					
56					
57					
58					
59					
60					
61					
62					
63					
64					
65					
66					
67					
68					
69					
70					
71					
72					
73					
74					
75					
76					
77					
78					
79					
80					
81					
82					
83					
84					
85					
86					
87					
88					
89					
90					
91					
92					
93					
94					
95					
96					
97					
98					
99					
100					

**ELECTRICAL:**

**4G05P1 Series GIGABIT Magnetic Circuit**

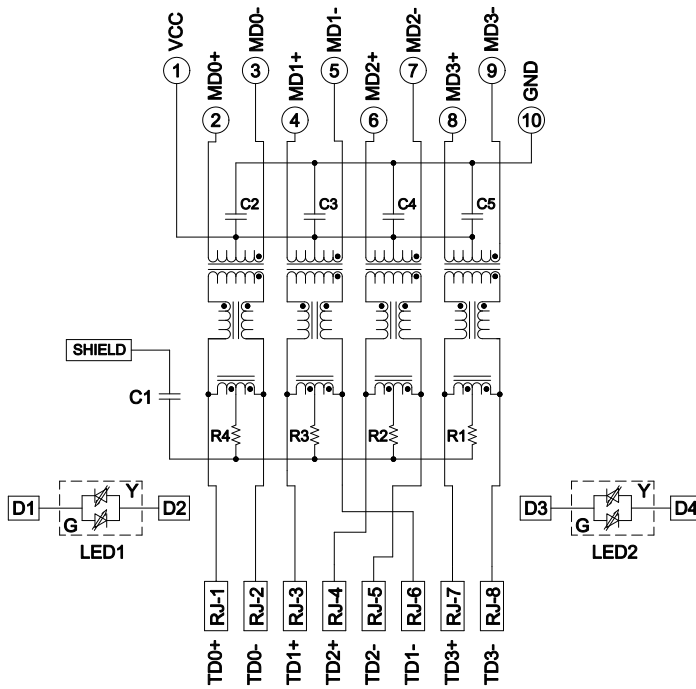

**C1 = 1000 pF, 2kV CAPACITOR**

**R1-R4 = 75 OHMS, 1/16 W RESISTORS**

**C2-C5 = 0.1uF, 50V, X7R CAPACITORS**

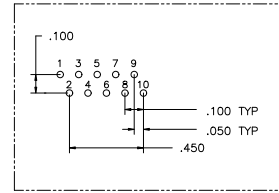

**Pin Designations**

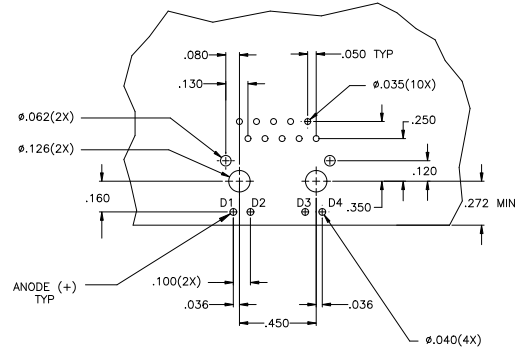

**Suggested PCB Layout  
(Component Side)**

THIS DRAWING IS A CONTROLLED DOCUMENT.		DESIGNED BY: JIN LEE	PROCESSED BY: JIN LEE		DONGGUAN CHINA
DATE: 10/10/2014	REV: 0	DESIGNED BY: JIN LEE	PROCESSED BY: JIN LEE		
PROJECT NO: 108-104004	DESCRIPTION: MAGJACK	DATE: 10/10/2014	REV: 0	1X1 4G05P1 GIGABIT TAB DOWN W/ LED	
				SINGLE NON-POE	
				A1 ©=1840480	
				CUSTOMER DRAWING	
				SCALE: 1:1 SHEET: 2 OF 2	