

## Excellent Integrated System Limited

Stocking Distributor

Click to view price, real time Inventory, Delivery & Lifecycle Information:

[BUD Industries, Inc.](#)  
[SNB-3754](#)

For any questions, you can email us directly:

[sales@integrated-circuit.com](mailto:sales@integrated-circuit.com)

DESIGNED TO MEET NEMA 1, 2, 4, 4X, 12, 13 AND IP-66  
UL LISTED AND TESTED TO UL508A. UL FILE #E194432

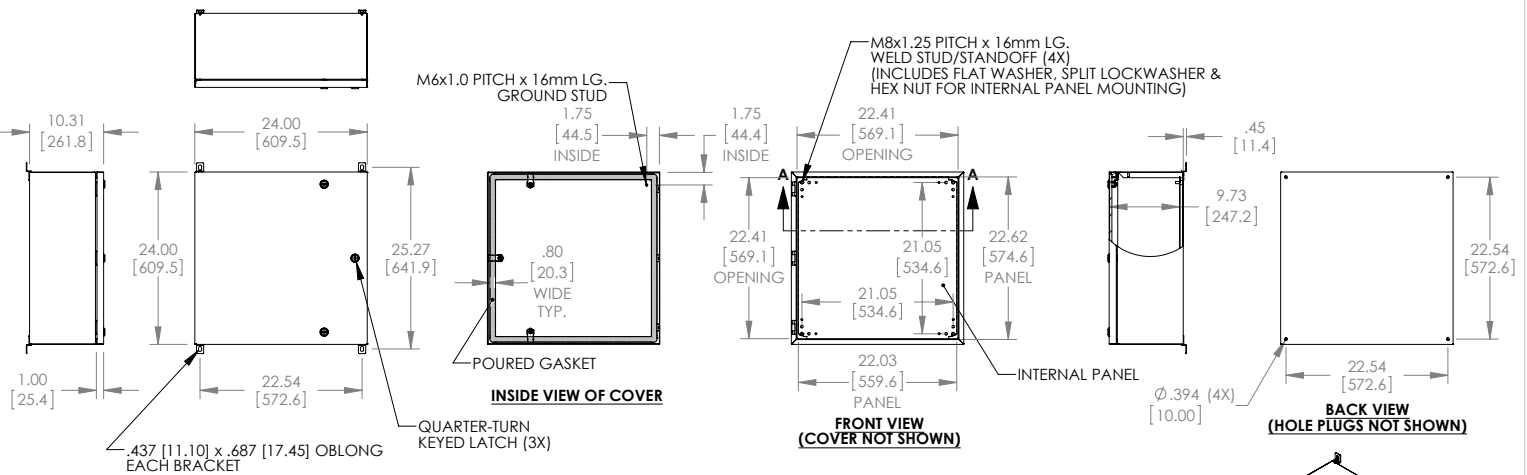

**MATERIAL:**  
 BODY & COVER - 16 GA. [1.5mm] C.R.S.  
 INTERNAL PANEL - 14 GA. [2.0mm] C.R.S.  
 WALL MOUNTING BRACKETS - 14 GA. [2.0mm] TYPE 430 STAINLESS STEEL  
 STRIKERS - 11 GA. STAINLESS STEEL 304  
 HINGE PINS & WALL MOUNTING HARDWARE - TYPE 201 STAINLESS STEEL  
 INTERNAL PANEL MOUNTING HARDWARE & GROUND STUD HARDWARE - PLAIN STEEL  
 LATCHES - ZINC DIE CAST  
 LATCH GASKET WASHER - BLACK ACRYLONITRILE-BUTADIENE RUBBER  
 POURED GASKET - BLACK POLYURETHANE FOAM  
 SEALING WASHERS - BLACK NEOPRENE  
 HOLE PLUGS - LIGHT GRAY NEOPRENE

**FINISH:**  
 BODY & COVER - LIGHT GRAY SMOOTH POWDER COAT  
 INTERNAL PANEL, INTERNAL PANEL MOUNTING HARDWARE & GROUND STUD HARDWARE - CLEAR ZINC PLATED  
 WALL MOUNTING BRACKETS, STRIKERS & HINGE PINS - NATURAL  
 LATCHES - CHROME PLATED

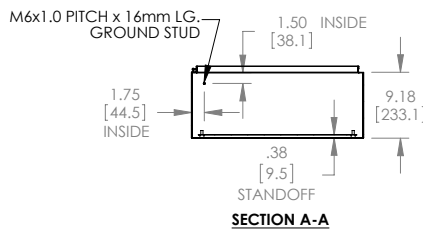

**SUPPLIED WALL MOUNTING BRACKET KIT CONTAINS:**  
 QTY. (4) WALL MOUNTING BRACKETS  
 QTY. (4) HEX HEAD BOLT M10x1.5 PITCH x 19.5mm LG.  
 QTY. (8) SEALING WASHERS  
 QTY. (4) FLAT WASHERS M10  
 QTY. (4) SPLIT LOCKWASHERS M10  
 QTY. (4) HEX NUTS M10x1.5

**SUPPLIED GROUNDING KIT CONTAINS:**  
 QTY. (1) GROUND WIRE 14-16 GA. YELLOW/GREEN WITH RING TERMINAL (M6) AT EACH END  
 QTY. (4) FLAT WASHER M6  
 QTY. (2) SPLIT LOCKWASHER M6  
 QTY. (2) HEX NUT M6x1.0

