

Excellent Integrated System Limited

Stocking Distributor



Click to view price, real time Inventory, Delivery & Lifecycle Information:

[Harting](#)
[09350120311](#)

For any questions, you can email us directly:
sales@integrated-circuit.com

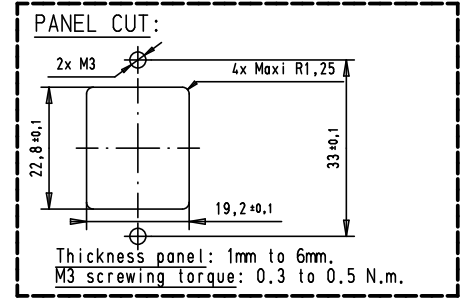
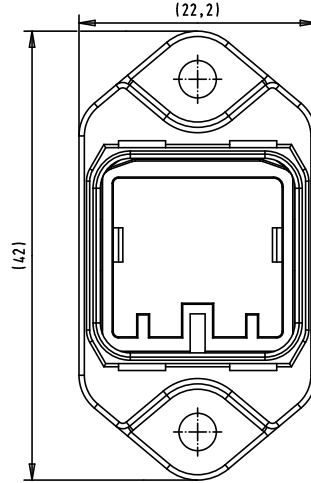
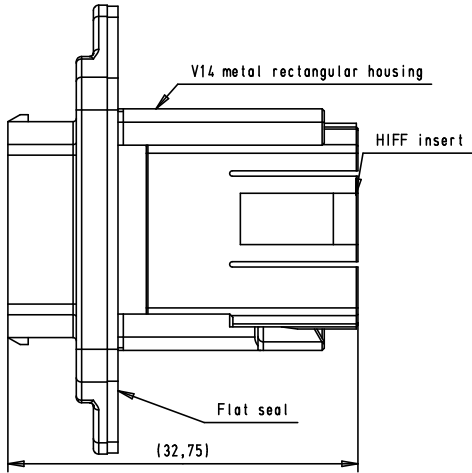
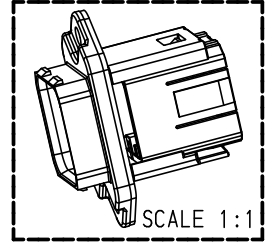
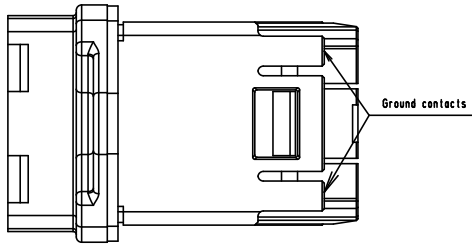
Alle Rechte vorbehalten/ All rights reserved



				Det.	Name	 All Dim. in mm Orig. Size DIN A 4	HARTING V14 metal panel feed through housing with HIFF adapter	Meßstab/ Scale
			Detail.	25/01/11	AB			2:1
			Insp.	25/01/11	JMV			
			Stand.					Blatt/ Page
36316	13/12/11	AB	HARTING EURL F-95972 Paris				TB 09 35 012 0311	1 1
Mod.	Del.	Name					Sub.	