

## **Excellent Integrated System Limited**

Stocking Distributor

Click to view price, real time Inventory, Delivery & Lifecycle Information:

[Infineon Technologies](#)

[IPP65R074C6XKSA1](#)

For any questions, you can email us directly:

[sales@integrated-circuit.com](mailto:sales@integrated-circuit.com)

## MOSFET

Metal Oxide Semiconductor Field Effect Transistor

### CoolMOS™ C6 650V

650V CoolMOS™ C6 Power Transistor  
IPP65R074C6

## Data Sheet

Rev. 2.1  
Final



## 650V CoolMOS™ C6 Power Transistor

IPP65R074C6

### 1 Description

CoolMOS™ is a revolutionary technology for high voltage power MOSFETs, designed according to the superjunction (SJ) principle and pioneered by Infineon Technologies. CoolMOS™ C6 series combines the experience of the leading SJ MOSFET supplier with high class innovation. The resulting devices provide all benefits of a fast switching SJ MOSFET while not sacrificing ease of use. Extremely low switching and conduction losses make switching applications even more efficient, more compact, lighter and cooler.

### Features

- Extremely low losses due to very low FOM  $R_{ds(on)} \cdot Q_g$  and Eoss
- Very high commutation ruggedness
- Easy to use/drive
- Pb-free plating, Halogen free mold compound
- Qualified for industrial grade applications according to JEDEC (J-STD20 and JESD22)

### Applications

PFC stages, hard switching PWM stages and resonant switching PWM stages for e.g. PC Silverbox, Adapter, LCD & PDP TV, Lighting, Server, Telecom, UPS and Solar.

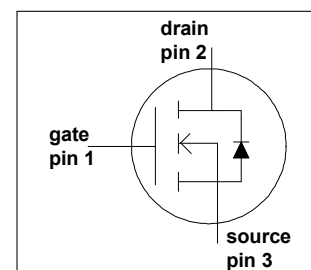
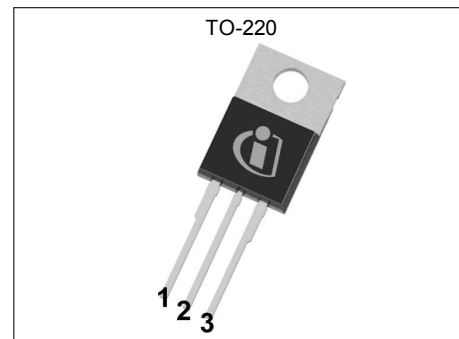

**Table 1 Key Performance Parameters**

Parameter	Value	Unit
$V_{DS} @ T_{j \max}$	700	V
$R_{DS(on),max}$	0.074	$\Omega$
$Q_g,typ$	138	nC
$I_D,pulse$	151	A
$E_{oss} @ 400V$	10.8	$\mu J$
Body diode $di/dt$	300	A/ $\mu s$

Type / Ordering Code	Package	Marking	Related Links
IPP65R074C6	PG-TO 220	65C6074	see Appendix A



## 650V CoolMOS™ C6 Power Transistor

IPP65R074C6

---

### Table of Contents

Description .....	2
Table of Contents .....	3
Maximum ratings .....	4
Thermal characteristics .....	5
Electrical characteristics .....	6
Electrical characteristics diagrams .....	8
Test Circuits .....	12
Package Outlines .....	13
Appendix A .....	14
Revision History .....	15
Disclaimer .....	15



## 650V CoolMOS™ C6 Power Transistor

IPP65R074C6

## 2 Maximum ratings

 at  $T_j = 25^\circ\text{C}$ , unless otherwise specified

**Table 2 Maximum ratings**

Parameter	Symbol	Values			Unit	Note / Test Condition
		Min.	Typ.	Max.		
Continuous drain current <sup>1)</sup>	$I_D$			57.7	A	$T_C = 25^\circ\text{C}$
				31.6		$T_C = 100^\circ\text{C}$
Pulsed drain current <sup>2)</sup>	$I_{D,pulse}$			151	A	$T_C = 25^\circ\text{C}$
Avalanche energy, single pulse	$E_{AS}$			915	mJ	$t_b = 8.1\text{A}$ , $V_{DD} = 50\text{V}$
Avalanche energy, repetitive	$E_{AR}$			1.40	mJ	$t_b = 8.1\text{A}$ , $V_{DD} = 50\text{V}$
Avalanche current, repetitive	$I_{AR}$			8.1	A	
MOSFET dv/dt ruggedness	dv/dt			50	V/ns	$V_{DS} = 0 \dots 480\text{V}$
Gate source voltage	$V_{GS}$	-20		20	V	static
		-30		30		AC ( $f > 1\text{ Hz}$ )
Power dissipation (non FullPAK) TO-220	$P_{tot}$			480.8	W	$T_C = 25^\circ\text{C}$
Operating and storage temperature	$T_j, T_{stg}$	-55		150	$^\circ\text{C}$	
Mounting torque (non FullPAK) TO-220				60	Ncm	M3 and M3.5 screws
Continuous diode forward current	$I_S$			50.0	A	$T_C = 25^\circ\text{C}$
Diode pulse current	$I_{S,pulse}$			151	A	$T_C = 25^\circ\text{C}$
Reverse diode dv/dt <sup>3)</sup>	dv/dt			15	V/ns	$V_{DS} = 0 \dots 400\text{V}$ , $t_{SD} \leq t_b$ , $T_j = 25^\circ\text{C}$
Maximum diode commutation speed	$di_f/dt$			300	A/ $\mu\text{s}$	

<sup>1)</sup> Limited by  $T_{j\text{ max}}$ . Maximum duty cycle  $D=0.75$ 
<sup>2)</sup> Pulse width  $t_p$  limited by  $T_{j\text{ max}}$



650V CoolMOS™ C6 Power Transistor

IPP65R074C6

### 3 Thermal characteristics

**Table 3 Thermal characteristics TO-220**

Parameter	Symbol	Values			Unit	Note / Test Condition
		Min.	Typ.	Max.		
Thermal resistance, junction - case	$R_{thJC}$			0.26	°C/W	
Thermal resistance, junction - ambient	$R_{thJA}$			62	°C/W	leaded
Soldering temperature, wavesoldering only allowed at leads	$T_{sold}$			260	°C	1.6 mm (0.063 in.) from case for 10s



## 650V CoolMOS™ C6 Power Transistor

IPP65R074C6

## 4 Electrical characteristics

 at  $T_j = 25^\circ\text{C}$ , unless otherwise specified

**Table 4 Static characteristics**

Parameter	Symbol	Values			Unit	Note / Test Condition
		Min.	Typ.	Max.		
Drain-source breakdown voltage	$V_{(BR)DSS}$	650			V	$V_{GS} = 0V, I_D = 1mA$
Gate threshold voltage	$V_{GS(th)}$	2.5	3	3.5	V	$V_{DS} = V_{GS}, I_D = 1.4mA$
Zero gate voltage drain current	$I_{DSS}$			5	$\mu A$	$V_{DS} = 650V, V_{GS} = 0V, T_j = 25^\circ C$
			50			$V_{DS} = 650V, V_{GS} = 0V, T_j = 150^\circ C$
Gate-source leakage current	$I_{GSS}$			100	nA	$V_{GS} = 20V, V_{DS} = 20V$
Drain-source on-state resistance	$R_{DS(on)}$		0.067	0.074	$\Omega$	$V_{GS} = 10V, I_D = 13.9A, T_j = 25^\circ C$
			0.173			$V_{GS} = 10V, I_D = 13.9A, T_j = 150^\circ C$
Gate resistance	$R_G$		0.6		$\Omega$	$f = 1MHz, \text{open drain}$

**Table 5 Dynamic characteristics**

Parameter	Symbol	Values			Unit	Note / Test Condition
		Min.	Typ.	Max.		
Input capacitance	$C_{iss}$		3020		pF	$V_{GS} = 0V, V_{DS} = 100V, f = 1MHz$
Output capacitance	$C_{oss}$		170		pF	
Effective output capacitance, energy related <sup>1)</sup>	$C_{o(er)}$		118		pF	$V_{GS} = 0V, V_{DS} = 0 \dots 480V$
Effective output capacitance, time related <sup>2)</sup>	$C_{o(tr)}$		580		pF	$I_D = \text{constant}, V_{GS} = 0V, V_{DS} = 0 \dots 480V$
Turn-on delay time	$t_{d(on)}$		11		ns	$V_{DD} = 400V, V_{GS} = 13V, I_D = 20.8A, R_G = 1.8\Omega$
Rise time	$t_r$		7		ns	
Turn-off delay time	$t_{d(off)}$		56		ns	
Fall time	$t_f$		4		ns	

**Table 6 Gate charge characteristics**

Parameter	Symbol	Values			Unit	Note / Test Condition
		Min.	Typ.	Max.		
Gate to source charge	$Q_{gs}$		17		nC	$V_{DD} = 480V, I_D = 20.8A, V_{GS} = 0 \text{ to } 10V$
Gate to drain charge	$Q_{gd}$		71		nC	
Gate charge total	$Q_g$		138		nC	
Gate plateau voltage	$V_{plateau}$		5.5		V	

<sup>1)</sup>  $C_{o(er)}$  is a fixed capacitance that gives the same stored energy as  $C_{oss}$  while  $V_{DS}$  is rising from 0 to 80%  $V_{(BR)DSS}$



650V CoolMOS™ C6 Power Transistor

IPP65R074C6

**Table 7 Reverse diode characteristics**

Parameter	Symbol	Values			Unit	Note / Test Condition
		Min.	Typ.	Max.		
Diode forward voltage	$V_{SD}$		0.9		V	$V_{GS} = 0V, I_F = 20.8A, T_j = 25^\circ C$
Reverse recovery time	$t_{rr}$		560		ns	$V_R = 400V, I_F = 20.8A, dI/dt = 100A/\mu s$
Reverse recovery charge	$Q_{rr}$		12		$\mu C$	
Peak reverse recovery current	$I_{rrm}$		40		A	





650V CoolMOS™ C6 Power Transistor

IPP65R074C6

5 Electrical characteristics diagrams

Table 8

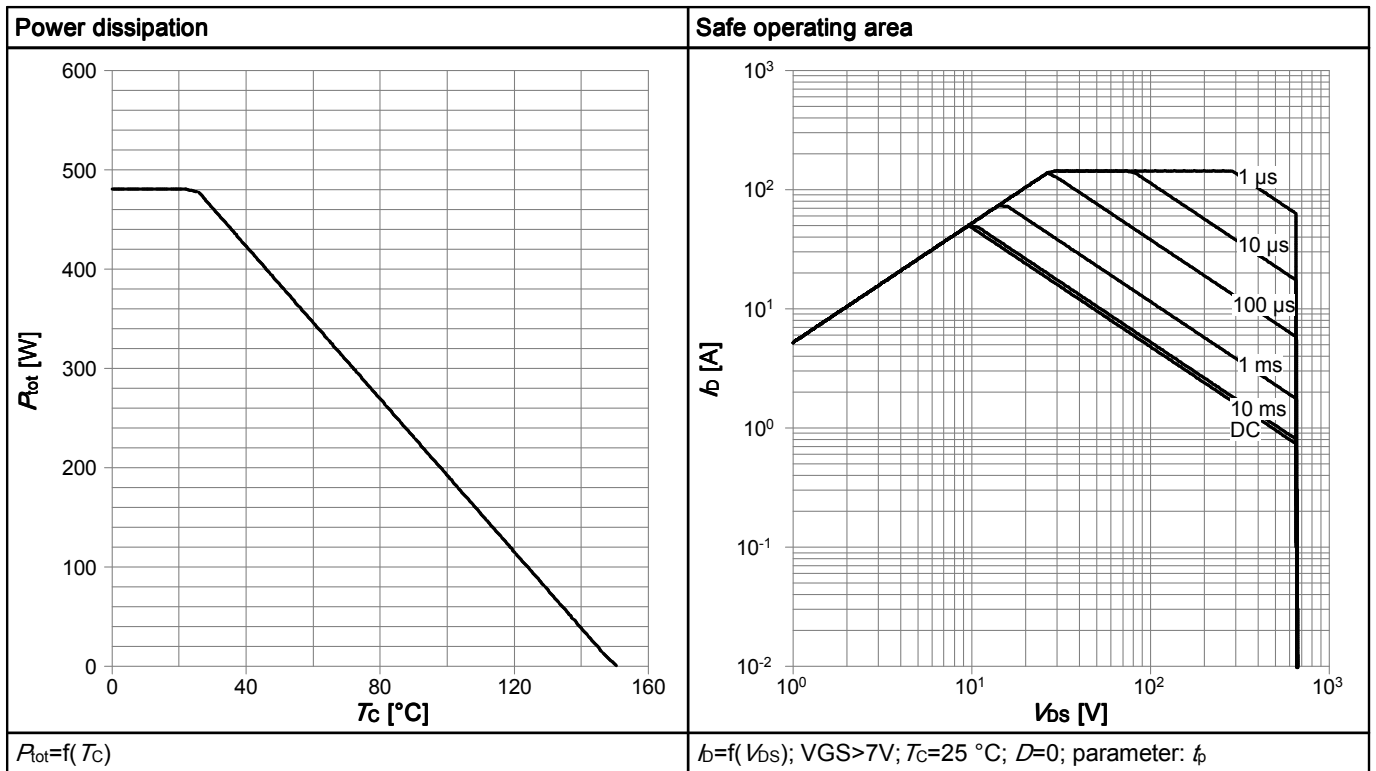
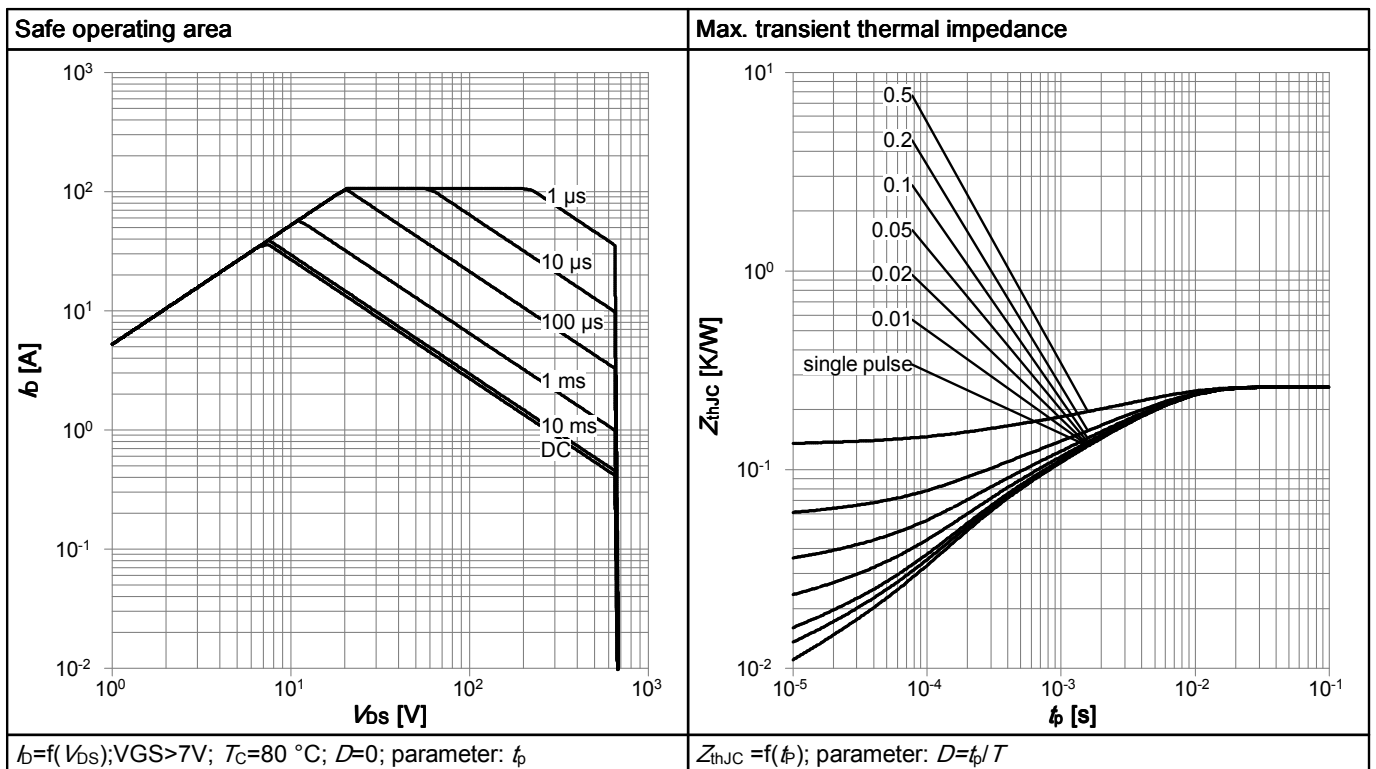

Table 9





650V CoolMOS™ C6 Power Transistor

IPP65R074C6

Table 10

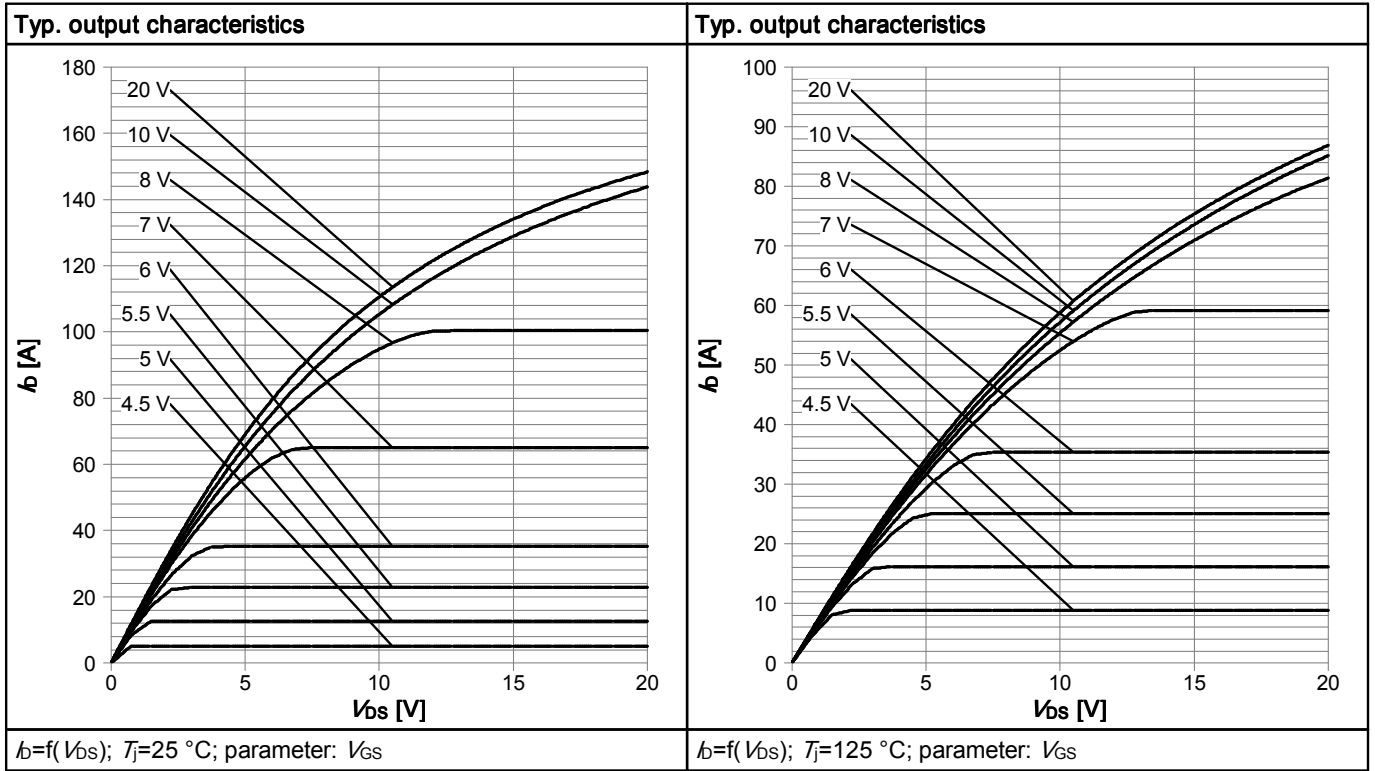
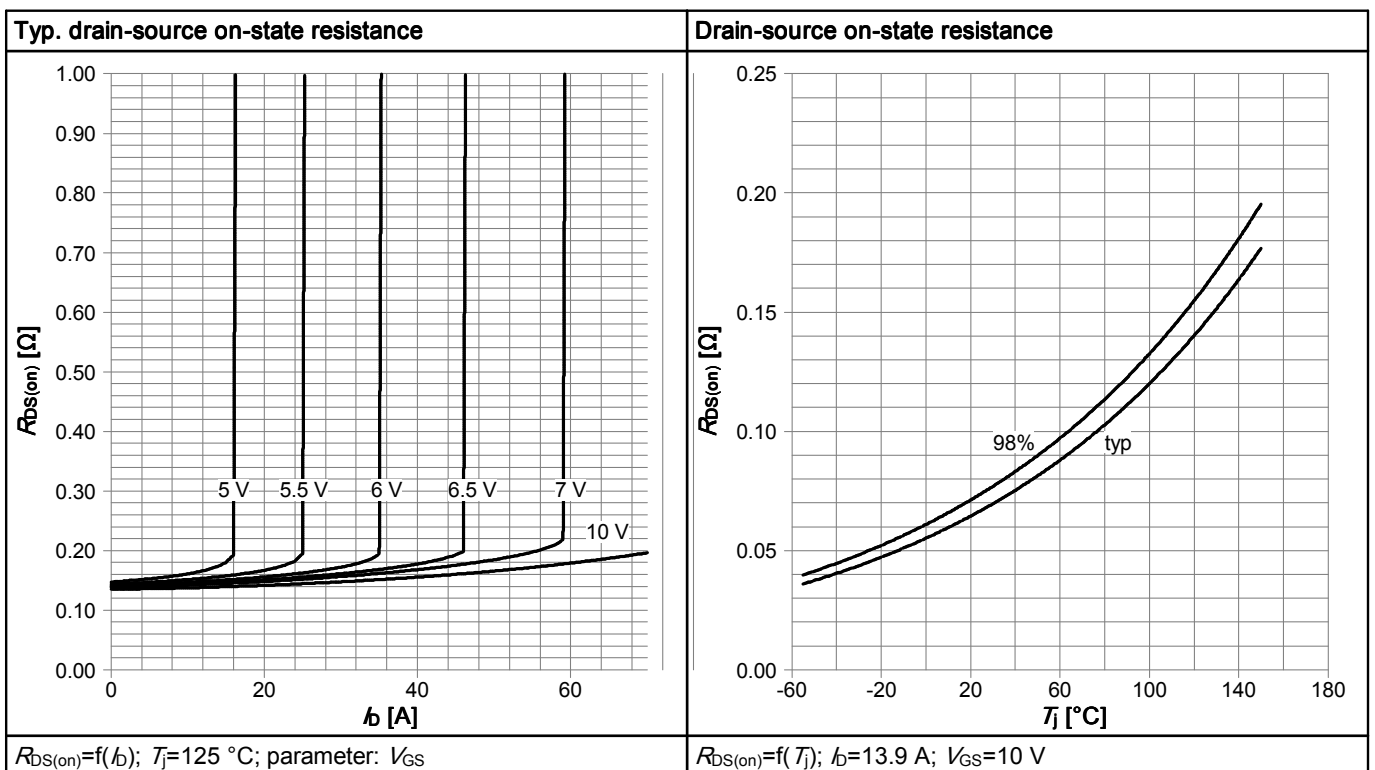

Table 11





650V CoolMOS™ C6 Power Transistor

IPP65R074C6

Table 12

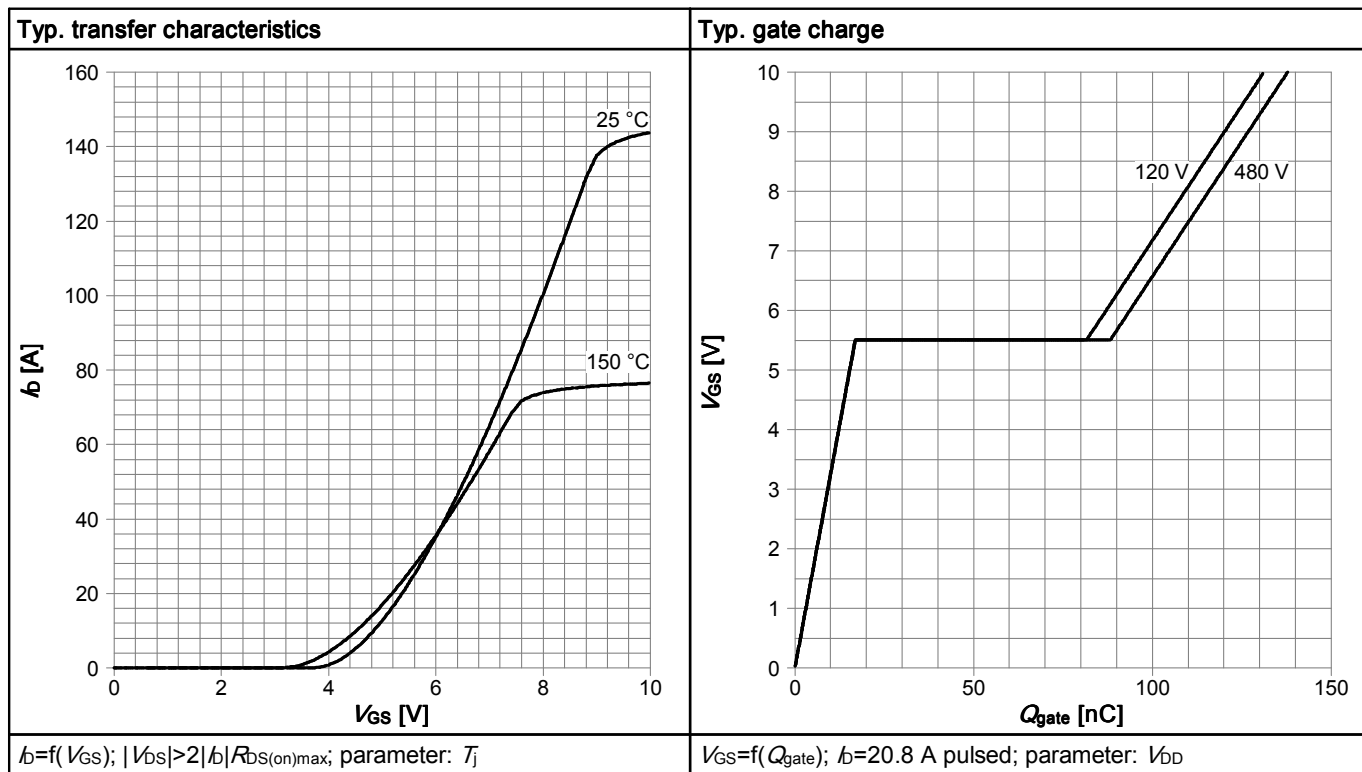
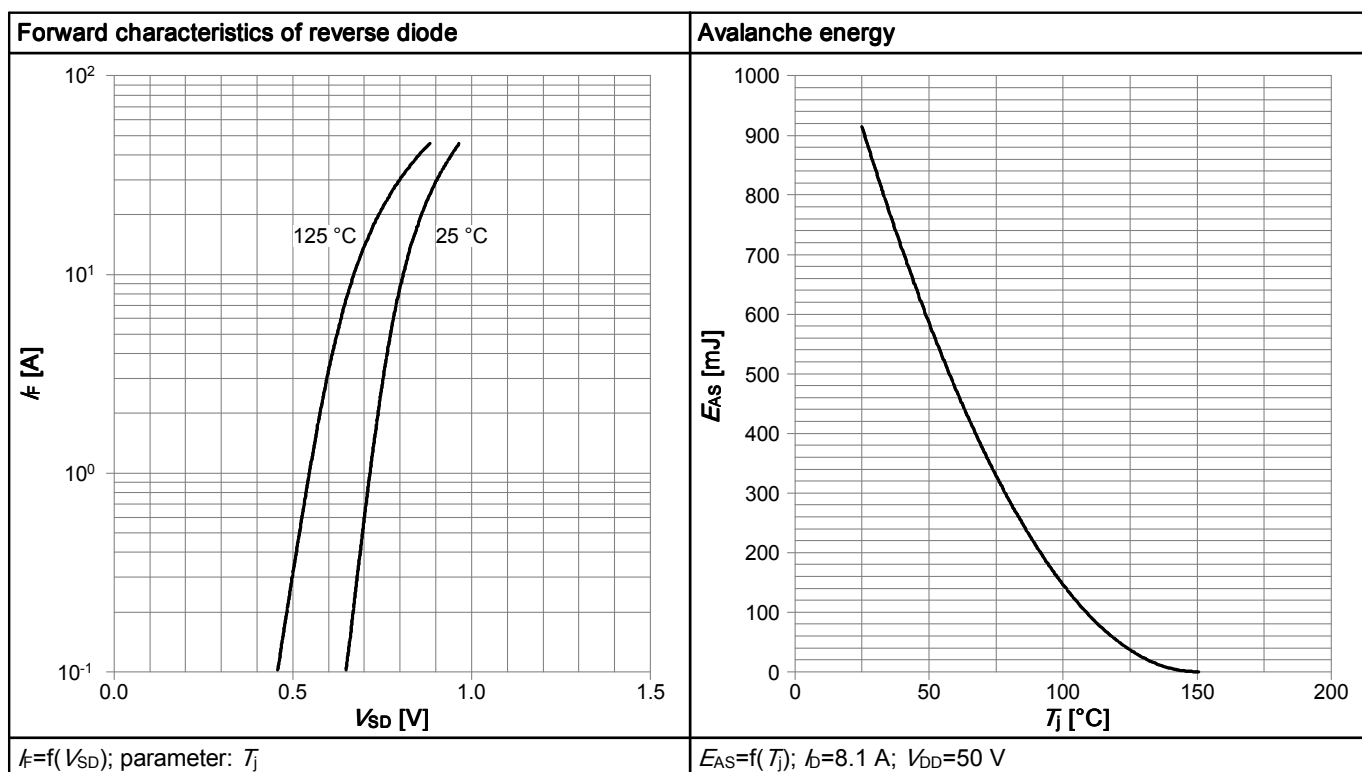

Table 13





650V CoolMOS™ C6 Power Transistor

IPP65R074C6

Table 14

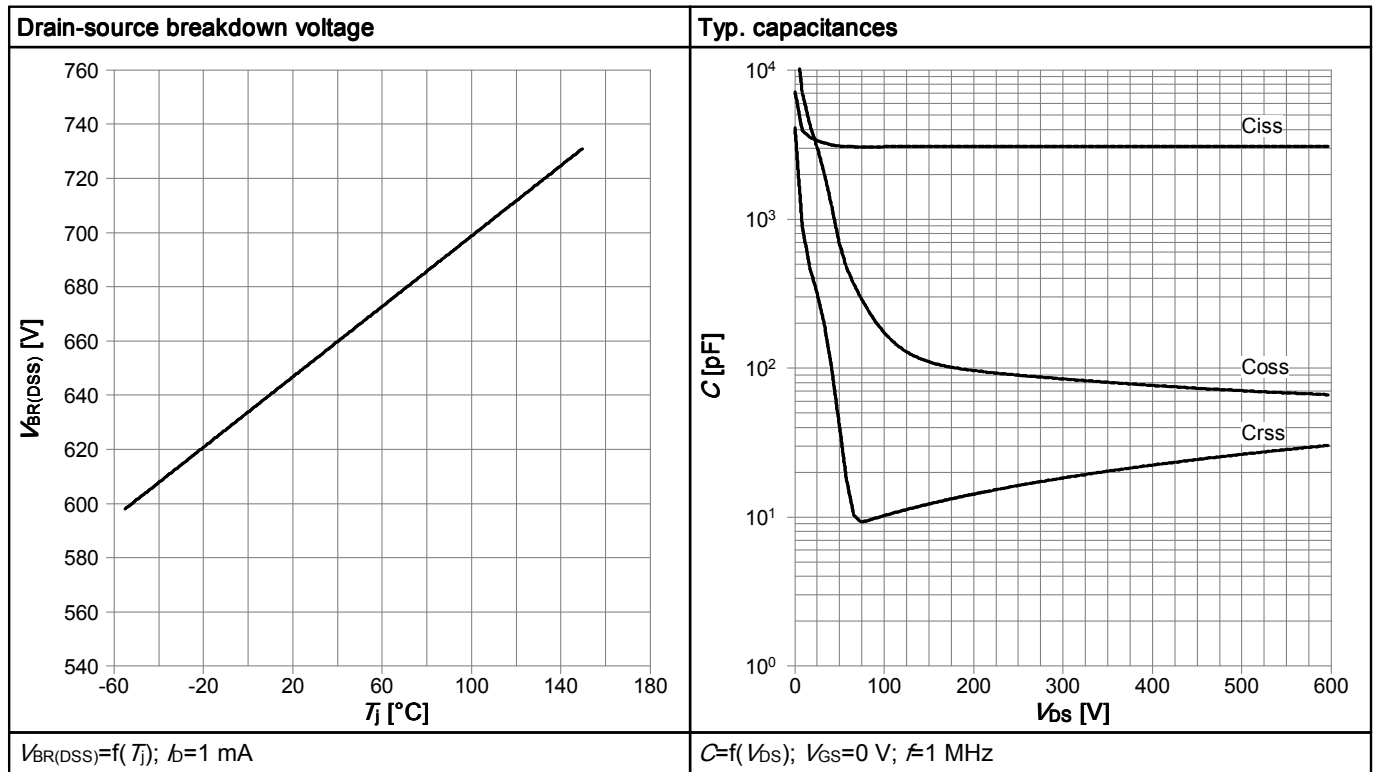
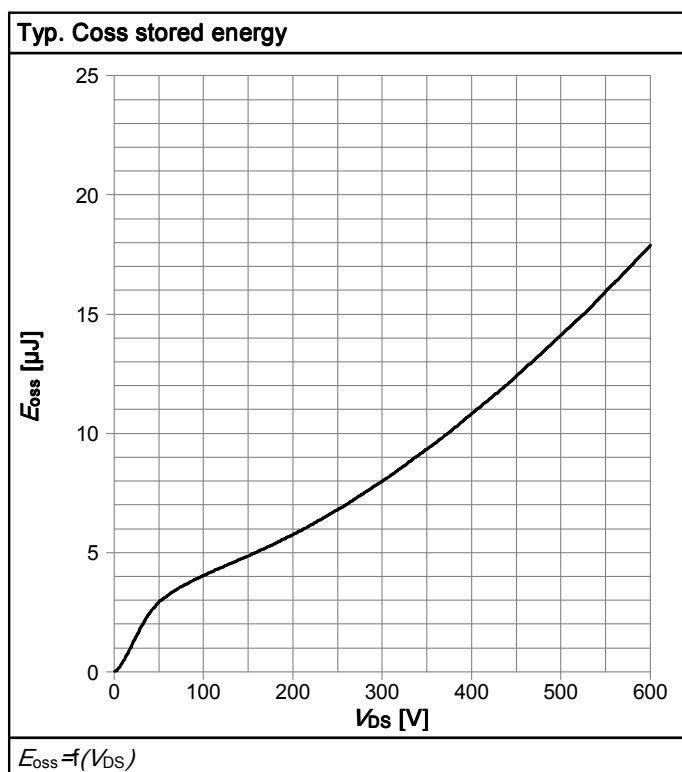

Table 15





**6 Test Circuits**

**Table 16 Diode\_characteristics**

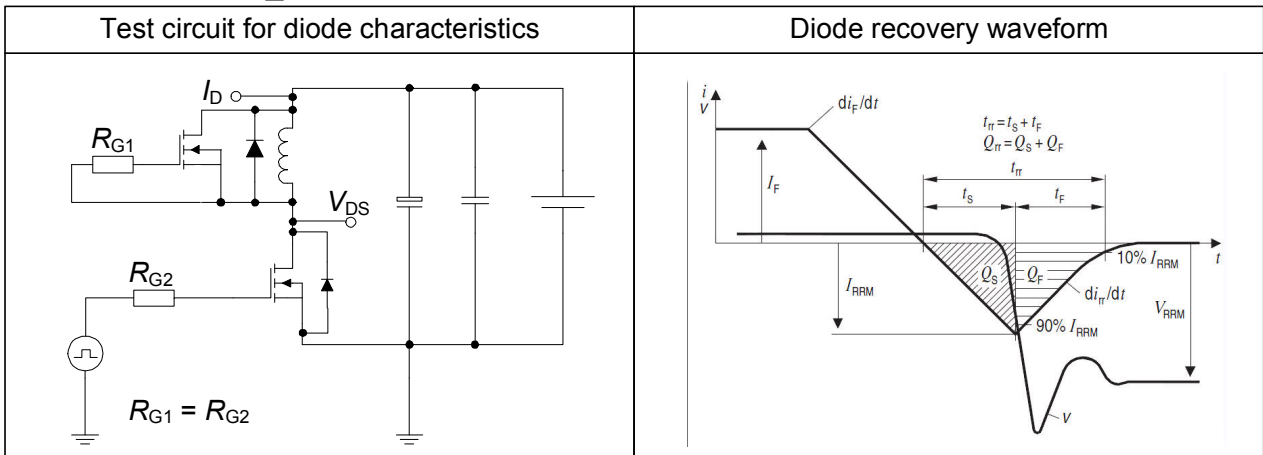

**Table 17 Switching\_times**

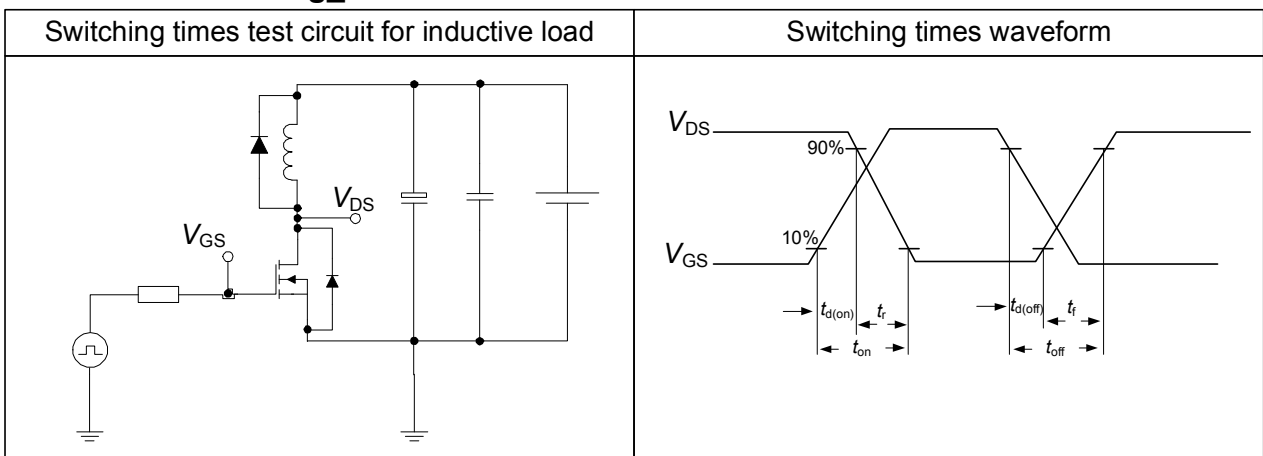

**Table 18 Unclamped\_inductive**

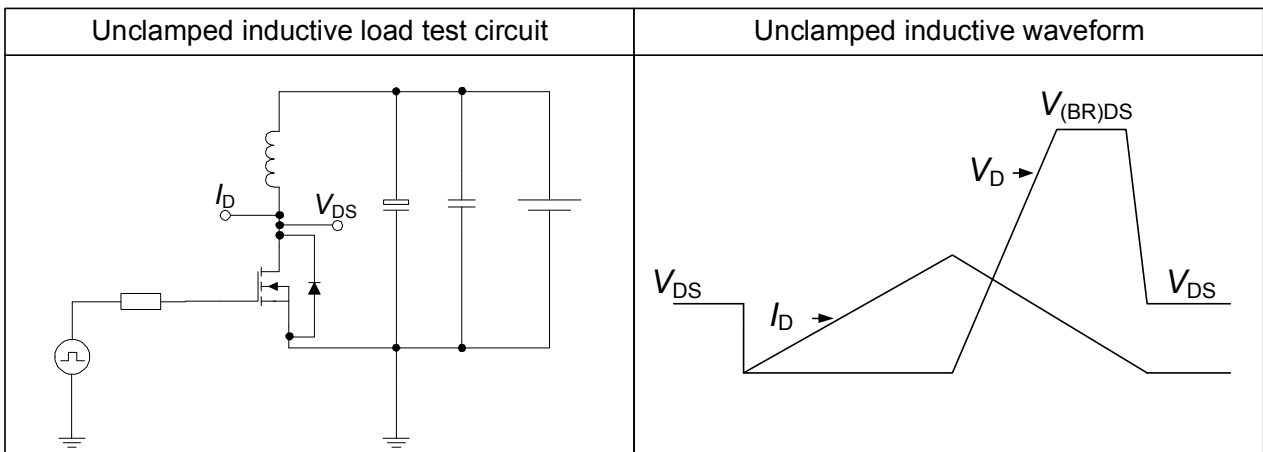



650V CoolMOS™ C6 Power Transistor

IPP65R074C6

7 Package Outlines

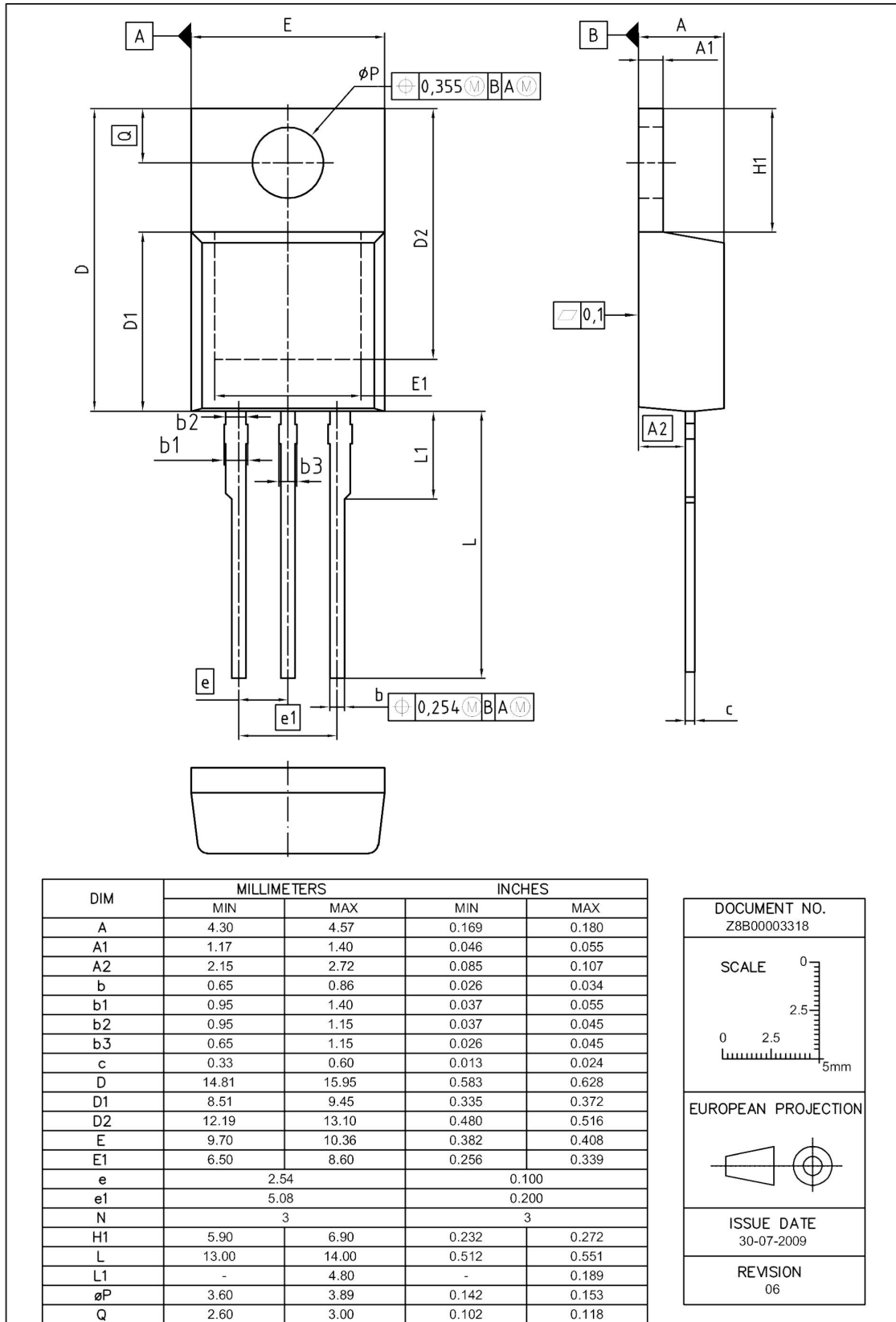

Figure 1 Outline PG-TO 220, dimensions in mm/inches



650V CoolMOS™ C6 Power Transistor

IPP65R074C6

---

## 8 Appendix A

### Table 19 Related Links

- **IFX C6 Product Brief:**

<http://www.infineon.com/dgdl/Product+Brief+600V+CoolMOS+C6+.pdf?folderId=db3a3043156fd5730115939eb6b506db>

- **IFX C6 Portfolio:**

[http://www.infineon.com/cms/en/product/findProductTypeByName.html?q=ip\\*c6](http://www.infineon.com/cms/en/product/findProductTypeByName.html?q=ip*c6)

- **IFX CoolMOS Webpage:**

<http://www.infineon.com/cms/en/product/channel.html?channel=ff80808112ab681d0112ab6a628704d8>

- **IFX Design Tools:**

<http://www.infineon.com/cms/en/product/promopages/designtools/index.html>



## Revision History

IPP65R074C6

**Revision: 2011-09-14, Rev. 2.1**

Previous Revision

Revision	Date	Subjects (major changes since last revision)
2.1	2011-09-14	Final Datasheet Release

### We Listen to Your Comments

Any information within this document that you feel is wrong, unclear or missing at all? Your feedback will help us to continuously improve the quality of this document. Please send your proposal (including a reference to this document) to: [erratum@infineon.com](mailto:erratum@infineon.com)

### Edition 2011-08-01

#### Published by

**Infineon Technologies AG****81726 München, Germany****© 2011 Infineon Technologies AG****All Rights Reserved.**

### Legal Disclaimer

The information given in this document shall in no event be regarded as a guarantee of conditions or characteristics. With respect to any examples or hints given herein, any typical values stated herein and/or any information regarding the application of the device, Infineon Technologies hereby disclaims any and all warranties and liabilities of any kind, including without limitation, warranties of non-infringement of intellectual property rights of any third party.

### Information

For further information on technology, delivery terms and conditions and prices please contact your nearest Infineon Technologies Office ([www.infineon.com](http://www.infineon.com)).

### Warnings

Due to technical requirements, components may contain dangerous substances. For information on the types in question, please contact the nearest Infineon Technologies Office.

The Infineon Technologies component described in this Data Sheet may be used in life-support devices or systems and/or automotive, aviation and aerospace applications or systems only with the express written approval of Infineon Technologies, if a failure of such components can reasonably be expected to cause the failure of that life-support, automotive, aviation and aerospace device or system or to affect the safety or effectiveness of that device or system. Life support devices or systems are intended to be implanted in the human body or to support and/or maintain and sustain and/or protect human life. If they fail, it is reasonable to assume that the health of the user or other persons may be endangered.