

Excellent Integrated System Limited

Stocking Distributor

Click to view price, real time Inventory, Delivery & Lifecycle Information:

[IXYS Corporation](#)

[DH60-14A](#)

For any questions, you can email us directly:

sales@integrated-circuit.com

Sonic Fast Recovery Diode

High Performance Fast Recovery Diode
 Low Loss and Soft Recovery
 Single Diode

Part number

DH60-14A

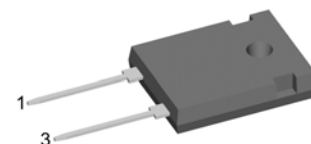
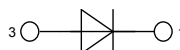

Backside: cathode

Features / Advantages:

- Planar passivated chips
- Very low leakage current
- Very short recovery time
- Improved thermal behaviour
- Very low I_{rm}-values
- Very soft recovery behaviour
- Avalanche voltage rated for reliable operation
- Soft reverse recovery for low EMI/RFI
- Low I_{rm} reduces:
 - Power dissipation within the diode
 - Turn-on loss in the commutating switch

Applications:

- Antiparallel diode for high frequency switching devices
- Antisaturation diode
- Snubber diode
- Free wheeling diode
- Rectifiers in switch mode power supplies (SMPS)
- Uninterruptible power supplies (UPS)

Package:

- Housing: TO-247
- Industry standard outline
- Epoxy meets UL 94V-0
- RoHS compliant

Ratings

Symbol	Definition	Conditions	Ratings			Unit
			min.	typ.	max.	
V _{RRM}	max. repetitive reverse voltage	T _{VJ} = 25 °C			1400	V
I _R	reverse current	V _R = 1400 V			200	μA
		V _R = 1400 V			2	mA
V _F	forward voltage	I _F = 60 A	T _{VJ} = 25 °C		2.04	V
					2.57	V
		I _F = 60 A	T _{VJ} = 125 °C		2.03	V
					2.73	V
I _{FAV}	average forward current	rectangular d = 0.5	T _C = 100 °C		60	A
V _{F0}	threshold voltage	} for power loss calculation only	T _{VJ} = 150 °C		1.28	V
r _F	slope resistance				12	mΩ
R _{thJC}	thermal resistance junction to case				0.30	K/W
T _{VJ}	virtual junction temperature		-55		150	°C
P _{tot}	total power dissipation		T _C = 25 °C		415	W
I _{FSM}	max. forward surge current	t = 10 ms (50 Hz), sine	T _{VJ} = 45 °C		700	A
I _{RM}	max. reverse recovery current	I _F = 60 A; V _R = 1200 V	T _{VJ} = 25 °C		60	A
			T _{VJ} = 100 °C		70	A
t _{rr}	reverse recovery time	-di _F /dt = 800 A/μs	T _{VJ} = 25 °C		230	ns
			T _{VJ} = 100 °C		350	ns
C _J	junction capacitance	V _R = 1200 V; f = 1 MHz	T _{VJ} = 25 °C		32	pF

Symbol	Definition	Conditions	Ratings			Unit
			min.	typ.	max.	
I_{RMS}	RMS current	per terminal			70	A
R_{thCH}	thermal resistance case to heatsink			0.25		K/W
T_{stg}	storage temperature		-55		150	°C
Weight				6		g
M_D	mounting torque		0.8		1.2	Nm
F_C	mounting force with clip		20		120	N

Product Marking

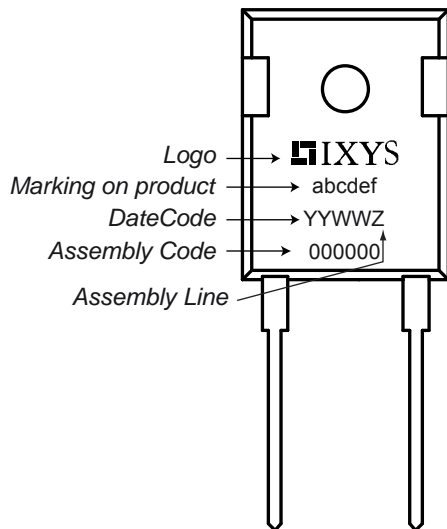

Ordering	Ordering Number	Marking on Product	Delivery Mode	Quantity	Code No.
Standard	DH60-14A	DH60-14A	Tube	30	496537

Similar Part	Package	Voltage Class
DH60-16A	TO-247AD (2)	1600
DH60-18A	TO-247AD (2)	1800

Outlines TO-247

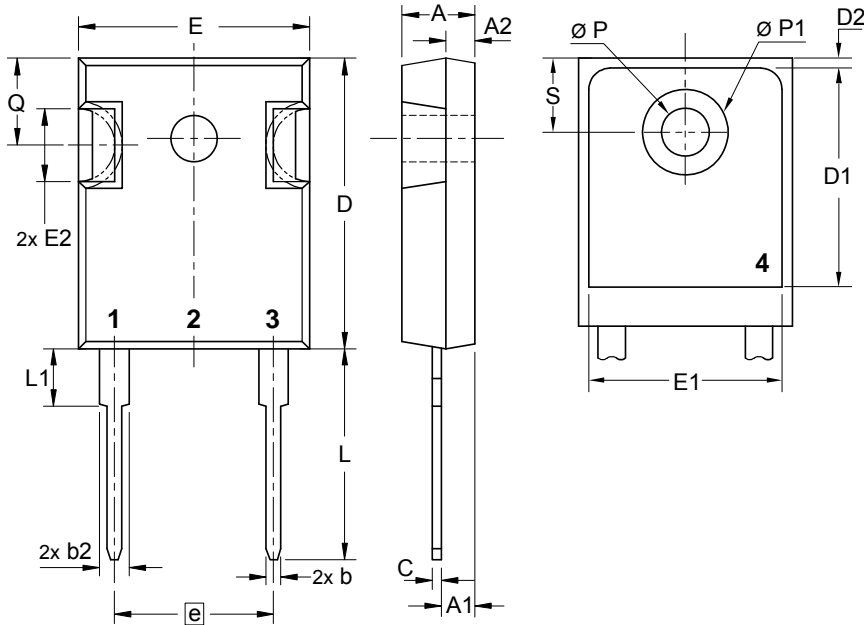

Sym.	Inches		Millimeter	
	min.	max.	min.	max.
A	0.185	0.209	4.70	5.30
A1	0.087	0.102	2.21	2.59
A2	0.059	0.098	1.50	2.49
D	0.819	0.845	20.79	21.45
E	0.610	0.640	15.48	16.24
E2	0.170	0.216	4.31	5.48
e	0.430 BSC		10.92 BSC	
L	0.780	0.800	19.80	20.30
L1	-	0.177	-	4.49
Ø P	0.140	0.144	3.55	3.65
Q	0.212	0.244	5.38	6.19
S	0.242 BSC		6.14 BSC	
b	0.039	0.055	0.99	1.40
b2	0.065	0.094	1.65	2.39
b4	0.102	0.135	2.59	3.43
c	0.015	0.035	0.38	0.89
D1	0.515	-	13.07	-
D2	0.020	0.053	0.51	1.35
E1	0.530	-	13.45	-
Ø P1	-	0.29	-	7.39

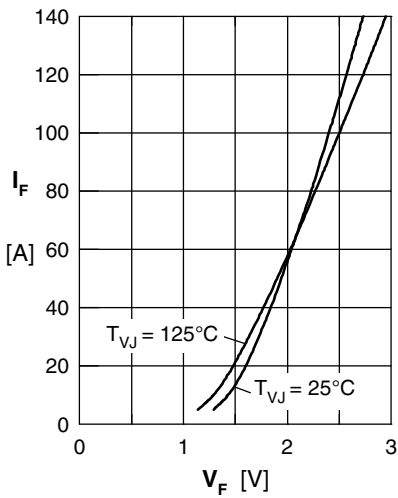

Fig. 1 Typ. rward current I_F versus V_F

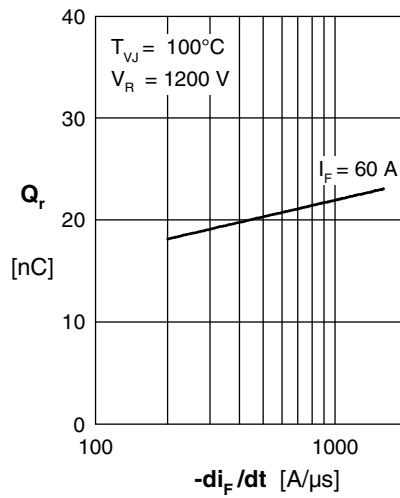

Fig. 2 Typ. reverse recovery charge Q_r versus $-di_F/dt$

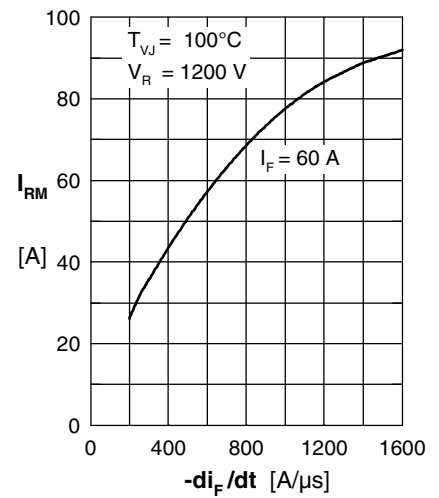

Fig. 3 Typ. peak reverse current I_{RM} versus $-di_F/dt$

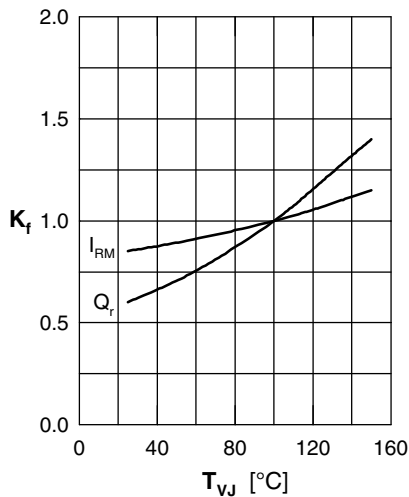

Fig. 4 Dynamic parameters Q_r , I_{RM} versus T_{VJ}

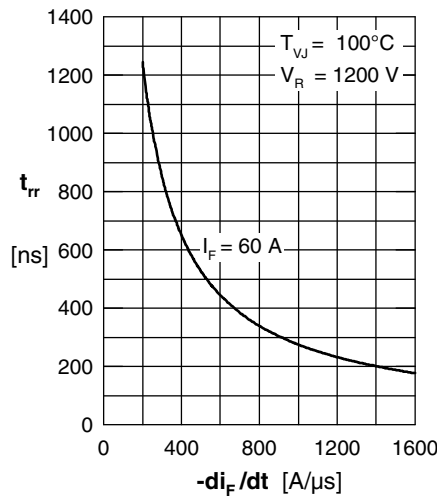

Fig. 5 Typ. recovery time t_{rr} versus $-di_F/dt$

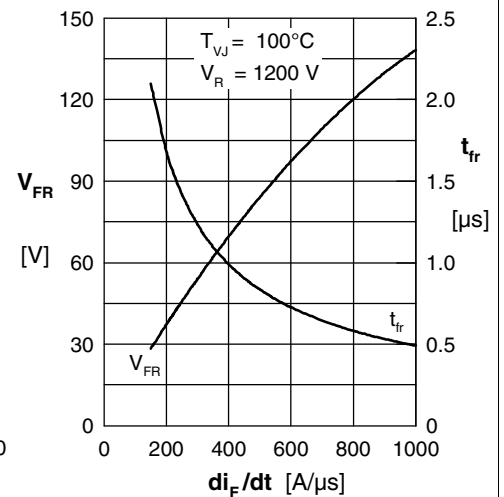

Fig. 6 Typ. peak forward voltage V_{FR} & typ. forward recovery time t_{fr} versus di_F/dt

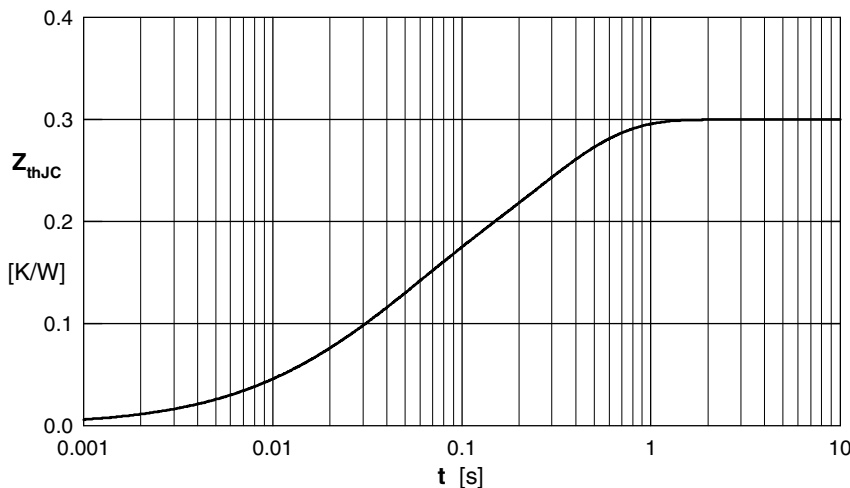

Fig. 7 Transient thermal resistance junction to case

i	R_i	\square
1	0.021	0.0093
2	0.11	0.038
3	0.169	0.274