

## Excellent Integrated System Limited

Stocking Distributor

Click to view price, real time Inventory, Delivery & Lifecycle Information:

[Harting](#)  
[09620640581](#)

For any questions, you can email us directly:  
[sales@integrated-circuit.com](mailto:sales@integrated-circuit.com)

Alle Rechte vorbehalten/ All rights reserved

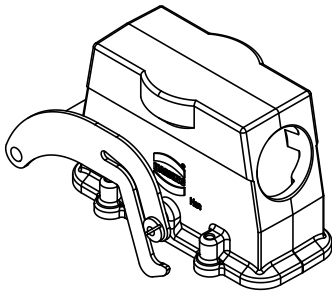
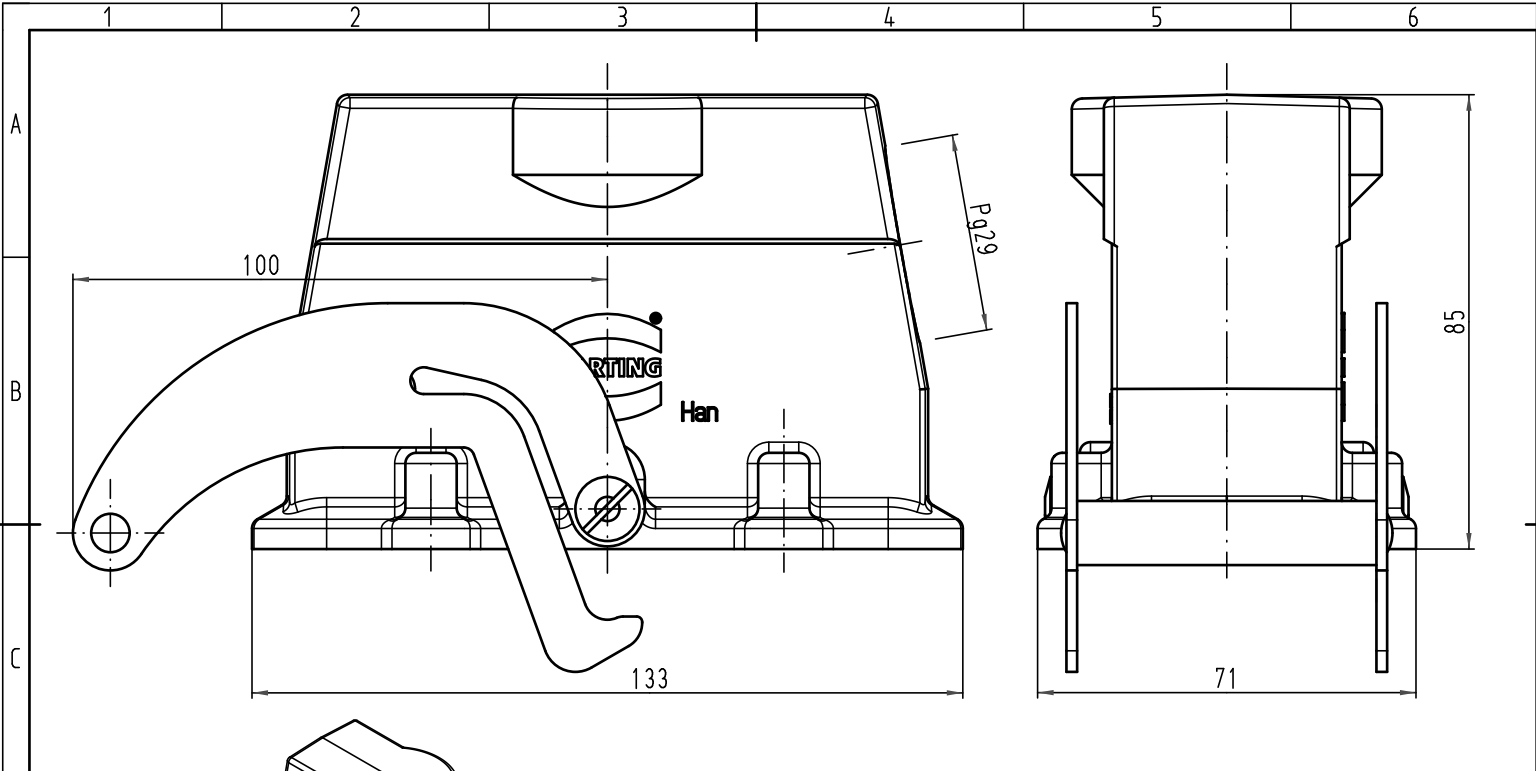

All Dimensions in mm Original Size DIN A 4			Techn. Character.			Nicht tolerierte Maß/Free size tolerances			
						<b>Han 64EMV-gs-ZV-29</b> Tüllengehäuse hood			
			Detail.	04.02.11	gru				Maßstab/Scale <b>1:1</b>
			Insp.		Tie				
			Stand.						
A			HARTING Electric GmbH & Co. KG				<b>TB 09 62 064 0581</b>		Blatt/ page
Mod.	Dat.	Name	D-32339 Espelkamp				Sub. TB 09 62 064 0581 v. 14.08.01		