

Excellent Integrated System Limited

Stocking Distributor

Click to view price, real time Inventory, Delivery & Lifecycle Information:

[BUD Industries, Inc.](#)
[NHC-14150](#)

For any questions, you can email us directly:

sales@integrated-circuit.com

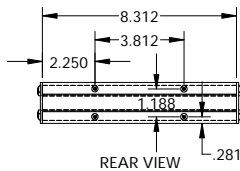

REAR VIEW

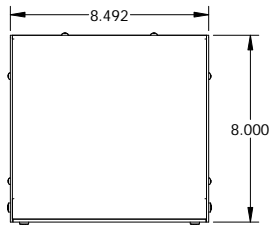

TOP VIEW

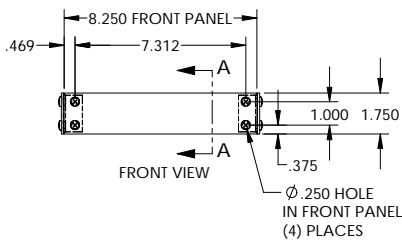

FRONT VIEW

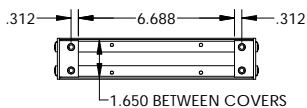

FRONT VIEW (LESS FRONT PANEL)

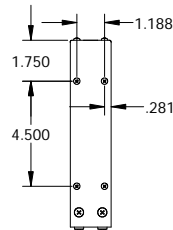

SIDE VIEW

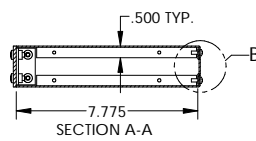

SECTION A-A

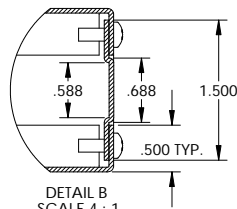

DETAIL B SCALE 4 : 1

UNIT SHIPPED UNASSEMBLED.
 OPTIONAL SELF-ADHESIVE RUBBER FEET (SUPPLIED)
 LOAD RATING: 25 LBS. MAX.

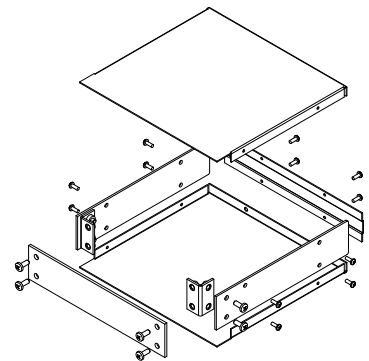

MATERIAL:

- BACK & COVERS _____ 0.050 THICK ALUMINUM
- SIDES & INNER BRACKETS _____ 0.090 THICK ALUMINUM
- FRONT PANEL _____ 0.125 THICK ALUMINUM

FINISH:

- BACK & COVERS _____ PREPAINTED SMOOTH WHITE
- SIDES _____ WHITE TEXTURED
- FRONT PANEL _____ NATURAL (OUTSIDE SURFACE TAPED WITH PVC)
- INNER BRACKETS _____ NATURAL
- FEET _____ BLACK