

Excellent Integrated System Limited

Stocking Distributor

Click to view price, real time Inventory, Delivery & Lifecycle Information:

[Vishay Semiconductor/Diodes Division](#)
[MBRS340TR](#)

For any questions, you can email us directly:

sales@integrated-circuit.com

International IOR Rectifier

MBRS340TR

SCHOTTKY RECTIFIER

3 Amp

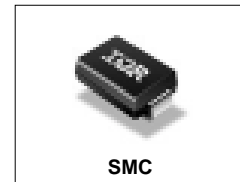

Major Ratings and Characteristics

Characteristics	Value	Units
$I_{F(AV)}$ Rectangular waveform	3.0	A
V_{RRM}	40	V
I_{FSM} @ $t_p=5\mu s$ sine	1580	A
V_F @ 3.0Apk, $T_J=125^\circ C$	0.43	V
T_J range	- 55 to 150	$^\circ C$

Description/ Features

The MBRS340TR surface-mount Schottky rectifier has been designed for applications requiring low forward drop and small foot prints on PC boards. Typical applications are in disk drives, switching power supplies, converters, free-wheeling diodes, battery charging, and reverse battery protection.

- Small foot print, surface mountable
- Very low forward voltage drop
- High frequency operation
- Guard ring for enhanced ruggedness and long term reliability

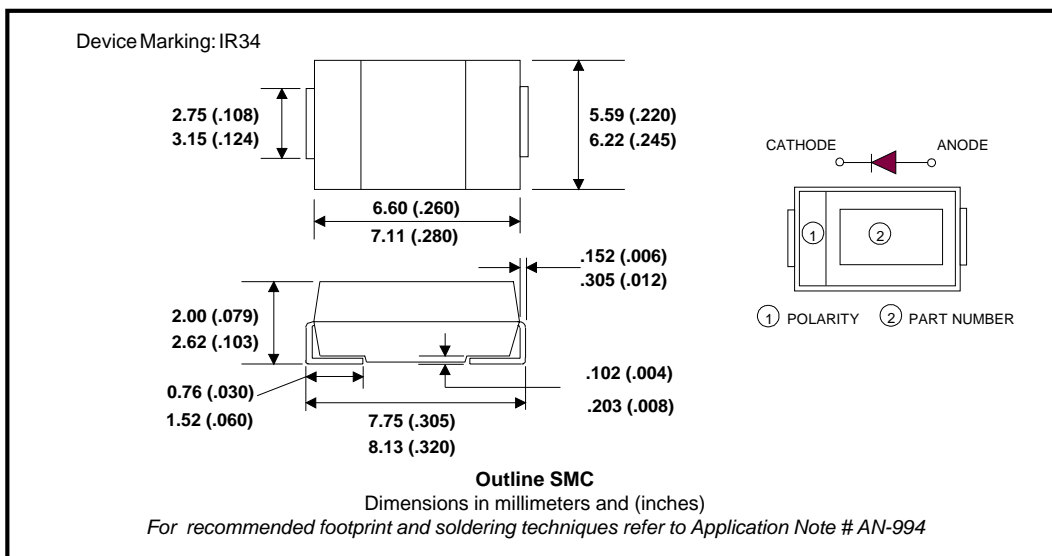

MBRS340TR

Bulletin PD-20585 rev. D 03/03

 International
IR Rectifier

Voltage Ratings

Part number	MBRS340TR
V _R Max. DC Reverse Voltage (V)	40
V _{RWM} Max. Working Peak Reverse Voltage (V)	

Absolute Maximum Ratings

Parameters	Value	Units	Conditions
I _{F(AV)} Max. Average Forward Current	3.0	A	50% duty cycle @ T _L = 118 °C, rectangular wave form
	4.0		50% duty cycle @ T _L = 110 °C, rectangular waveform
I _{FSM} Max. Peak One Cycle Non-Repetitive Surge Current	1580	A	5µs Sine or 3µs Rect. pulse
	80		10ms Sine or 6ms Rect. pulse
E _{AS} Non Repetitive Avalanche Energy	6	mJ	T _J = 25 °C, I _{AS} = 1.0A, L = 12mH
I _{AR} Repetitive Avalanche Current	1.0	A	Current decaying linearly to zero in 1 µsec Frequency limited by T _J max. Va = 1.5 x Vr typical

Electrical Specifications

Parameters	Value	Units	Conditions
V _{FM} Max. Forward Voltage Drop (1)	0.525	V	@ 3A
	0.68	V	@ 6A
	0.43	V	@ 3A
	0.57	V	@ 6A
I _{RM} Max. Reverse Leakage Current	2.0	mA	T _J = 25 °C
	20	mA	T _J = 100 °C
	35	mA	T _J = 125 °C
C _T Max. Junction Capacitance	230	pF	V _R = 5V _{DC} (test signal range 100KHz to 1Mhz) 25 °C
L _S Typical Series Inductance	3.0	nH	Measured lead to lead 5mm from package body
dv/dt Max. Voltage Rate of Change	10000	V/µs	(Rated V _R)

(1) Pulse Width < 300µs, Duty Cycle < 2%

Thermal-Mechanical Specifications

Parameters	Value	Units	Conditions
T _J Max. Junction Temperature Range (*)	-55 to 150	°C	
T _{stg} Max. Storage Temperature Range	-55 to 150	°C	
R _{thJL} Max. Thermal Resistance Junction to Lead (**)	12	°C/W	DC operation
R _{thJA} Max. Thermal Resistance Junction to Ambient	46	°C/W	DC operation
wt Approximate Weight	0.24(0.008)	g(oz.)	
Case Style	SMC		Similar to DO-214AB
Device Marking	IR34		

 (*) $\frac{dP_{tot}}{dT_J} < \frac{1}{R_{th(j-a)}}$ thermal runaway condition for a diode on its own heatsink

(**) Mounted 1 inch square PCB

International
IOR Rectifier

MBR340TR

Bulletin PD-20585 rev. D 03/03

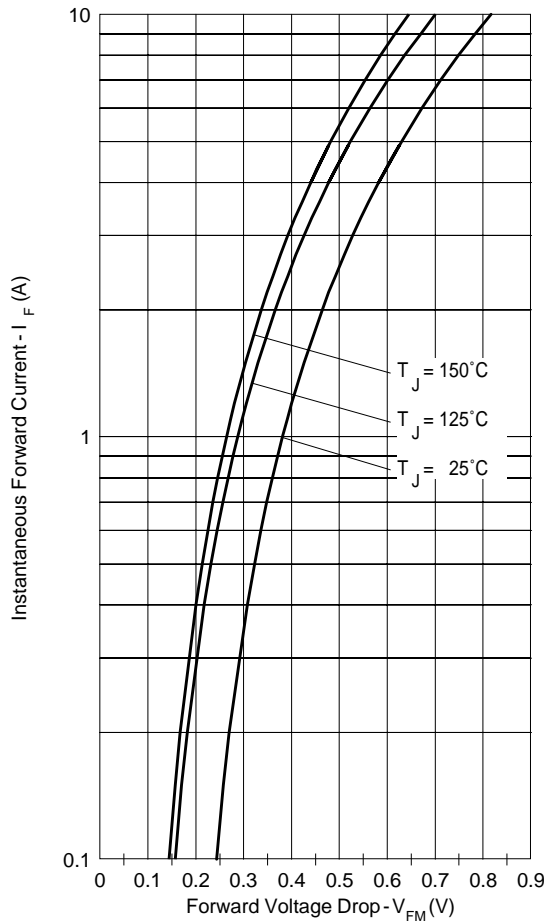

Fig. 1 - Max. Forward Voltage Drop Characteristics (Per Leg)

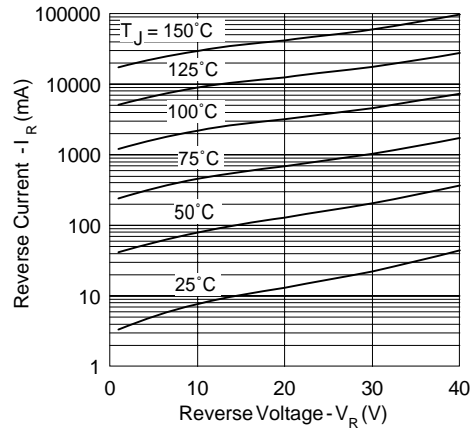

Fig. 2 - Typical Values Of Reverse Current Vs. Reverse Voltage (Per Leg)

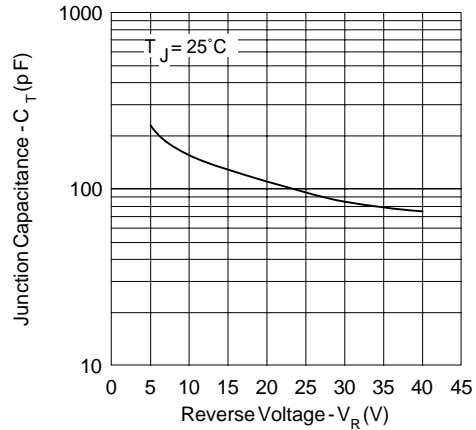

Fig. 3 - Typical Junction Capacitance Vs. Reverse Voltage (Per Leg)

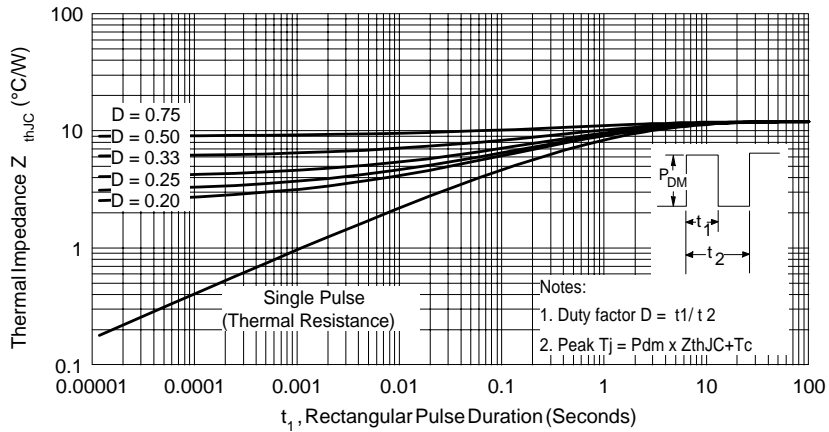

Fig. 4 - Max. Thermal Impedance Z_{thJC} Characteristics (Per Leg)

MBRS340TR

Bulletin PD-20585 rev. D 03/03

International
IRF Rectifier

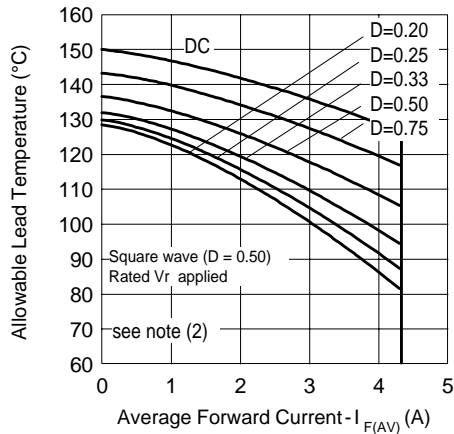

Fig. 4 - Maximum Average Forward Current Vs. Allowable Lead Temperature

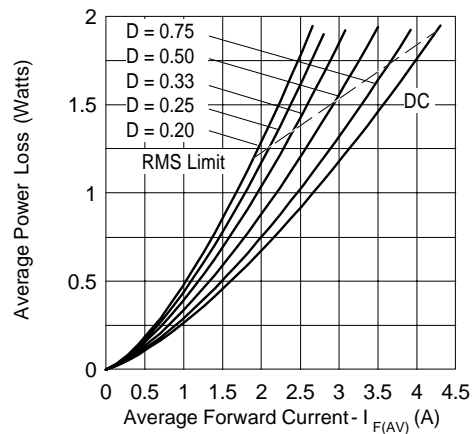

Fig. 5 - Maximum Average Forward Dissipation Vs. Average Forward Current

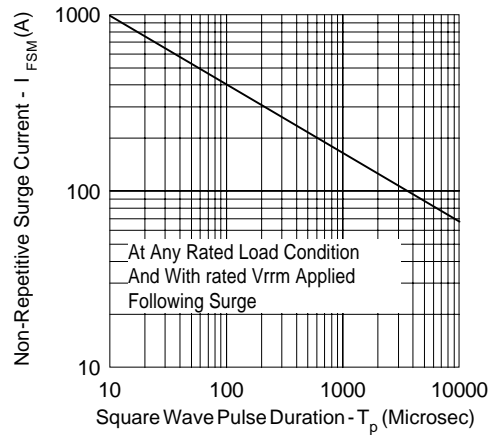

Fig. 6 - Maximum Peak Surge Forward Current Vs. Pulse Duration

- (2) Formula used: $T_C = T_J - (Pd + Pd_{REV}) \times R_{thJC}$;
 Pd = Forward Power Loss = $I_{F(AV)} \times V_{FM} @ (I_{F(AV)}/D)$ (see Fig. 6);
 Pd_{REV} = Inverse Power Loss = $V_{R1} \times I_R (1 - D)$; $I_R @ V_{R1} = 80\%$ rated V_R

International
IR Rectifier

MBRS340TR

Bulletin PD-20585 rev. D 03/03

Tape & Reel Information

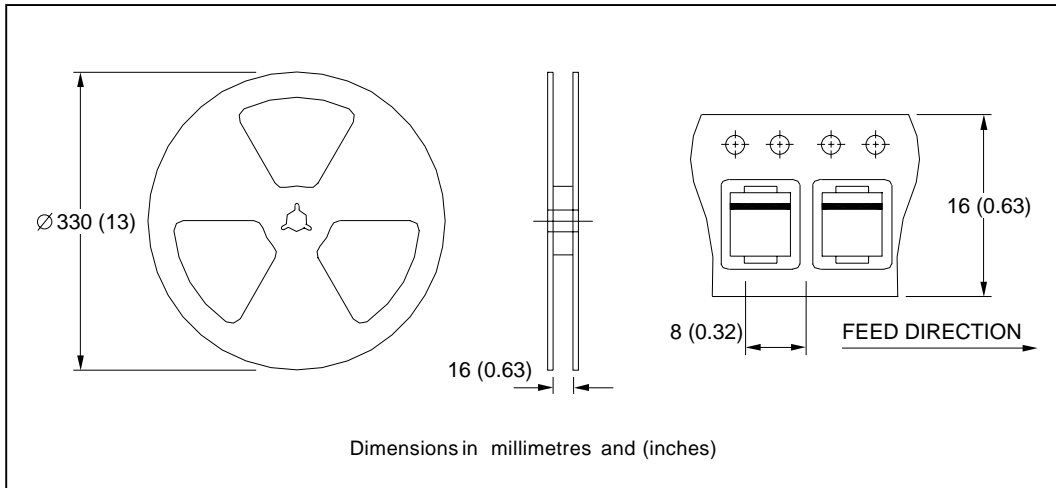

Marking & Identification

Each device has 2 rows for identification. The first row designates the device as manufactured by International Rectifier as indicated by the letters "IR", and the Part Number (indicates the current and the voltage rating). The second row indicates the year, the week of manufacturing and the Site ID.

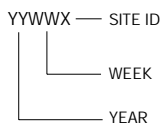
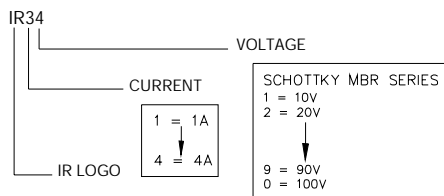

Ordering Information

MBRS340TR - TAPE AND REEL

WHEN ORDERING, INDICATE THE PART NUMBER AND THE QUANTITY (IN MULTIPLES OF 3000 PIECES).

EXAMPLE: MBRS340TR - 6000 PIECES

MBRS340TR

Bulletin PD-20585 rev. D 03/03

International
IOR Rectifier

Data and specifications subject to change without notice.
This product has been designed and qualified for Industrial Level.
Qualification Standards can be found on IR's Web site.

International
IOR Rectifier

IR WORLD HEADQUARTERS: 233 Kansas St., El Segundo, California 90245, USA Tel: (310) 252-7105
TAC Fax: (310) 252-7309
Visit us at www.irf.com for sales contact information. 03/03