

Excellent Integrated System Limited

Stocking Distributor

Click to view price, real time Inventory, Delivery & Lifecycle Information:

[Vishay Semiconductor/Diodes Division](#)
[MBRA140TR](#)

For any questions, you can email us directly:

sales@integrated-circuit.com

International IOR Rectifier

MBRA140TR

SCHOTTKY RECTIFIER

1.0 Amp

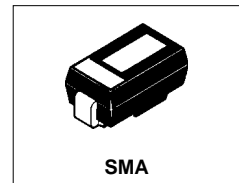

Major Ratings and Characteristics

Characteristics	MBRA140TR	Units
I_{FAV} Rect. Waveform	1.0	A
V_{RRM}	40	V
I_{FSM} @ $t_p = 5 \mu s$ sine	120	A
V_F @ 1.0Apk, $T_J = 125^\circ C$	0.49	V
T_J range	- 55 to 150	$^\circ C$

Description/ Features

The MBRA140TR surface mount Schottky rectifier has been designed for applications requiring low forward drop and very small foot prints on PC boards. Typical applications are in disk drives, switching power supplies, converters, free-wheeling diodes, battery charging, and reverse battery protection.

- Small foot print, surface mountable
- Low forward voltage drop
- High frequency operation
- Guard ring for enhanced ruggedness and long term reliability

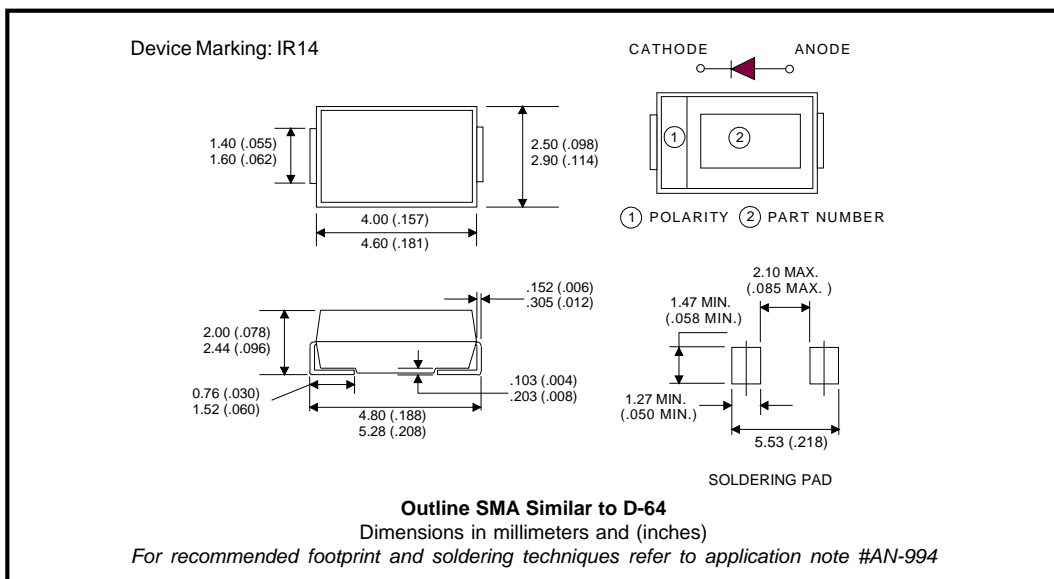

MBRA140TR

Bulletin PD-20582 rev. C 03/03

 International

Voltage Ratings

Part number	MBRA140TR
V_R Max. DC Reverse Voltage (V)	40
V_{RWM} Max. Working Peak Reverse Voltage (V)	

Absolute Maximum Ratings

Parameters	Value	Units	Conditions
$I_{F(AV)}$ Max. Average Forward Current * See Fig. 4	1.0	A	50% duty cycle @ $T_L = 118^\circ\text{C}$, rectangular wave form. On PC board 9mm ² island (.013mm thick copper pad area)
I_{FSM} Max. Peak One Cycle Non-Repetitive Surge Current * See Fig. 6	120	A	Following any rated load condition and with rated V_{RWM} applied
	30		
E_{AS} Non-Repetitive Avalanche Energy	3.0	mJ	$T_J = 25^\circ\text{C}$, $I_{AS} = 1\text{A}$, $L = 6\text{mH}$
I_{AR} Repetitive Avalanche Current	1.0	A	

Electrical Specifications

Parameters	Value	Units	Conditions
V_{FM} Max. Forward Voltage Drop (1) * See Fig. 1	0.55	V	@ 1A
	0.71	V	@ 2A
	0.5	V	@ 1A
	0.65	V	@ 2A
	0.49	V	@ 1A
	0.63	V	@ 2A
I_{RM} Max. Reverse Leakage Current (1) * See Fig. 2	0.5	mA	$T_J = 25^\circ\text{C}$
	10	mA	$T_J = 100^\circ\text{C}$
	26	mA	$T_J = 125^\circ\text{C}$
$V_{F(TO)}$ Threshold Voltage	0.36	V	$T_J = T_J \text{ max.}$
r_t Forward Slope Resistance	104	m Ω	
C_T Typical Junction Capacitance	38	pF	$V_R = 10V_{DC}$, $T_J = 25^\circ\text{C}$, test signal = 1Mhz
L_S Typical Series Inductance	2.0	nH	Measured lead to lead 5mm from package body
dv/dt Max. Voltage Rate of Change	10000	V/ μs	(Rated V_R)

 (1) Pulse Width < 300 μs , Duty Cycle < 2%

Thermal-Mechanical Specifications

Parameters	Value	Units	Conditions
T _J Max. Junction Temperature Range (*)	-55 to 150	°C	
T _{stg} Max. Storage Temperature Range	-55 to 150	°C	
R _{thJL} Max. Thermal Resistance Junction to Lead (**)	35	°C/W	DC operation (* See Fig. 4)
R _{thJA} Max. Thermal Resistance Junction to Ambient	80	°C/W	DC operation
wt Approximate Weight	0.07(0.002)	g (oz.)	
Case Style	SMA		Similar D-64
Device Marking	IR14		

(*) $\frac{dP_{tot}}{dT_j} < \frac{1}{R_{th(j-a)}}$ thermal runaway condition for a diode on its own heatsink

(**) Mounted 1 inch square PCB, Thermal Probe connected to lead 2mm from Package

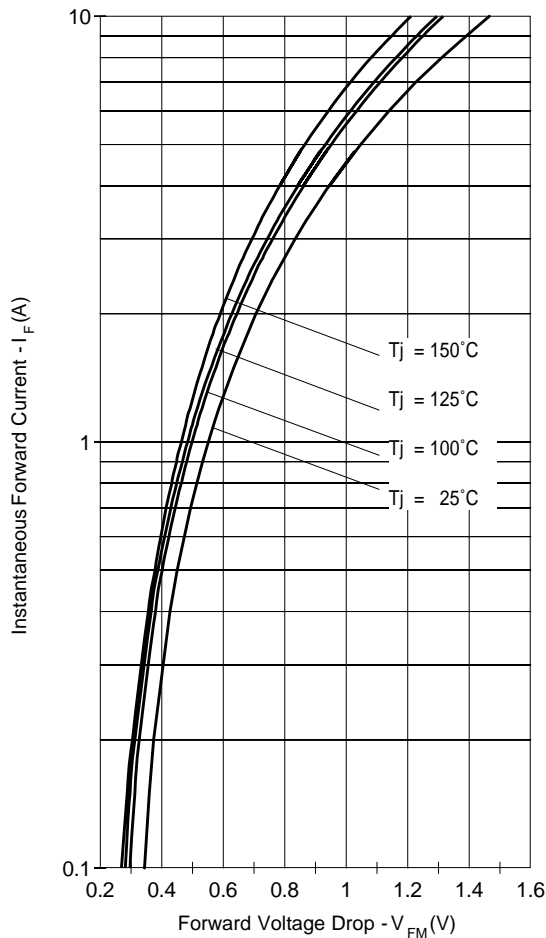

Fig. 1 - Maximum Forward Voltage Drop Characteristics

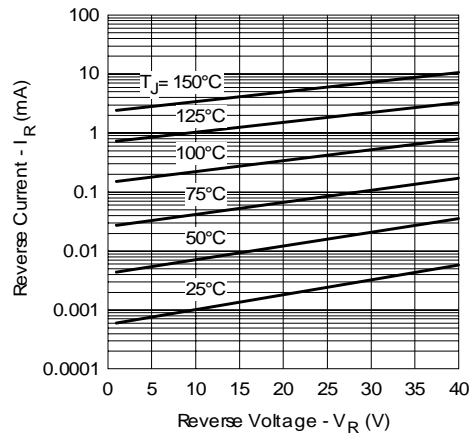

Fig. 2 - Typical Peak Reverse Current Vs. Reverse Voltage

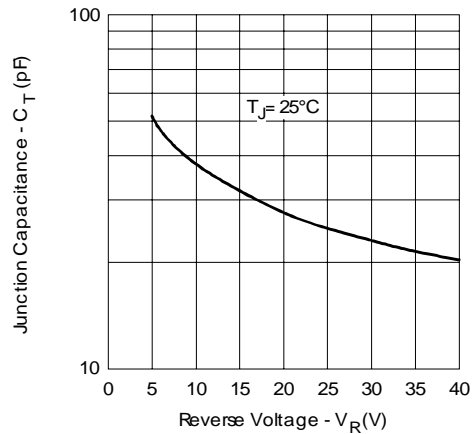

Fig. 3 - Typical Junction Capacitance Vs. Reverse Voltage

MBRA140TR

Bulletin PD-20582 rev. C 03/03

International
IRF Rectifier

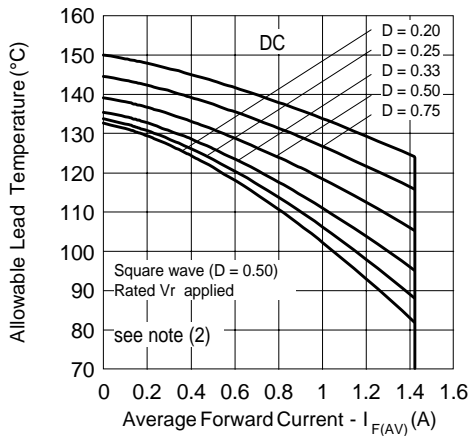

Fig. 4 - Maximum Average Forward Current Vs. Allowable Lead Temperature

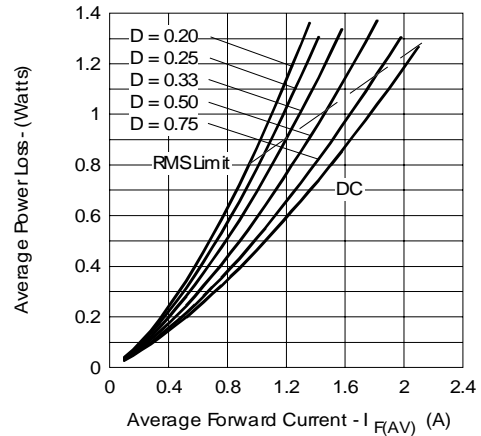

Fig. 5 - Maximum Average Forward Dissipation Vs. Average Forward Current

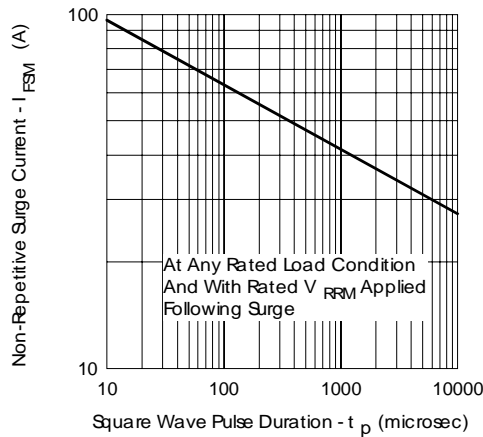

Fig. 6 - Maximum Peak Surge Forward Current Vs. Pulse Duration

- (2) Formula used: $T_c = T_j - (Pd + Pd_{REV}) \times R_{thJC}$;
 $Pd = \text{Forward Power Loss} = I_{F(AV)} \times V_{FM} @ (I_{F(AV)} / D)$ (see Fig. 6);
 $Pd_{REV} = \text{Inverse Power Loss} = V_{R1} \times I_R (1 - D)$; $I_R @ V_{R1} = 80\% \text{ rated } V_R$

International
IR Rectifier

MBRA140TR

Bulletin PD-20582 rev. C 03/03

Tape & Reel Information

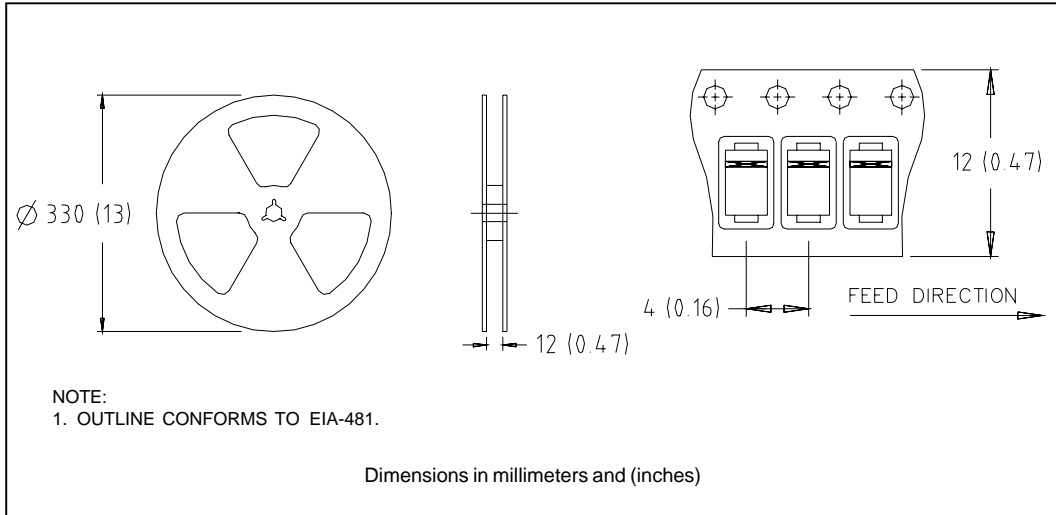

Marking & Identification

Each device has 2 rows for identification. The first row designates the device as manufactured by International Rectifier as indicated by the letters "IR", and the Part Number (indicates the current and the voltage rating). The second row indicates the year, the week of manufacturing and the Site ID.

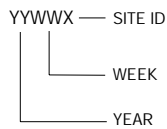
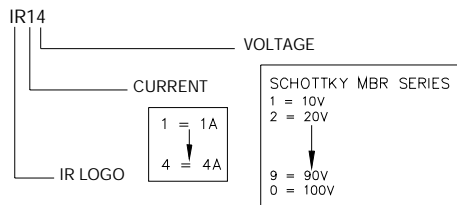
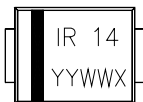

Ordering Information

MBRA140TR - TAPE AND REEL

WHEN ORDERING, INDICATE THE PART NUMBER AND THE QUANTITY (IN MULTIPLES OF 7500 PIECES).

EXAMPLE: MBRA140TR - 15000 PIECES

MBRA140TR

Bulletin PD-20582 rev. C 03/03

International
IR Rectifier

Data and specifications subject to change without notice.
This product has been designed and qualified for Industrial Level.
Qualification Standards can be found on IR's Web site.

International
IR Rectifier

IR WORLD HEADQUARTERS: 233 Kansas St., El Segundo, California 90245, USA Tel: (310) 252-7105
TAC Fax: (310) 252-7309

Visit us at www.irf.com for sales contact information. 03/03