

## Excellent Integrated System Limited

Stocking Distributor

Click to view price, real time Inventory, Delivery & Lifecycle Information:

[Molex Connector Corporation](#)  
[0395066010](#)

For any questions, you can email us directly:

[sales@integrated-circuit.com](mailto:sales@integrated-circuit.com)

10 9 8 7 6 5 4 3 2 39501

**3950X SERIES  
3.50mm HEADERS**

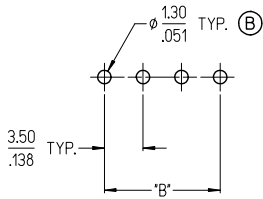

**3952X & 3954X SERIES  
5.00mm HEADERS  
5.00mm FIXED**

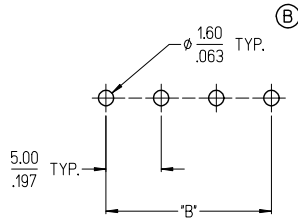

**3953X SERIES  
5.08mm HEADERS**

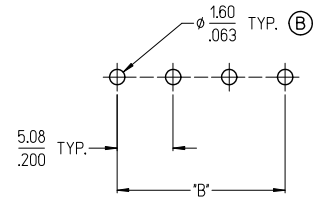

**3951X SERIES  
3.81mm HEADERS**

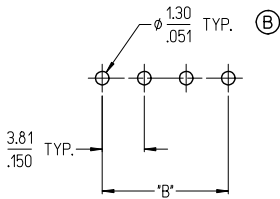

**3954X SERIES  
5.00mm FIXED**

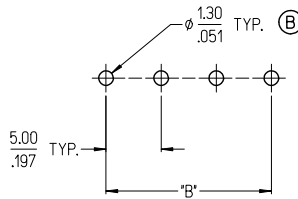

**3954X SERIES  
5.08mm FIXED**

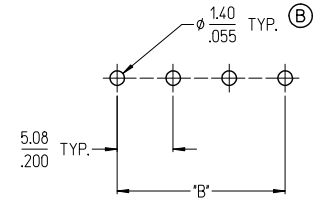

NOTES:

- REFER TO INDIVIDUAL PRODUCT SALES DRAWINGS FOR 'B' DIMENSION.
- DOES NOT APPLY TO DUAL LEVEL HEADERS, SERIES 39528 AND 39538.
- TYP. = TYPICAL.

REV	DESCRIPTION	DATE
01	REV'D DIA'S PER CAT	2003/10/14
02	EC NO: ICG2014-0074	2003/10/16
03	DRW:RSTONE	2003/10/16
04	CHK:OB RUPERT	2003/10/16
05	APP:R:J.MURPHY	2003/11/23

QUALITY SYMBOLS	DESCRIPTION
▽=0	
▽=0	

GENERAL TOLERANCES (UNLESS SPECIFIED)		
	mm	INCH
4 PLACES	± .005	± .0005
3 PLACES	± .005	± .0005
2 PLACES	± 0.13	± .01
1 PLACE	± 0.3	± .01
ANGULAR ± 2°		
DRAFT WHERE APPLICABLE MUST REMAIN WITHIN DIMENSIONS		

DRAWN BY		DATE	
C. YORK		2006/08/25	
CHECKED BY		DATE	
J. MACNEIL		2006/08/25	
APPROVED BY		DATE	
J. MACNEIL		2006/08/25	
MATERIAL NO.			
---			

SCALE	DESIGN UNITS	THIRD ANGLE PROJECTION
	INCH	
TITLE		
RECOMMENDED PCB LAYOUT FOR ESE TERMINAL BLOCKS		
MOLEX INCORPORATED		
DOCUMENT NO.	SHEET NO.	
SD-39501-002	1 OF 1	

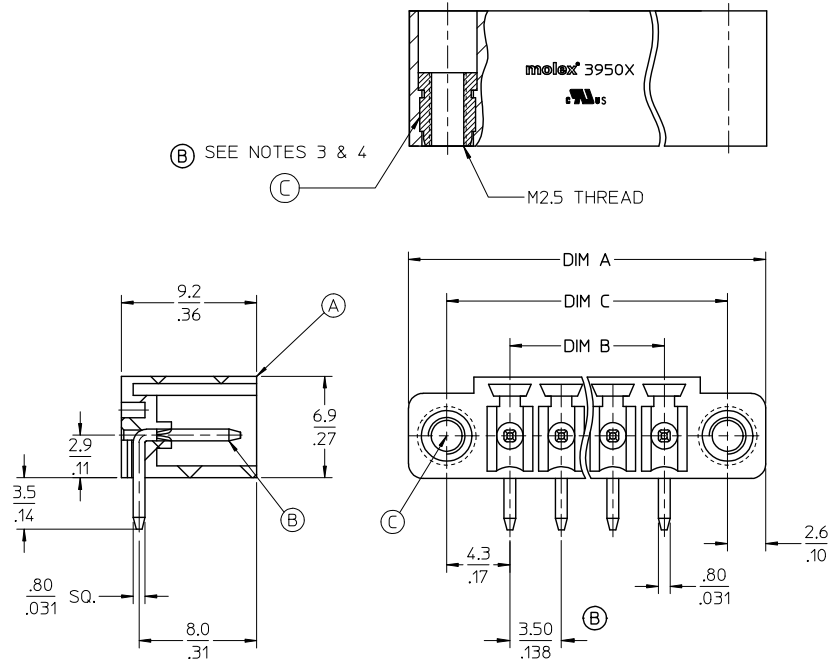

**SPECIFICATIONS:**

**1. Material:**

- A. Body: PA66, UL 94V-0
- B. Terminal: Brass - Tin plated
- C. Threaded Insert: Brass

- 2. Electrical rating: 300V, 8A
- 3. Max Torque: 159 in.lbs. (0.18NM)
- 4. Minimum insert retention: 22 lbf (98N)
- 5. Operating temperature: -40°C to +105°C
- 6. Max. soldering temp: 260°C (500°F) for 5 seconds
- 7. DIM A (overall length)= (N x P) + 10.3mm
- 8. DIM B (circuit length)= (N - 1) x P
- 9. DIM C (mounting holes)= (B + 8.6mm)
- 10. P (PITCH) = 3.50mm (.138")
- 11. N = Number of positions available 2 through 20
- 12. Product spec: PS-39500-001
- 13. See drawing SD-39501-002 for PTH info
- 14. Dims. shown are for reference only

<b>REV D INSERT &amp; NOTES</b> EC NO: JGZ015-0333 DRAWN BY: JDRW/STONE 2014/08/27 CHECKED BY: ARDEN 2014/08/27 APPR: JF/MURPHY 2014/09/12 REV DESCRIPTION	<b>QUALITY SYMBOLS</b> = 0 = 0	<b>GENERAL TOLERANCES (UNLESS SPECIFIED)</b>	<b>DIMENSION STYLE</b> MM/IN	<b>SCALE</b> 4:1	<b>DESIGN UNITS</b> INCH	<b>THIRD ANGLE PROJECTION</b>																
	<table border="1"> <thead> <tr> <th></th> <th>mm</th> <th>INCH</th> </tr> </thead> <tbody> <tr> <td>4 PLACES</td> <td>± .038</td> <td>± .0015</td> </tr> <tr> <td>3 PLACES</td> <td>± 0.038</td> <td>± .005</td> </tr> <tr> <td>2 PLACES</td> <td>± 0.13</td> <td>± .01</td> </tr> <tr> <td>1 PLACE</td> <td>± 0.3</td> <td>± .---</td> </tr> </tbody> </table>		mm	INCH	4 PLACES	± .038	± .0015	3 PLACES	± 0.038	± .005	2 PLACES	± 0.13	± .01	1 PLACE	± 0.3	± .---	DRAWN BY: LROTHAUS DATE: 12/16/05 CHECKED BY: C. YORK DATE: 01/06/06 APPROVED BY:	<b>TITLE</b> 3.5MM, EURO HEADER RIGHT ANGLE, MOUNTING ENDS	<b>MOLEX INCORPORATED</b>	<b>MATERIAL NO.</b> SEE SHEET 2	<b>DOCUMENT NO.</b> SD-39506-001	<b>SHEET NO.</b> 1 OF 2
		mm	INCH																			
	4 PLACES	± .038	± .0015																			
3 PLACES	± 0.038	± .005																				
2 PLACES	± 0.13	± .01																				
1 PLACE	± 0.3	± .---																				
<b>DRAFT WHERE APPLICABLE MUST REMAIN WITHIN DIMENSIONS</b>	<b>SIZE</b> B	THIS DRAWING CONTAINS INFORMATION THAT IS PROPRIETARY TO MOLEX INCORPORATED AND SHOULD NOT BE USED WITHOUT WRITTEN PERMISSION																				
REV D INSERT & NOTES																						

10 9 8 7 6 5 4 3 2 39506

Description	Circuit Size	Material Numbers												Dimensional Information					
		Black						Green						Dim A		Dim B		Dim C	
		100% Tin			30 u" Gold			100% Tin			30 u" Gold			mm	inch	mm	inch	mm	inch
		Printing Options			Printing Options			Printing Options			Printing Options								
		None	10A	11A	None	10A	11A	None	10A	11A	None	10A	11A						
3.5mm, Euro Header, Right Angle, Mounting Ends	2	395061002	395061102	395061202	395061502	395061802	395061702	395068002	395068102	395068202	395068502	395068602	395068702	17.30	0.681	9.50	0.374	12.10	0.478
3.5mm, Euro Header, Right Angle, Mounting Ends	3	395061003	395061103	395061203	395061503	395061803	395061703	395068003	395068103	395068203	395068503	395068603	395068703	20.00	0.019	7.00	0.276	15.80	0.614
3.5mm, Euro Header, Right Angle, Mounting Ends	4	395061004	395061104	395061204	395061504	395061804	395061704	395068004	395068104	395068204	395068504	395068604	395068704	24.30	0.957	10.50	0.413	10.10	0.752
3.5mm, Euro Header, Right Angle, Mounting Ends	5	395061005	395061105	395061205	395061505	395061805	395061705	395068005	395068105	395068205	395068505	395068605	395068705	27.80	1.024	14.00	0.551	22.80	0.899
3.5mm, Euro Header, Right Angle, Mounting Ends	6	395061006	395061106	395061206	395061506	395061806	395061706	395068006	395068106	395068206	395068506	395068606	395068706	31.30	1.232	17.50	0.689	26.10	1.028
3.5mm, Euro Header, Right Angle, Mounting Ends	7	395061007	395061107	395061207	395061507	395061807	395061707	395068007	395068107	395068207	395068507	395068607	395068707	34.90	1.370	21.00	0.827	29.80	1.165
3.5mm, Euro Header, Right Angle, Mounting Ends	8	395061008	395061108	395061208	395061508	395061808	395061708	395068008	395068108	395068208	395068508	395068608	395068708	38.30	1.508	24.50	0.965	33.10	1.303
3.5mm, Euro Header, Right Angle, Mounting Ends	9	395061009	395061109	395061209	395061509	395061809	395061709	395068009	395068109	395068209	395068509	395068609	395068709	41.80	1.646	28.00	1.102	36.80	1.441
3.5mm, Euro Header, Right Angle, Mounting Ends	10	395061010	395061110	395061210	395061510	395061810	395061710	395068010	395068110	395068210	395068510	395068610	395068710	45.30	1.783	31.50	1.240	40.10	1.579
3.5mm, Euro Header, Right Angle, Mounting Ends	11	395061011	395061111	395061211	395061511	395061811	395061711	395068011	395068111	395068211	395068511	395068611	395068711	48.80	1.921	35.00	1.378	43.60	1.717
3.5mm, Euro Header, Right Angle, Mounting Ends	12	395061012	395061112	395061212	395061512	395061812	395061712	395068012	395068112	395068212	395068512	395068612	395068712	52.30	2.059	38.50	1.516	47.10	1.854
3.5mm, Euro Header, Right Angle, Mounting Ends	13	395061013	395061113	395061213	395061513	395061813	395061713	395068013	395068113	395068213	395068513	395068613	395068713	55.80	2.197	42.00	1.654	50.80	1.992
3.5mm, Euro Header, Right Angle, Mounting Ends	14	395061014	395061114	395061214	395061514	395061814	395061714	395068014	395068114	395068214	395068514	395068614	395068714	59.30	2.335	45.50	1.791	54.10	2.130
3.5mm, Euro Header, Right Angle, Mounting Ends	15	395061015	395061115	395061215	395061515	395061815	395061715	395068015	395068115	395068215	395068515	395068615	395068715	62.80	2.472	49.00	1.929	57.60	2.268
3.5mm, Euro Header, Right Angle, Mounting Ends	16	395061016	395061116	395061216	395061516	395061816	395061716	395068016	395068116	395068216	395068516	395068616	395068716	66.30	2.610	52.50	2.067	61.10	2.406
3.5mm, Euro Header, Right Angle, Mounting Ends	17	395061017	395061117	395061217	395061517	395061817	395061717	395068017	395068117	395068217	395068517	395068617	395068717	69.80	2.748	56.00	2.205	64.60	2.543
3.5mm, Euro Header, Right Angle, Mounting Ends	18	395061018	395061118	395061218	395061518	395061818	395061718	395068018	395068118	395068218	395068518	395068618	395068718	73.30	2.886	59.50	2.343	68.10	2.681
3.5mm, Euro Header, Right Angle, Mounting Ends	19	395061019	395061119	395061219	395061519	395061819	395061719	395068019	395068119	395068219	395068519	395068619	395068719	76.80	3.024	63.00	2.480	71.60	2.819
3.5mm, Euro Header, Right Angle, Mounting Ends	20	395061020	395061120	395061220	395061520	395061820	395061720	395068020	395068120	395068220	395068520	395068620	395068720	80.30	3.161	66.50	2.618	75.10	2.957

SEE SHEET 1 EC NO: PG2015-0333 DRAWN BY: DRWINSTONE CHECKED BY: ARDEN APPROV: JMDRPHY 20/08/21 20/08/21 20/08/21	QUALITY SYMBOLS ▽=0 ▽=0	GENERAL TOLERANCES (UNLESS SPECIFIED)		DIMENSION STYLE MM/IN		SCALE 1:1	DESIGN UNITS INCH	THIRD ANGLE PROJECTION		
		4 PLACES ±.0015 3 PLACES ±.0038 2 PLACES ±.01 1 PLACE ±.03 0 PLACE ±	mm ±.0015 ±.005 ±.01 ±.03 ±	INCH ±.0015 ±.005 ±.01 ±.03 ±	DRAWN BY LROTHAUS	DATE 12/6/05	TITLE 3.5MM, EURO HEADER RIGHT ANGLE, MOUNTING ENDS			
		MATERIAL NO. SEE CHART		CHECKED BY C. YORK	DATE 01/06/06	APPROVED BY DATE	DOCUMENT NO. SD-39506-001			
		ANGLER ± 2 ° DRAFT WHERE APPLICABLE MUST REMAIN WITHIN DIMENSIONS		THIS DRAWING CONTAINS INFORMATION THAT IS PROPRIETARY TO MOLEX INCORPORATED AND SHOULD NOT BE USED WITHOUT WRITTEN PERMISSION						

Description	Circuit size	Material Numbers												Dimensional Information					
		Black						Green						Dim A		Dim B		Dim C	
		100% Tin			30 u" Gold			100% Tin			30 u" Gold			mm	inch	mm	inch	mm	inch
		Printing Options			Printing Options			Printing Options			Printing Options								
3.5mm, Euro Header, Right Angle, Mounting Ends	2	395061002	395061102	395061202	395061502	395061602	395061702	395066002	395066102	395066202	395066502	395066602	395066702	17.30	0.681	3.50	0.138	12.10	0.476
3.5mm, Euro Header, Right Angle, Mounting Ends	3	395061003	395061103	395061203	395061503	395061603	395061703	395066003	395066103	395066203	395066503	395066603	395066703	20.80	0.819	7.00	0.276	15.60	0.614
3.5mm, Euro Header, Right Angle, Mounting Ends	4	395061004	395061104	395061204	395061504	395061604	395061704	395066004	395066104	395066204	395066504	395066604	395066704	24.30	0.957	10.50	0.413	19.10	0.752
3.5mm, Euro Header, Right Angle, Mounting Ends	5	395061005	395061105	395061205	395061505	395061605	395061705	395066005	395066105	395066205	395066505	395066605	395066705	27.80	1.094	14.00	0.551	22.60	0.890
3.5mm, Euro Header, Right Angle, Mounting Ends	6	395061006	395061106	395061206	395061506	395061606	395061706	395066006	395066106	395066206	395066506	395066606	395066706	31.30	1.232	17.50	0.689	26.10	1.028
3.5mm, Euro Header, Right Angle, Mounting Ends	7	395061007	395061107	395061207	395061507	395061607	395061707	395066007	395066107	395066207	395066507	395066607	395066707	34.80	1.370	21.00	0.827	29.60	1.165
3.5mm, Euro Header, Right Angle, Mounting Ends	8	395061008	395061108	395061208	395061508	395061608	395061708	395066008	395066108	395066208	395066508	395066608	395066708	38.30	1.508	24.50	0.965	33.10	1.303
3.5mm, Euro Header, Right Angle, Mounting Ends	9	395061009	395061109	395061209	395061509	395061609	395061709	395066009	395066109	395066209	395066509	395066609	395066709	41.80	1.646	28.00	1.102	36.60	1.441
3.5mm, Euro Header, Right Angle, Mounting Ends	10	395061010	395061110	395061210	395061510	395061610	395061710	395066010	395066110	395066210	395066510	395066610	395066710	45.30	1.783	31.50	1.240	40.10	1.579
3.5mm, Euro Header, Right Angle, Mounting Ends	11	395061011	395061111	395061211	395061511	395061611	395061711	395066011	395066111	395066211	395066511	395066611	395066711	48.80	1.921	35.00	1.378	43.60	1.717
3.5mm, Euro Header, Right Angle, Mounting Ends	12	395061012	395061112	395061212	395061512	395061612	395061712	395066012	395066112	395066212	395066512	395066612	395066712	52.30	2.059	38.50	1.516	47.10	1.854
3.5mm, Euro Header, Right Angle, Mounting Ends	13	395061013	395061113	395061213	395061513	395061613	395061713	395066013	395066113	395066213	395066513	395066613	395066713	55.80	2.197	42.00	1.654	50.60	1.992
3.5mm, Euro Header, Right Angle, Mounting Ends	14	395061014	395061114	395061214	395061514	395061614	395061714	395066014	395066114	395066214	395066514	395066614	395066714	59.30	2.335	45.50	1.791	54.10	2.130
3.5mm, Euro Header, Right Angle, Mounting Ends	15	395061015	395061115	395061215	395061515	395061615	395061715	395066015	395066115	395066215	395066515	395066615	395066715	62.80	2.472	49.00	1.929	57.60	2.268
3.5mm, Euro Header, Right Angle, Mounting Ends	16	395061016	395061116	395061216	395061516	395061616	395061716	395066016	395066116	395066216	395066516	395066616	395066716	66.30	2.610	52.50	2.067	61.10	2.406
3.5mm, Euro Header, Right Angle, Mounting Ends	17	395061017	395061117	395061217	395061517	395061617	395061717	395066017	395066117	395066217	395066517	395066617	395066717	69.80	2.748	56.00	2.205	64.60	2.543
3.5mm, Euro Header, Right Angle, Mounting Ends	18	395061018	395061118	395061218	395061518	395061618	395061718	395066018	395066118	395066218	395066518	395066618	395066718	73.30	2.886	59.50	2.343	68.10	2.681
3.5mm, Euro Header, Right Angle, Mounting Ends	19	395061019	395061119	395061219	395061519	395061619	395061719	395066019	395066119	395066219	395066519	395066619	395066719	76.80	3.024	63.00	2.480	71.60	2.819
3.5mm, Euro Header, Right Angle, Mounting Ends	20	395061020	395061120	395061220	395061520	395061620	395061720	395066020	395066120	395066220	395066520	395066620	395066720	80.30	3.161	66.50	2.618	75.10	2.957

SEE SHEET 1 IEC NO: NEO2006-0310 DRAWN BY: LROTHAUS CHKD: CYORK APPR: JFAMILK 2006/01/09 2006/01/10	QUALITY SYMBOLS ▽=0 ▽=0	GENERAL TOLERANCES (UNLESS SPECIFIED)		DIMENSION STYLE	SCALE	DESIGN UNITS	THIRD ANGLE PROJECTION
		mm	INCH	MM/IN	4:1	INCH	
		4 PLACES ± ---	± .0015				
		3 PLACES ± 0.038	± .005				
		2 PLACES ± 0.13	± .01				
		1 PLACE ± 0.3	± ---				
		ANGULAR ± 2°					
		DRAFT WHERE APPLICABLE MUST REMAIN WITHIN DIMENSIONS		DRAWN BY	DATE	TITLE	
				LROTHAUS	12/16/05	3.5MM, EURO HEADER RIGHT ANGLE, MOUNTING ENDS	
				C. YORK	01/06/06		
				MATERIAL NO.	DOCUMENT NO.		SHEET NO.
				SEE CHART	SD-39506-001		2 OF 2
				THIS DRAWING CONTAINS INFORMATION THAT IS PROPRIETARY TO MOLEX INCORPORATED AND SHOULD NOT BE USED WITHOUT WRITTEN PERMISSION			