

Excellent Integrated System Limited

Stocking Distributor

Click to view price, real time Inventory, Delivery & Lifecycle Information:

[NKK Switches](#)
[FTCS04A](#)

For any questions, you can email us directly:
sales@integrated-circuit.com

Contents Touch Screens & Membranes ← NEW

Toggles

Rockers

Pushbuttons

Illuminated PB

Programmable

Keylocks

Rotaries

Slides

Tactiles

Tilt

Touch L

Indicators

Accessories

Supplement

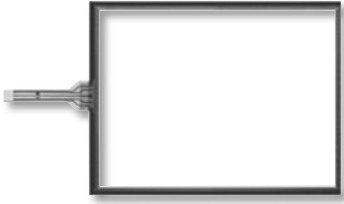

5-Wire TouchscreensL5

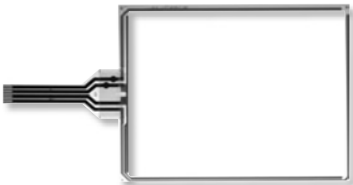

4-Wire TouchscreensL8

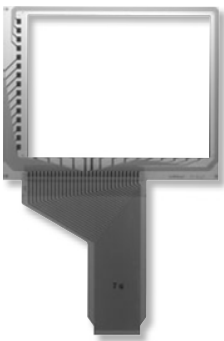

Digital TouchscreensL14



FM MembranesL15

Resistive Touch Screens

5-Wire, 4-Wire & Digital Solutions

NKK's transparent touch screens are engineered to complement the application of choice while offering superior durability and flexibility. With options in multiple sizes, and choices of input by finger, gloved finger or stylus, we maintain a consistent focus on impeccable quality and value added solutions with the diverse needs of our customers at the forefront.

Whether an application requires the 5- or 4-wire technology, the features include metal tails (analog), contact reliability with a connector, and ANR film, eliminating many of the typical visual artifacts. The film surface is non-glare and hard coated for ease of use and integrity of the surface.

Additional benefits of NKK's 5-wire touch screens include:

- Screens highly resistant to static electricity and noise pollution
- Drift-free operation despite any temperature fluctuation
- Greater touch point density translating to more precision and reduction of false actuations
- Quicker response time

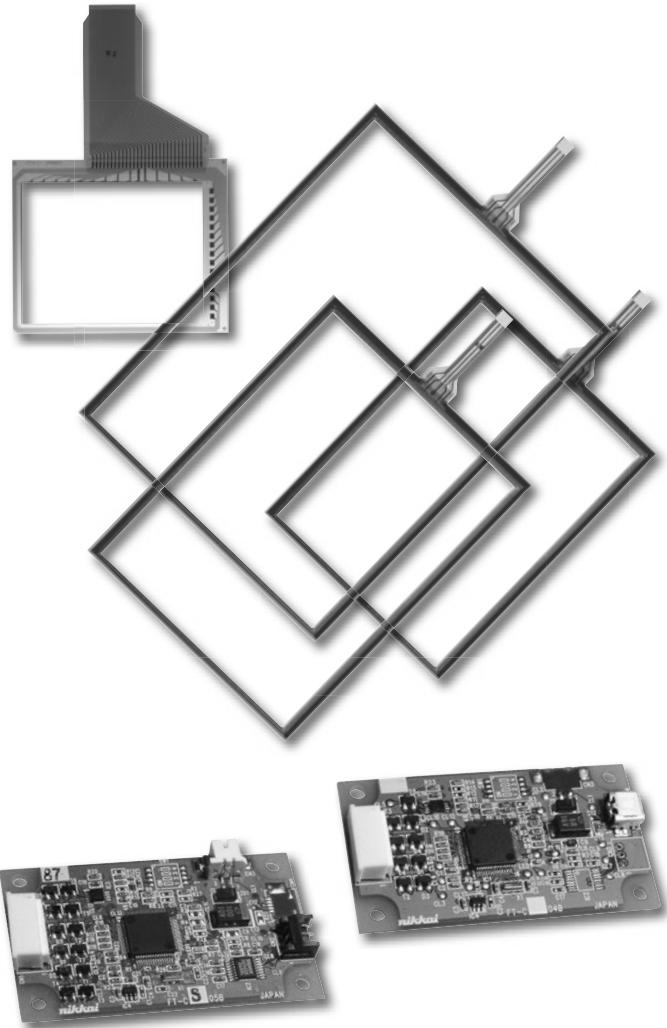

DISTINCTIVE CHARACTERISTICS

- Wide Range of Available Sizes
- Custom Solutions a Specialty
- Digital and Analog Solutions
- Controllers Available
- Anti-Newton Ring (ANR) Technology
- Design Minimizes Visual Artifacts
- RoHS Compliant

APPLICATIONS

- Information Kiosks
- Industrial Automation
- Banking, Exchange Management Systems
- Broadcast
- Office Automation
- Medical Equipment
- Hand-held Devices
- Hospitality and Restaurant
- Gaming

Series FT

NEW → Touch Screens

Customization Options

Parameter	Notes & Options
Resistive Analog Touch Screen	4-Wire or 5-Wire
Integrate LCD & Touchscreen	Yes - No
5-Wire - Screen Size Diagonal Inches	Standard 10.4, 12.1, 15 (min 10.4, max 19)
4-Wire - Screen Size Diagonal Inches	Standard 5.7, 6.5, 8.4, 10.4, 12.1, 15 (min 2.5, max 19)
Data Entry Area mm x mm	Same as the dimensions of the display area of the LCD
Viewable Area mm x mm	Same as the dimensions of the bezel opening of the LCD
Perimeter Dimensions mm x mm	
Tail Type	PCB standard, FPC option
Tail Pitch	1.25mm is standard
Tail Pins	8 is standard, 4 is option
Tail Length	2 standard options: 65mm or 80mm
Tail Base Width	28.2mm is standard
Tail Location	Left side is standard, non-std options top or bottom
Tail Material	Carbon-coated silver is standard, option is copper-gold
Glass Thickness	1.1 and 1.8mm are standard (note: total thickness = glass thickness + 0.3mm)
Hardcoat Treatment	Standard
Anti-Newton Ring Treatment	Standard
Optical Transmission Factor	80% is standard
Controller	Yes - No (no = customer will supply)
Communication	USB or RS232
Operating System	Windows 7 or Windows XP

Toggles

Rockers

Pushbuttons

PB

Illuminated

Keylocks

Rotaries

Slides

Tactiles

Tilt

Touch

Indicators

Accessories

Supplement

Series FT

5-Wire Touch Screens ← NEW

GENERAL SPECIFICATIONS FOR 5-WIRE

5-Wire Resistive Analog Touch Screens

Optical	
Light Transmission	80% standard
Film Options	Anti-glare, anti-Newton ring standard
Electrical	
Power Level	5.5V DC
X Y Resistive Value	20 ~ 80Ω
Insulation Impedance	10MΩ minimum @ 25V DC
Linearity	±2% maximum (after adjustment made by control board or device driver)
Chattering Time	10 milliseconds maximum
Mechanical	
Touch Activation Force	1.47N
Available Sizes	10.4", 12.1" and 15.0"
Durability	
Surface Hardness	2H (JIS K5600)
Expected Operational Life	Writing: 50,000 minimum operations (approximately 30mm movement with stylus)
	Tapping: 10,000,000 operations minimum (using silicon rubber)
Environmental	
Operating Temperature Range	-20°C ~ +70°C (-4°F ~ +158°F)
Storage Temperature Range	-40°C ~ +80°C (-22°F ~ +158°F)
Relative Humidity	+60°C (+140°F), humidity 90%, 240 hours

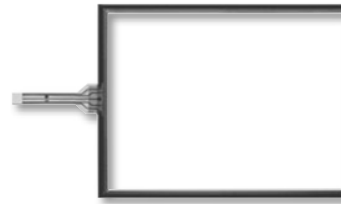

FTAS00-104A5

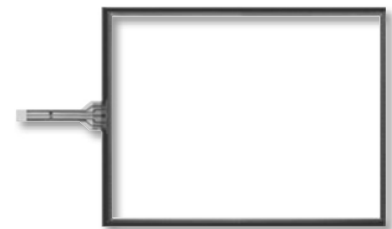

FTAS00-121A5

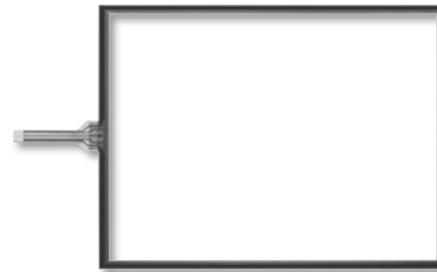

FTAS00-150A5

PART NUMBERS & DESCRIPTIONS FOR 5-WIRE

5-Wire Analog Touch Screens						
Part Number	Screen Size in Inches	Key Area Dimensions	Viewing Area Dimensions	External Dimensions	Panel Thickness	Terminal Detail 8 Pin .049" (1.25mm) Pitch
FTAS00-104A5	10.4	8.5" x 6.45" (215.9mm x 163.9mm)	8.66" x 6.61" (219.9mm x 167.9mm)	9.31" x 7.22" (236.5mm x 183.3mm)	.083" (2.1mm)	Length 3.15" (80.0mm)
FTAS00-121A5	12.1	9.8" x 7.37" (249.0mm x 187.2mm)	9.94" x 7.50" (252.4mm x 190.6mm)	10.52" x 8.1" (267.1mm x 205.8mm)	.083" (2.1mm)	Length 3.15" (80.0mm)
FTAS00-150A5	15.0	12.05" x 9.06" (306.1mm x 230.1mm)	12.19" x 9.19" (309.5mm x 233.5mm)	12.79" x 9.79" (324.8mm x 248.7mm)	.083" (2.1mm)	Length 3.15" (80.0mm)

Note: See web site for dimensioned drawings for all 5-Wire Analog Touch Screens.

Toggles
 Rockers
 Pushbuttons
 Illuminated PB
 Programmable
 Keylocks
 Rotaries
 Slides
 Tactiles
 Tilt
 Touch
 Indicators
 Accessories
 Supplement

Series FT

NEW → 5-Wire Touch Screens

GENERAL SPECIFICATIONS FOR 5-WIRE

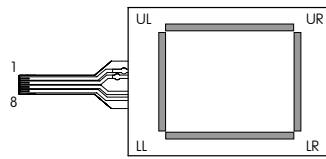
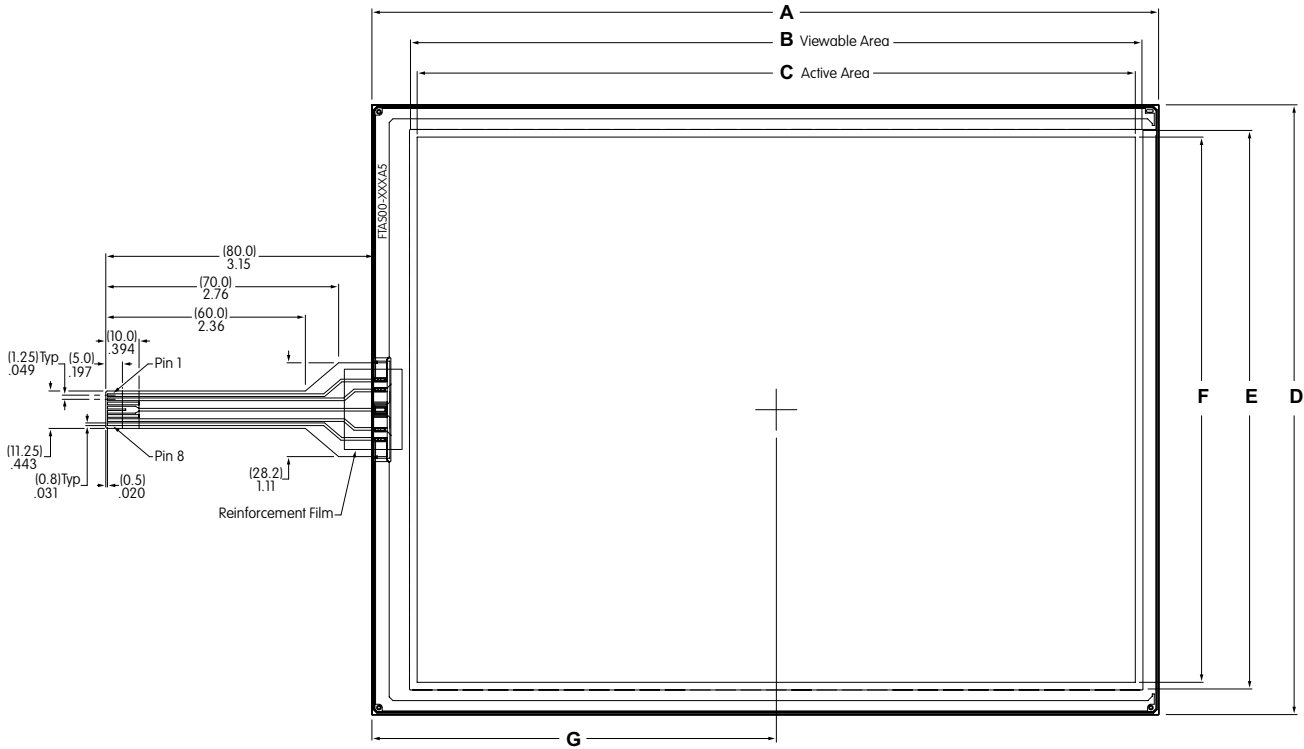

UL, LL, UR, LR: Bottom Electrode Terminal
 SENSE: Top Electrode Terminal

Pins	Signal
1	UR
2	UL
3	NC
4,5	SENSE
6	NC
7	LL
8	LR

5-Wire Analog Touch Screen Dimensions

Part Number	Screen Size in Inches	Dim A	Dim B Viewable Area	Dim C Active Area	Dim D	Dim E Viewable Area	Dim F Active Area	Dim G Center of Active Area
FTAS00-104A5	10.4	9.31 (236.5) +/-0.3	8.66 (219.9)	8.50 (215.9)	7.22 (183.3) +/-0.3	6.61 (167.9)	6.45 (163.9)	4.79 (121.55)
FTAS00-121A5	12.1	10.52 (267.1) +/-0.3	9.94 (252.4)	9.80 (249.0)	8.10 (205.8) +/-0.3	7.50 (190.6)	7.37 (187.2)	5.37 (136.4)
FTAS00-150A5	15.0	12.79 (324.8) +/-0.3	12.19 (309.5)	12.05 (306.1)	9.79 (248.7) +/-0.3	9.19 (233.5)	9.06 (230.1)	6.49 (164.95)

Controller & Drivers ← *NEW*

Series FT

5-Wire Touch Screen Controller Boards & Drivers

DISTINCTIVE CHARACTERISTICS

- High Quality and Reliability
- Easy Integration Replacing Mouse Functionality
- Compatible with Control Board USB/RS232C
- Device Driver Compatible with Vista and Windows XP Operating Systems

Controller Boards Available for RS232C

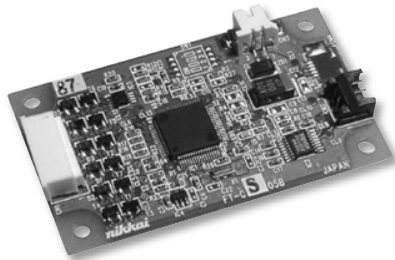

Controller Boards Available for USB

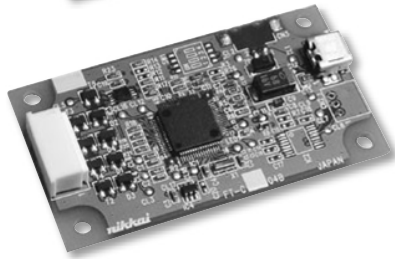

NKK offers controller boards compatible with USB or with RS232C. See web site or contact factory for specifications and technical data.

Controller Boards		
Type	Part No.	Communication Protocol
5-Wire	FTCS05B	RS232C
5-Wire	FTCU05B	USB

See web site for dimensioned drawings or technical data for any of the controller boards and drivers.

IC & Accessories

DISTINCTIVE CHARACTERISTICS

- Interface: USB and RS232C
- High Speed and Accuracy
- Built-in Calibration Function
- Data Function Removal Built In to Eliminate Noise



IC FTCSU564

The IC is for use with the 5- and 4-wire transparent touch screens, and is available for those who prefer to design their own controller boards. When the screen is touched, it recognizes the position of the touch by the level of analog voltage detected by the A/D. The A/D converter receives the value and sends a set of coordinate values as serial data or USB.

See web site or contact factory for IC specifications.

OPTIONAL ACCESSORIES

AT713 Receptacle Connector

This Receptacle Connector with code connects to RS232C communication of the controller boards.



AT714 Receptacle Connector

AT714 is a Receptacle Connector with code to connect to power source of the control boards.



For more details and dimensioned drawings of the accessories, go to the web site or call our engineering support personnel.

Toggles
Rocker
Pushbuttons
Illuminated PB
Programmable
Keylocks
Rotaries
Slides
Tactiles
Tilt
Touch
Indicators
Accessories
Supplement

Series FT

NEW → **4-Wire Touch Screens**

GENERAL SPECIFICATIONS FOR 4-WIRE

4-Wire Analog Resistive Touch Screens

Optical	
Light Transmission	Analog: 80% standard Digital: 78% standard
Film Options	Anti-glare, anti-Newton ring standard
Electrical	
Power Level	1mA @ 5V DC (resistive load)
Insulation Impedance	10MΩ minimum @ 25V DC
Linearity	3% maximum (analog)
Chattering Time	10 milliseconds maximum
Mechanical	
Touch Activation Force	1.4N maximum
Available Sizes	5.7" ~ 15" standard
Durability	
Surface Hardness	2H (JIS K5600)
Expected Operational Life	1,000,000 operations minimum
Environmental	
Operating Temperature Range	-10°C ~ +60°C (+14°F ~ +140°F)
Storage Temperature Range	-20°C ~ +70°C (-4°F ~ +158°F)
Relative Humidity	+60°C (+140°F), humidity 90%, 240 hours

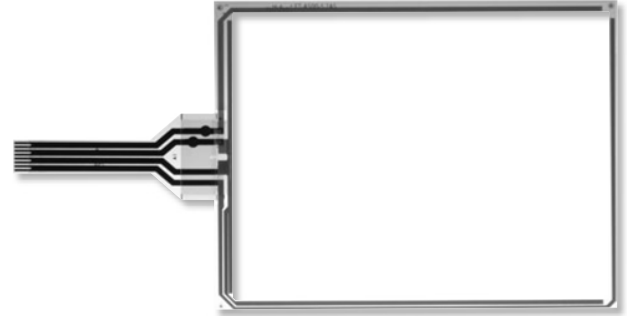

**Analog
FTAS00-57AS4**

PART NUMBERS & DESCRIPTIONS FOR 4-WIRE

4-Wire Analog Touch Screens						
Part Number	Screen Size in Inches	Key Area Dimensions	Viewing Area Dimensions	External Dimensions	Panel Thickness	* Terminal Detail 8 Pin .049" (1.25mm) Pitch
FTAS00-57AS4	5.7	4.54" x 3.40" (115.2mm x 86.4mm)	4.76" x 3.61" (121.0mm x 91.6mm)	5.16" x 3.98" (131.0mm x 101.0mm)	.055" (1.4mm)	Length 2.56" (65.0mm)
FTAS00-65AS4	6.5	5.20" x 3.90" (132.0mm x 99.0mm)	5.43" x 4.13" (138.0mm x 105.0mm)	5.91" x 4.57" (150.0mm x 116.0mm)		Length 2.56" (65.0mm)
FTAS00-84AS4	8.4	6.73" x 5.10" (170.9mm x 129.6mm)	6.95" x 5.33" (176.5mm x 135.4mm)	7.34" x 5.69" (186.5mm x 144.4mm)	.083" (2.1mm)	Length 3.15" (80.0mm)
FTAS00-104AS4	10.4	8.32" x 6.24" (211.2mm x 158.4mm)	8.47" x 6.39" (215.0mm x 162.4mm)	8.88" x 6.75" (225.6mm x 171.4mm)		Length 3.15" (80.0mm)
FTAS00-104AV4	10.4	8.35" x 6.28" (212.2mm x 159.4mm)	8.52" x 6.43" (216.4mm x 163.4mm)	8.92" x 7.21" (226.5mm x 183.0mm)		Length 3.15" (80.0mm)
FTAS00-121A4	12.1	9.72" x 7.30" (246.76mm x 185.32mm)	10.04" x 7.53" (255.0mm x 191.32mm)	10.67" x 8.07" (271.0mm x 205.0mm)		Length 3.15" (80.0mm)
FTAS00-121AS4	12.1	9.69" x 7.26" (246.0mm x 184.5mm)	9.84" x 7.42" (250.0mm x 188.5mm)	10.28" x 7.80" (261.0mm x 198.0mm)		Length 3.15" (80.0mm)
FTAS00-150A4	15.0	12.05" x 9.06" (306.1mm x 230.1mm)	12.21" x 9.25" (310.0mm x 235.0mm)	12.91" x 9.84" (328.0mm x 250.0mm)		Length 3.15" (80.0mm)

Note: Input methods are finger or stylus.

* 4 pin available with 1.0mm or 1.25mm pitch. Contact factory for details.

4-Wire Touch Screens ← **NEW**

4-Wire with Horizontal Tail

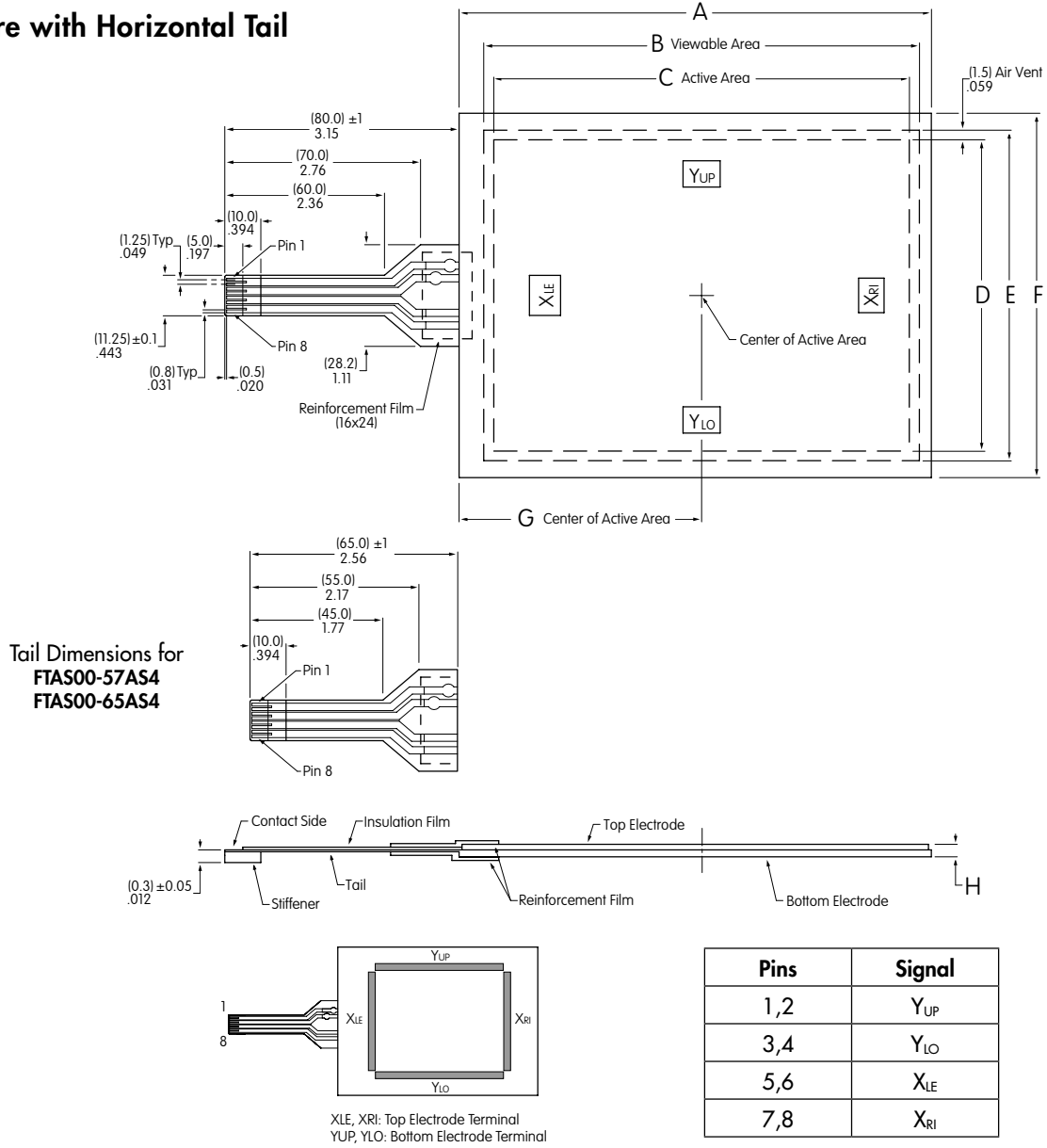

4-Wire Analog Touch Screen Dimensions

Part Number	Screen Size in Inches	Dim A	Dim B Viewable Area	Dim C Active Area	Dim D	Dim E Viewable Area	Dim F Active Area	Dim G Center of Active Area	Dim H
FTAS00-57AS4	5.7	5.16" (131±0.3mm)	4.76" (121mm)	4.54" (115.2mm)	3.40" (86.4mm)	3.61" (91.6mm)	3.98" (101±0.3mm)	2.65" (67.25mm)	.055" (1.4mm)
FTAS00-65AS4	6.5	5.91" (150±0.3mm)	5.43" (138mm)	5.20" (132mm)	3.90" (99mm)	4.13" (105mm)	4.57" (116±0.3mm)	3.03" (77mm)	.055" (1.4mm)
FTAS00-84AS4	8.4	7.34" (186.5±0.3mm)	6.95" (176.5mm)	6.73" (170.9mm)	5.10" (129.6mm)	5.33" (135.4mm)	5.69" (144.4±0.3mm)	3.73" (94.85mm)	.083" (2.1mm)
FTAS00-104AS4	10.4	8.88" (225.6±0.3mm)	8.46" (215mm)	8.31" (211.2mm)	6.24" (158.4mm)	6.39" (162.4mm)	6.75" (171.4±0.3mm)	4.49" (114.1mm)	.083" (2.1mm)
FTAS00-121AS4	12.1	10.28" (261±0.3mm)	9.84" (250mm)	9.69" (246mm)	7.26" (184.5mm)	7.42" (188.5mm)	7.80" (198±0.3mm)	5.18" (131.6mm)	.083" (2.1mm)
FTAS00-150A4	15.0	12.91" (328±0.3mm)	12.20" (310mm)	12.05" (306.1mm)	9.06" (230.1mm)	9.25" (235mm)	9.84" (250±0.3mm)	6.52" (165.6mm)	.083" (2.1mm)

Toggles
Rocker
Pushbuttons
PB
Illuminated
Programmable
Keylocks
Rotaries
Slides
Tactiles
Tilt
Touch
Indicators
Accessories
Supplement

Series FT

NEW → **4-Wire Touch Screens**

4-Wire with Vertical Tail

FTAS00-104AV4

Toggles

Rockers

Pushbuttons

Illuminated PB

Programmable

Keylocks

Rotaries

Slides

Tactiles

Tilt

Indicators

Accessories

Supplement

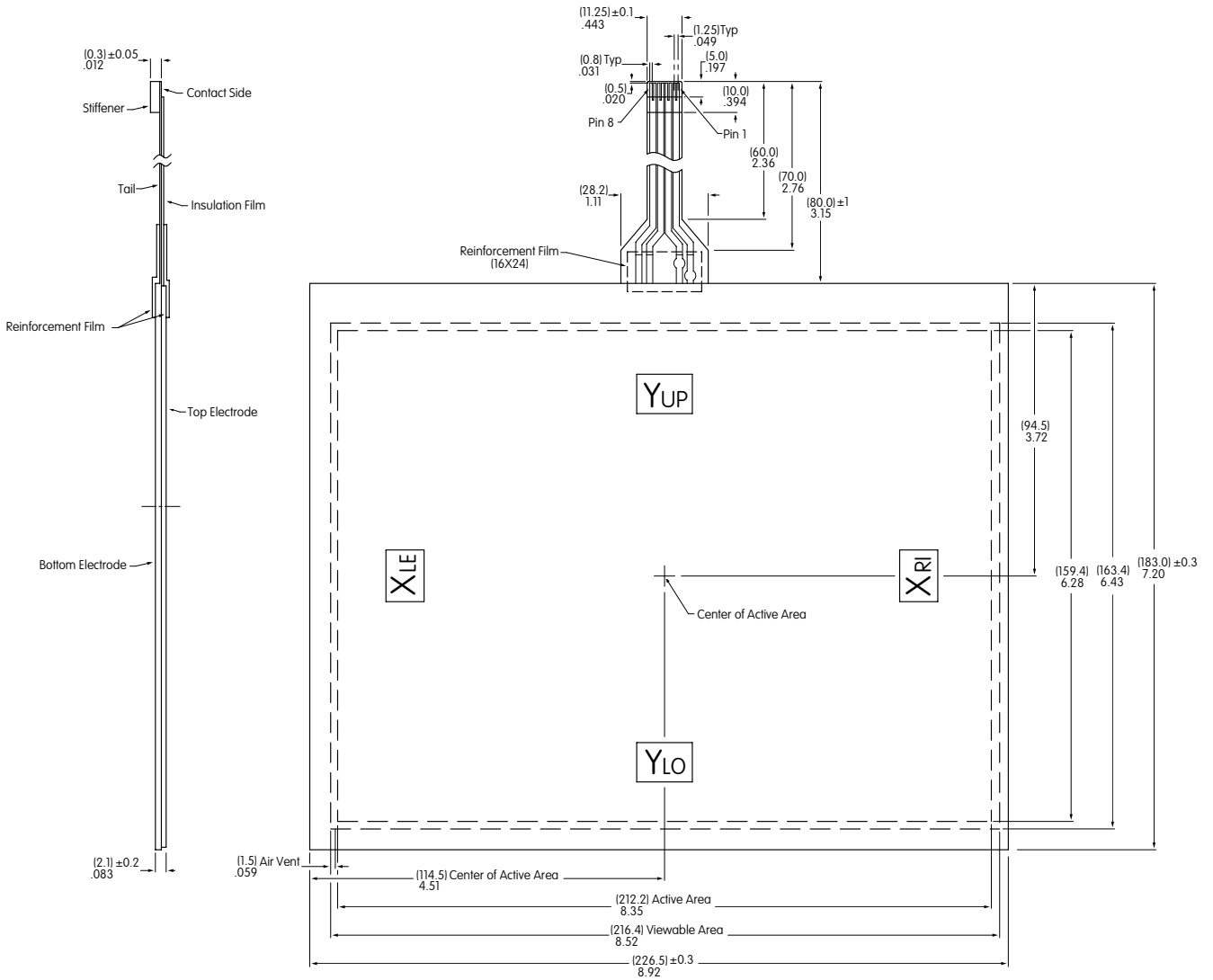

Pins	Signal
1,2	Y _{UP}
3,4	Y _{LO}
5,6	X _{RI}
7,8	X _{LE}

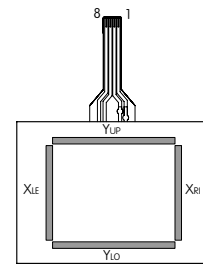

XLE, XRI: Top Electrode Terminal
YUP, YLO: Bottom Electrode Terminal

4-Wire Touch Screens ← **NEW**

Series FT

4-Wire with Horizontal Tail (Off-Center)

FTAS00-121A4

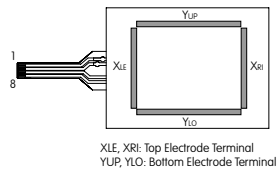
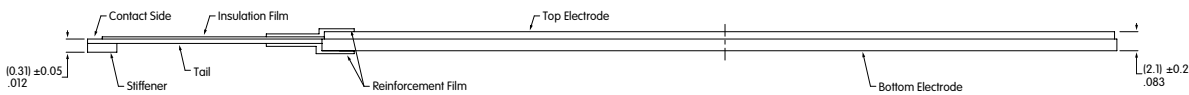
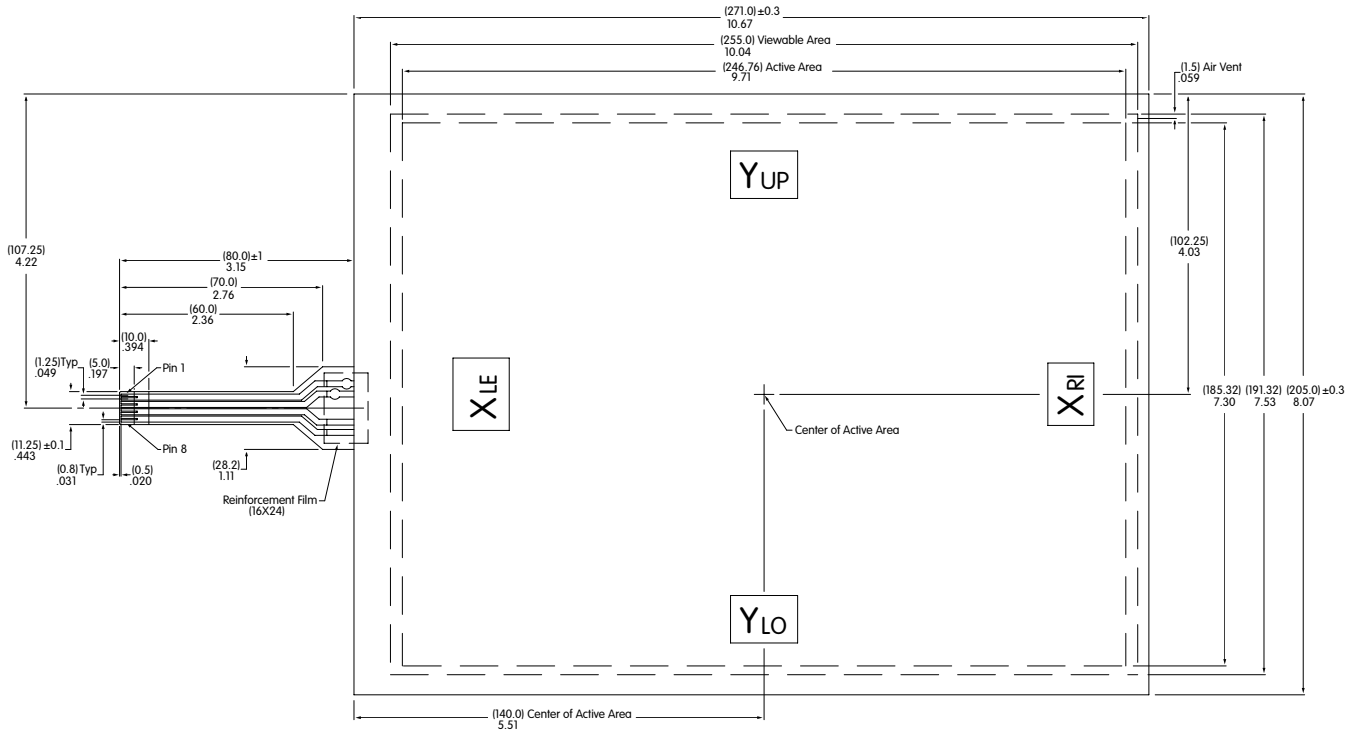

Pins	Signal
1,2	Y _{UP}
3,4	Y _{LO}
5,6	X _{LE}
7,8	X _{RI}

Toggles
 Rockers
 Pushbuttons
 Illuminated PB
 Programmable
 Keylocks
 Rotaries
 Slides
 Tactiles
 Tilt
 Indicators
 Accessories
 Supplement



Series FT

NEW → **Controllers & Drivers**

4-Wire Touch Screen Controller Boards & Drivers

DISTINCTIVE CHARACTERISTICS

- High Quality and Reliability
- Easy Integration Replacing Mouse Functionality
- Compatible with Control Board USB/RS232C
- Device Driver Compatible with Vista and Windows XP Operating Systems

Controller Boards Available for RS232C



Controller Boards Available for USB

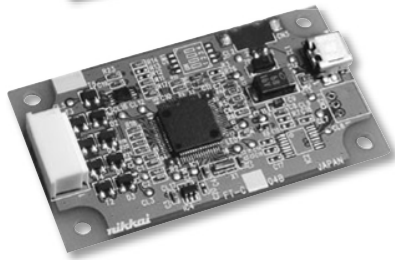

NKK offers controller boards compatible with USB or with RS232C. See web site or contact factory for specifications and technical data.

Controller Boards		
Type	Part No.	Communication Protocol
4-Wire	FTCS04B	RS232C
4-Wire	FTCU04B	USB

See web site for dimensioned drawings or technical data for any of the controller boards and drivers.

IC & Accessories

DISTINCTIVE CHARACTERISTICS

- Interface: USB and RS232C
- High Speed and Accuracy
- Built-in Calibration Function
- Data Function Removal Built In to Eliminate Noise



IC FTCSU564

The IC is for use with the 5- and 4-wire transparent touch screens, and is available for those who prefer to design their own controller boards. When the screen is touched, it recognizes the position of the touch by the level of analog voltage detected by the A/D. The A/D converter receives the value and sends a set of coordinate values as serial data or USB.

See web site or contact factory for IC specifications.

OPTIONAL ACCESSORIES

AT713 Receptacle Connector

This Receptacle Connector with code connects to RS232C communication of the controller boards. It is compatible with FTCS04A and FTCS04A2.



AT714 Receptacle Connector

AT714 is a Receptacle Connector with code to connect to power source of the control boards.



For more details and dimensioned drawings of the accessories, go to the web site or call our engineering support personnel.

Storage, Handling & Installation

Below are some general precautions for the 5-wire & 4-wire touch screen devices. Please check web site for complete documentation.

Installation (4-wire, 5-wire)

- Do not pull on the tail. Do not apply stress to the tail area.
- Avoid vibration or shock.
- The touch screen mounting should not be loose.
- Ensure there are no burrs around the edges of the case or housing that can cause false actuation. The edges of the case or housing should not enter the keying area.
- The case or housing and upper electrode should have a space of about 0.5 mm to accommodate expansion or shrinkage due to humidity variances. If a shock barrier is used do not press hard on the upper electrode area. Any shock barrier should be installed more than 0.6 mm above the screen.
- To secure the touch screen, secure the lower portion with an item such as the LCD display panel. Do not secure the upper electrode with double-sided tape or similar items to avoid stress that can damage the upper or lower electrode.
- In order to balance upper and lower pressure, an air vent may be installed. Ensure that no liquid or oil will enter into the device.

Handling Precautions (4-wire, 5-wire)

- When opening product, take precaution with up/down and front/back directions. Glass edges are not chamfered, corners or edges can be sharp. Wear gloves when handling the product.
- Do not pick up the product by the tail or pull the tail area.
- Use gloves or finger cots to prevent fingerprints on surface.
- When handling the product, hold it outside of the viewing area.
- Avoid stacking multiple products or placing other items on the product.
- Remove protective film after installation is completed.

Operating Precautions (4-wire, 5-wire)

- Only operate with fingers or a touch screen stylus.
- Do not press hard with pen or similar objects between viewing area and key area.

Design Precautions (4-wire, 5-wire)

- With analog type, resistive value change can dislocate the input area. Input area can be calibrated with software.
- When installing on top of a LCD, noise from the display device can create misoperation. To avoid noise, implement actions such as grounding the display device frame.
- Do not create software for simultaneous touch points as analog type will read the center point between two touch points.
- When used to draw a line, analog type will have a break at dot spacer. Compensate for this with software.

Other Precautions (4-wire, 5-wire)

- Clean with a soft cloth and ethanol. Do not use any cleaning agents other than ethanol.
- Store product in original package and store at the temperature and humidity range specified.
- Do not store in an environment with acids or other corrosive gases or dew.
- Not suited for use in critical control systems such as nuclear power, aerospace, medical or transportation equipment, without proper failsafe design consideration.

Handling Precautions (5-wire)

- NKK warranties the 5-wire touch panel when it is used with the NKK control board and driver. Do not use third party control boards.
- 5-wire devices can misalign cathode position or touch position even after calibration. See web site for details.
- Create a larger input area. If you have the input button at the edge of a screen, it might not operate properly.
- Complete 9 point calibration with NKK driver. If more precision is desired, 25 point calibration is recommended.

Handling of Controller Board (5-wire)

- Warranty for one year after delivery. We do not warranty the controller board unless used with NKK touch panel.
- Use arc prevention to protect device from static electricity.
- Power source should be activated after host and touch panel are connected.
- When inserting connector CN1 and touch panel tail, be sure the slider of connector CN1 is pulled. Do not pull more than 10 times.
- Do not alter the product.
- Do not use any commands other than the ones specified in specifications.
- Place the product away from noise source (such as inverter from LCD operation) since tail can be affected by noise.
- If device driver (USB) does not work after installation, reboot the host computer while connected to the controller board.
- This product does not support suspended mode (USB).
- Protocol of USB transmission is one frame per one transaction.
- Contact factory if not using protocol above.

Series FT

NEW → Digital Touch Screen

Toggles

Rockers

Pushbuttons

Programmable Illuminated PB

Keylocks

Rotaries

Slides

Tactiles

Tilt

Touch

Indicators

Accessories

Supplement

Digital Touch Screen

Part Number	Screen Size in Inches	Key Area Dimensions	Viewing Area Dimensions	External Dimensions	Panel Thickness	Terminal Detail 30 Pin .039" (1.0mm) Pitch
FTAS225-57AN	5.7	4.54" x 3.39" (115.2mm x 86.04mm)	4.80" x 3.62" (122.0mm x 92.0mm)	5.51" x 4.45" (140.0mm x 113.0mm)	.083" (2.1mm)	Length 3.94" (100.0mm)

Notes: Input method is finger. Number of keys for Digital Touch Screen: 15 x 15. See web site for dimensioned drawings for the Digital Touch Screen.

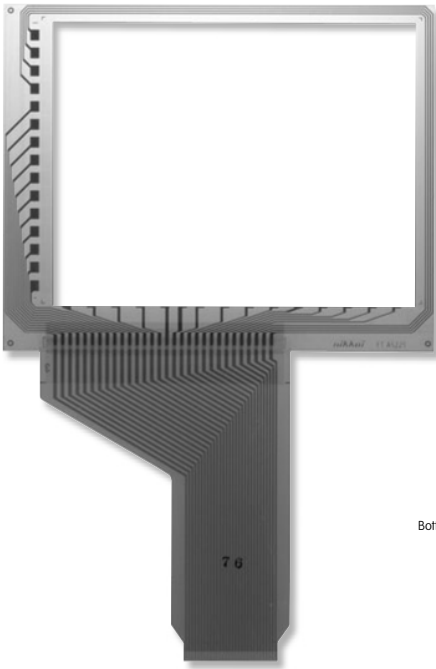

Digital
FTAS225-57AN

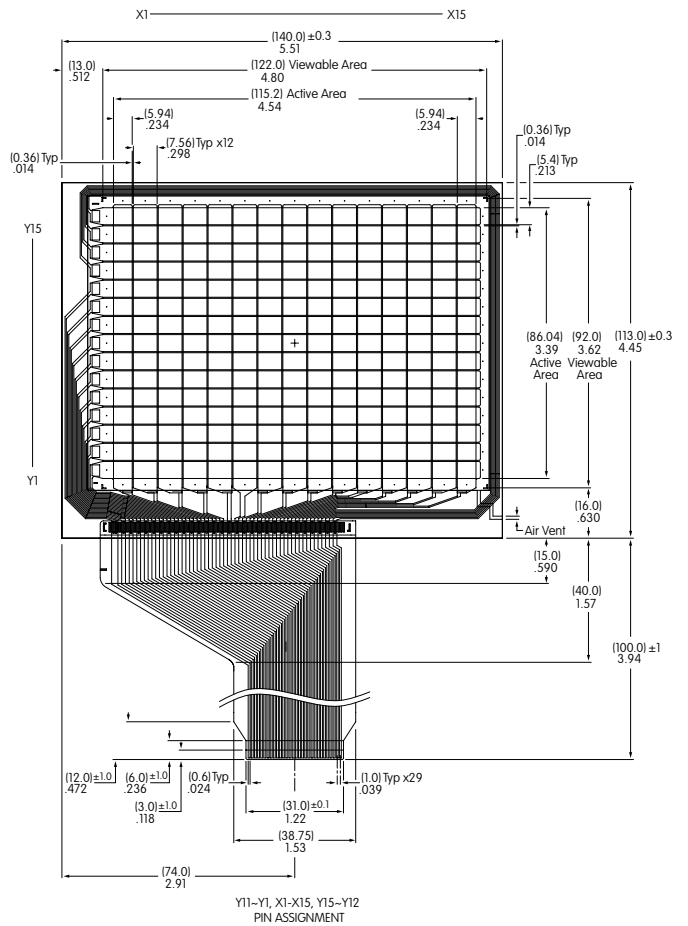
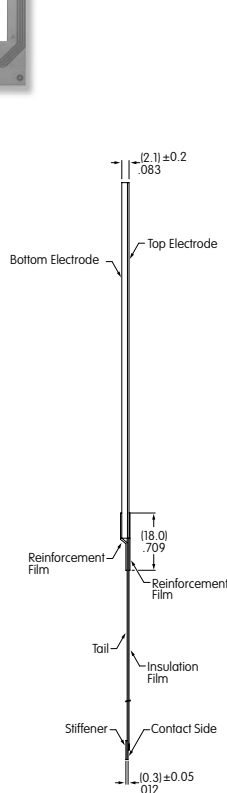

Y11-Y1, X1-X15, Y15-Y12
PIN ASSIGNMENT

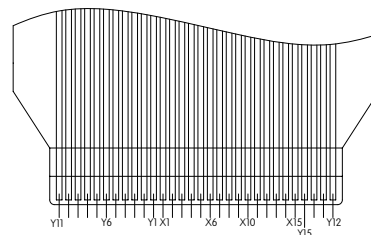

Y11-Y1, X1-X15, Y15-Y12
PIN ASSIGNMENT

Membranes ← NEW

Series FM

DISTINCTIVE CHARACTERISTICS

- Nonilluminated options in 4 or 16 keys, illuminated choices in 12 or 16 keys
- 1.0mm (.039") tail pitch
- Easily integrated into designs: replaces multiple mechanical switches, soldered wires and cable assemblies
- Card insertion into design supports customized legends for nonilluminated models
- Actuating dome offers crisp, tactile feedback to positively indicate circuit transfer
- Illuminated models feature legends on embossed keypads
- Adhesive backing for easy mounting

GENERAL SPECIFICATIONS

Power Level	20mA @ 24V DC
Contact Resistance	500Ω maximum (10mA @ 10V DC)
Insulation Resistance	100 megohms minimum @ 250V DC minimum
Dielectric Strength	250V AC minimum for one minute minimum
Operational Life	1,000,000 operations minimum
Contact Timing	10 milliseconds maximum
Nominal Operating Force	1.0N ~ 6.0N
Stroke:	
Nonilluminated	.016" ~ .039" (0.4mm ~ 1.0mm)
Illuminated with Overlay	.020" ~ .047" (0.5mm ~ 1.2mm)
Operating Temperature Range	-15°C ~ +50°C (+5°F ~ +122°F) illuminated -15°C ~ +55°C (+5°F ~ +131°F) nonilluminated

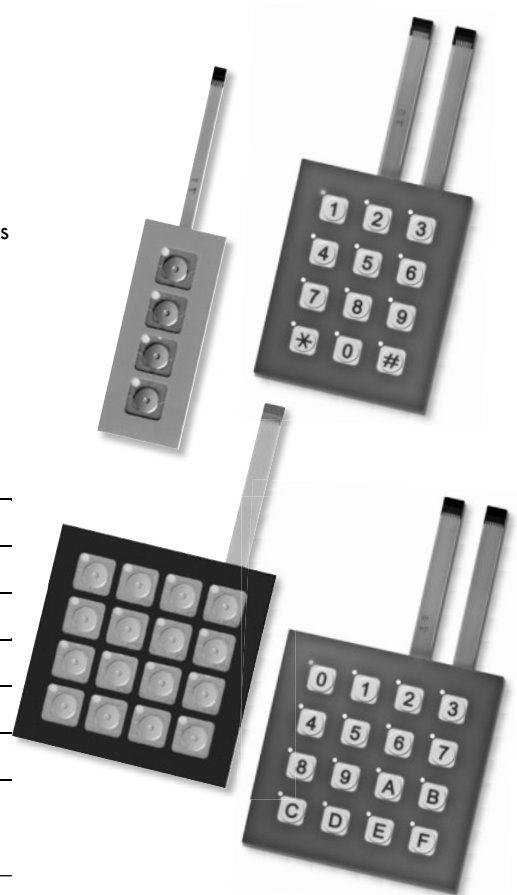

Toggles
Rockers
Pushbuttons
Illuminated PB
Programmable
Keylocks
Rotaries
Slides

LED SPECIFICATIONS

Single Element LED Color: Amber		Unit	
Forward Voltage (Typical)	V _F	2.1	V
Forward Current (Typical)	I _F	20	mA
Forward Current (Maximum)	I _F	30	mA
* Forward Peak Current (Max)	I _{FM}	195	mA
Reverse Voltage (Maximum)	V _R	5.0	V

The electrical specifications shown are determined at a basic temperature of 25°C. LED is an integral part of the switch. LEDs are not sold separately.

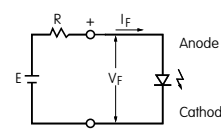

$$R = \frac{E - V_F}{I_F}$$

Where: R = Resistor Value (Ohms)
 E = Source Voltage (V)
 V_F = Forward Voltage (V)
 I_F = Forward Current (A)

LED circuits are isolated and require an external power source. If the source voltage exceeds the rated voltage, a ballast resistor is required.

* Note: Pulse width 0.1msec maximum with a maximum duty cycle ratio of 1/10

Ordering Information

Part Number	Illumination	Number of Keys	Surface Sheet		Overlay
			Black (D)	Gray (E)	
FMBN04BD	Nonilluminated	4	•		
FMBN04BE		4		•	
FMBN16BD		16	•		
FMBN16BE		16		•	
FMBP12BF	Dot Illuminated with Overlay	12			Gray Surface Sheet with Embossed White Keypad and Gray Legends
FMBP16BF		16			

Tactiles
Tilt
Touch
Indicators
Accessories
Supplement

Series FM

NEW → **Membranes**

TYPICAL SWITCH DIMENSIONS

Nonilluminated • 4 or 16 Keys

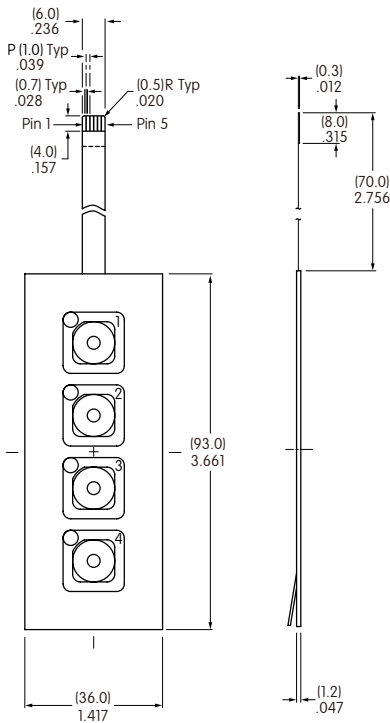

Switch Circuit Matrix For 4 Key

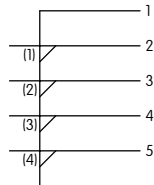

Key numbers in parenthesis are not actually on panel and are for reference only

Switch Circuit Matrix Detail For 4 or 16 Key

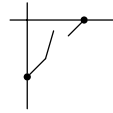

Switch Circuit Matrix For 16 Key

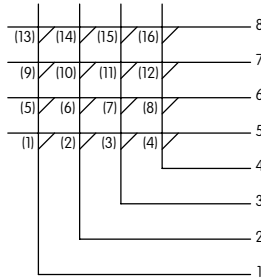

Key numbers in parenthesis are not actually on panel and are for reference only

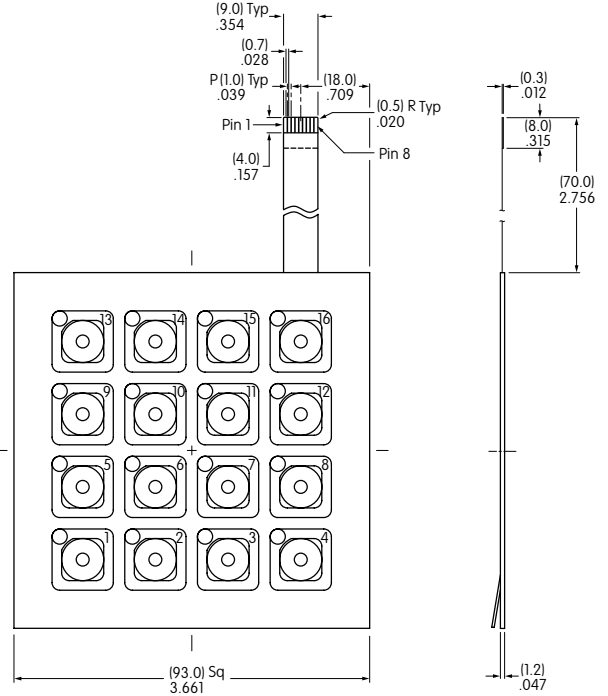

FMBN04BE
Gray
Surface
Sheet

FMBN16BD
Black
Surface
Sheet

Insertable Legend Card for 4 Key or 16 Key

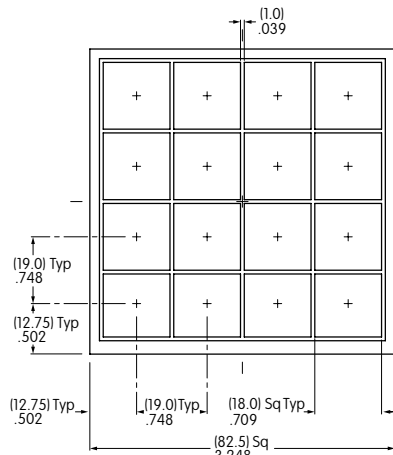
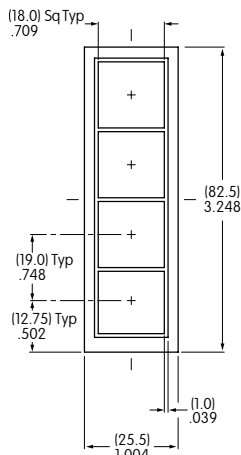

Insertable Legend Cards are supplied with the nonilluminated switch keypad assembly in Black, Gray and Yellow

Toggles

Rockers

Pushbuttons

Programmable Illuminated PB

Keylocks

Rotaries

Slides

Tactiles

Tilt

Touch

Indicators

Accessories

Supplement

Membranes ← **NEW**

Series FM

TYPICAL SWITCH DIMENSIONS

Illuminated • 12 or 16 Keys

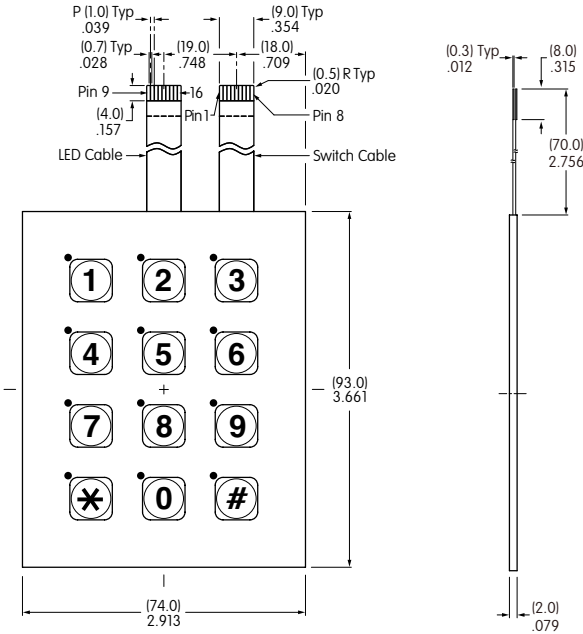

Dot illumination at upper left corner of each keypad

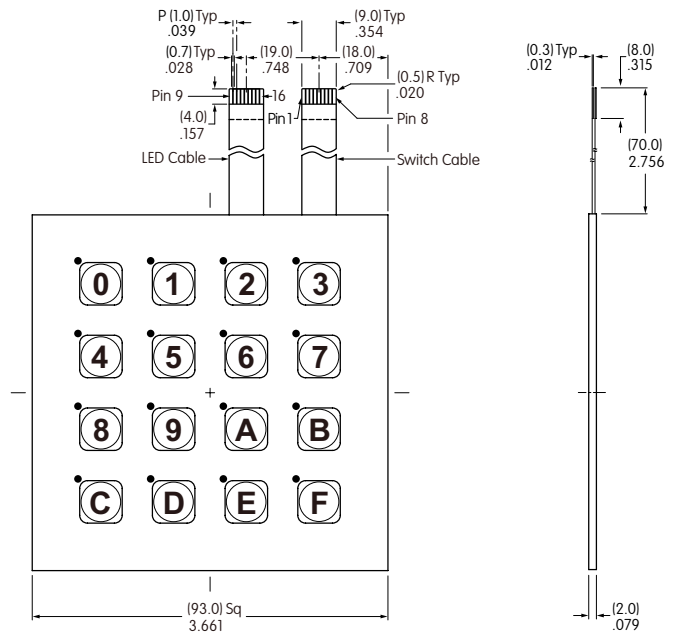

Dot illumination at upper left corner of each keypad

Switch Circuit Matrix For 12 Key

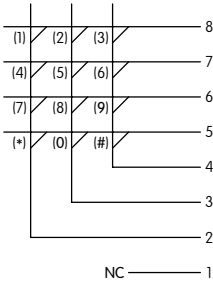

LED Circuit Matrix For 12 Key

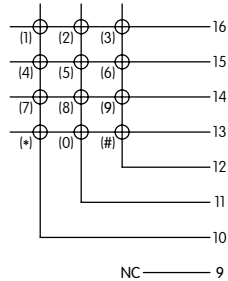

Switch Circuit Matrix For 16 Key

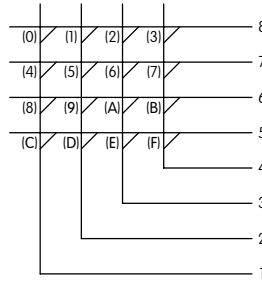

LED Circuit Matrix For 16 Key

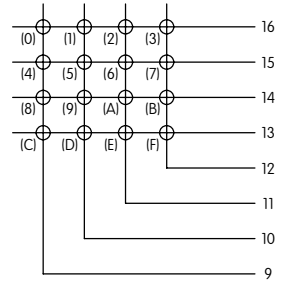

Key numbers in parenthesis are not actually on panel and are for reference only

FMBP12BF



Switch Circuit Matrix Detail For 12 or 16 Key

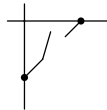

FMBP16BF



LED Circuit Matrix Detail For 12 or 16 Key

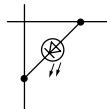

Toggles
Rockers
Pushbuttons
Illuminated PB
Programmable
Keylocks
Rotaries
Slides
Tactiles
Tilt
Touch
Indicators
Accessories
Supplement

Series FM

NEW → **Membranes**

Toggles

Rockers

Pushbuttons

Illuminated PB

Keylocks

Rotaries

Slides

Tactiles

Tilt

Touch

Indicators

Accessories

Supplement

INSERTABLE LEGEND CARDS

Instructions for Customizing Insertable Legends

The membrane keypad assembly comes with three insertable legend cards: yellow, gray and black.

The following provides guidelines for creating and insertion of legend cards for the membrane switch keypad assembly. Read all of the instructions prior to customizing and inserting the legend card.

- Using the borders on the insertable legend card as a guide, be sure characters on the card are about 1.5mm (.059") within these borders. This is the printable area.
- Legend characters may be drawn, printed, etc. Be sure that application choice is completely dry before inserting into membrane keypad assembly.

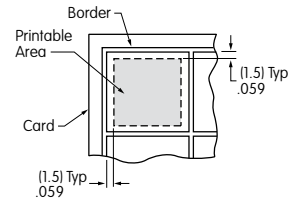

Instructions for Inserting Legend Card

- Note correct orientation of insertable legend card. Insert card under surface sheet, and use caution to avoid bending the membrane keypad assembly. Do not use pointed object to insert card, and do not remove surface sheet.
- Align and center all legend characters within the squares of the surface sheet.
- Smooth any wrinkles or air pockets from surface sheet.
- Peel off adhesive strip from the membrane keypad assembly.
- The legend card is now firmly in place and cannot be removed.
- Detach the protective film.

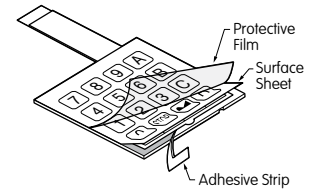
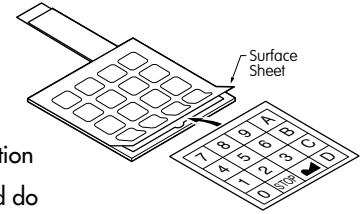

Connectors

Recommended Connectors for 5 Pin

Straight: FCI Part No. SLW5S-5C7LF
 Right Angle: FCI Part No. SLW5R-5C7LF

Recommended Connectors for 8 Pin

Straight: FCI Part No. SLW8S-5C7LF
 Right Angle: FCI Part No. SLW8R-5C7LF

PRECAUTIONS FOR HANDLING

- Assembly of legend card insert is handled by the customer. Therefore, we recommend to evaluate the finished product with the card assembled.
- Nonilluminated products have a loophole on each key. It is possible to add optional illumination by installing appropriate LEDs. Legend card does not have loopholes.
- To test proper electrical operation of switches, use of an electric buzzer is recommended.
- Use an additional chattering prevention circuit for the switch circuit.
- Do not operate switches with pointed objects (i.e. screwdrivers) to prevent perforation of film overlay.
- Use an FPC connector that corresponds to the printed circuit. Contact factory for suitable connectors.
- During assembly and installation of legends place devices on a level, sturdy surface. We do not recommend assembly and installation of device using a free hand or on a soft surface.
- Do not fold, bend, or apply pressure to the product.
- These devices contain adhesive that may emit noise. This does not affect product functionality.
- Do not depress any switch areas during assembly/installation.
- These membrane switches are built with air vents. Prior to installation, make corresponding holes to allow air vents to function. These holes should first be aligned with the membrane switch device, then made on the body of the final installation structure. Do not allow water or oil to penetrate through the air vents. Entry of any liquids through the air vents may cause contact failure.

APPLICATIONS

- Communication equipment
- Office machines
- Electronic equipment for national security
- Automation equipment
- Electronic equipment
- Amusement equipment