

Excellent Integrated System Limited

Stocking Distributor

Click to view price, real time Inventory, Delivery & Lifecycle Information:

[Molex Connector Corporation](#)
[0877582617](#)

For any questions, you can email us directly:

sales@integrated-circuit.com

10 9 8 7 6 5 4 3 2 1

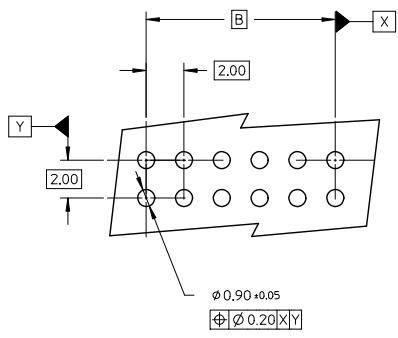
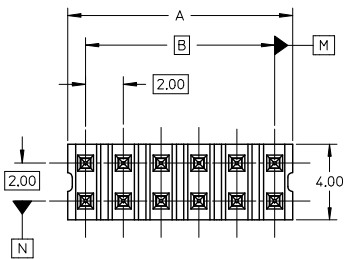

LEGEND
87758-****
CKT SIZE (SEE SHT 2 TABLE) PLATING (SEE NOTE 2)

- NOTES:**
- MATERIAL:
HOUSING: 30% G.F. NYLON 46, 94V-0, COLOR: BLACK
PIN: 0.50mm SQ. PHOSPHOR BRONZE 510
 - PLATING:
 - **16 - 0.38um MIN GOLD IN CONTACT AREA, TIN IN SOLDER AREA, BOTH OVER NICKEL OVERALL.
 - **17 - 0.76um MIN GOLD IN CONTACT AREA, TIN IN SOLDER AREA, BOTH OVER NICKEL OVERALL.
 - **18 - 2.54um MIN TIN OVER NICKEL OVERALL.
 - **19 - 0.05-0.25um GOLD IN CONTACT AREA, TIN IN SOLDER AREA, BOTH OVER NICKEL OVERALL.
 - 12 CKT USED FOR ILLUSTRATION ONLY
 - PACKED IN POCKET TRAY
 - PIN PUSHOUT FORCE: 1KG MIN IN EITHER DIRECTION
 - CKT 4 AND 6 IS CUT FROM CKT 8 AND 12 RESPECTIVELY. CKT 2 ARE CUT FROM ANY LARGER CKT SIZE. ROUGH EDGES ARE EXPECTED ALONG THE CUTTING EDGES.
 - PRODUCT SPEC PS-87761-100 APPLIES.
 - RECOMMENDED PCB THICKNESS IS 1.60±0.10

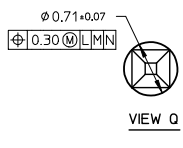
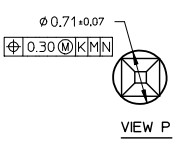
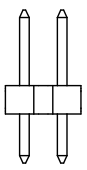
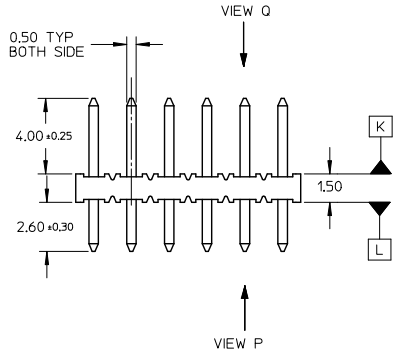

ADD DATUMS EC NO: S2014-0031 DRAWN BY: CHYK-SKANG CHECKED BY: CHYK-SKANG APPR: M LONG 2013/07/08 2013/07/08 2013/07/10	QUALITY SYMBOLS	GENERAL TOLERANCES (UNLESS SPECIFIED)	DIMENSION STYLE	SCALE	DESIGN UNITS	THIRD ANGLE PROJECTION
	$\sqrt{\text{A}}=0$ $\sqrt{\text{B}}=0$ $\sqrt{\text{C}}=0$	mm INCH 4 PLACES ± --- ± --- 3 PLACES ± --- ± --- 2 PLACES ± 0.20 ± --- 1 PLACE ± --- ± --- ANGULAR ± 3 °	MM ONLY	NTS	METRIC	◎ □ THIRD ANGLE PROJECTION
	DRAFT WHERE APPLICABLE MUST REMAIN WITHIN DIMENSIONS	DRAWN BY: KSEE CHECKED BY: KCLING APPROVED BY: SKTOH DATE: 2003/10/30 DATE: 2004/01/05 DATE: 2004/01/05	TITLE: SALES DRAWING 2MM DUAL ROW SINGLE WAFER, VERTICAL T/H HDR	MATERIAL NO. SEE TABLE	DOCUMENT NO. SD-87758-107	SHEET NO. 1 OF 2
	THIS DRAWING CONTAINS INFORMATION THAT IS PROPRIETARY TO MOLEX INCORPORATED AND SHOULD NOT BE USED WITHOUT WRITTEN PERMISSION					

9 8 7 6 5 4 3 2 1

PART NUMBER	CKT SIZE	A	B
87758-02**	2	NA	NA
87758-04**	4	NA	2.00
87758-06**	6	NA	4.00
87758-08**	8	7.90	6.00
87758-10**	10	9.90	8.00
87758-12**	12	11.90	10.00
87758-14**	14	13.90	12.00
87758-16**	16	15.90	14.00
87758-18**	18	17.90	16.00
87758-20**	20	19.90	18.00
87758-22**	22	21.90	20.00
87758-24**	24	23.90	22.00
87758-26**	26	25.90	24.00
87758-28**	28	27.90	26.00
87758-30**	30	29.90	28.00
87758-32**	32	31.90	30.00
87758-34**	34	33.90	32.00
87758-36**	36	35.90	34.00
87758-38**	38	37.90	36.00
87758-40**	40	39.90	38.00
87758-42**	42	41.90	40.00
87758-44**	44	43.90	42.00
87758-46**	46	45.90	44.00
87758-48**	48	47.90	46.00
87758-50**	50	49.90	48.00

CKT SIZE	PART NO. WITH CAP IN TUBE	PART NO. WITH CAP IN TAPE/REEL	PLATING TYPE
8	87758-0814	87758-0815	**16
22	87758-5126	87758-5111	MOLEX INC.

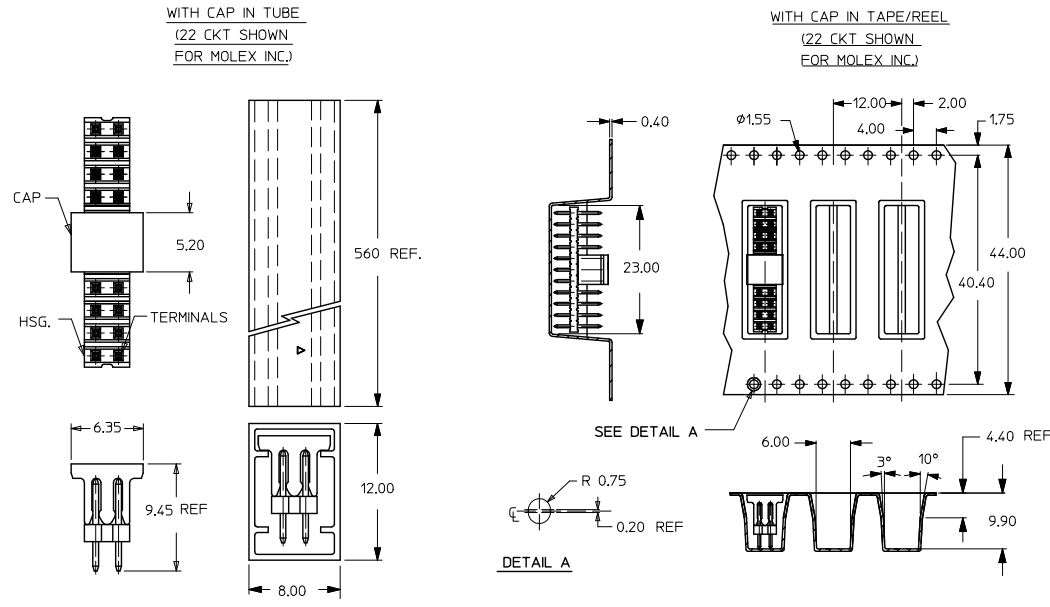

ADD DATUMS EC NO: S2014-0031 DRAWN/ISS: 2013/07/08 CHKD:SKANG APPR:HLONG 2013/07/10	QUALITY SYMBOLS	GENERAL TOLERANCES (UNLESS SPECIFIED)	DIMENSION STYLE	SCALE	DESIGN UNITS	THIRD ANGLE PROJECTION	
	$\nabla=0$ $\nabla=0$ $\nabla=0$	4 PLACES ± --- ± --- 3 PLACES ± --- ± --- 2 PLACES ± 0.20 ± --- 1 PLACE ± --- ± --- ANGULAR ± 3°	MM ONLY	NTS	METRIC		
	DRAWN BY: KSEE DATE: 2003/10/30 CHECKED BY: DATE: APPROVED BY: DATE: 2004/01/05 SKTOH DATE: 2004/01/05	DRAFT WHERE APPLICABLE MUST REMAIN WITHIN DIMENSIONS		MATERIAL NO. SEE TABLE SIZE: A3 THIS DRAWING CONTAINS INFORMATION THAT IS PROPRIETARY TO MOLEX INCORPORATED AND SHOULD NOT BE USED WITHOUT WRITTEN PERMISSION		TITLE: SALES DRAWING 2MM DUAL ROW SINGLE WAFER, VERTICAL T/H HDR MOLEX INCORPORATED DOCUMENT NO. SD-87758-107 SHEET NO. 2 OF 2	
	REV: A4						