

Excellent Integrated System Limited

Stocking Distributor

Click to view price, real time Inventory, Delivery & Lifecycle Information:

[Easy Braid Co.](#)
[EBM8LR401](#)

For any questions, you can email us directly:
sales@integrated-circuit.com



EBM8LR401 Datasheet

Technical Specifications

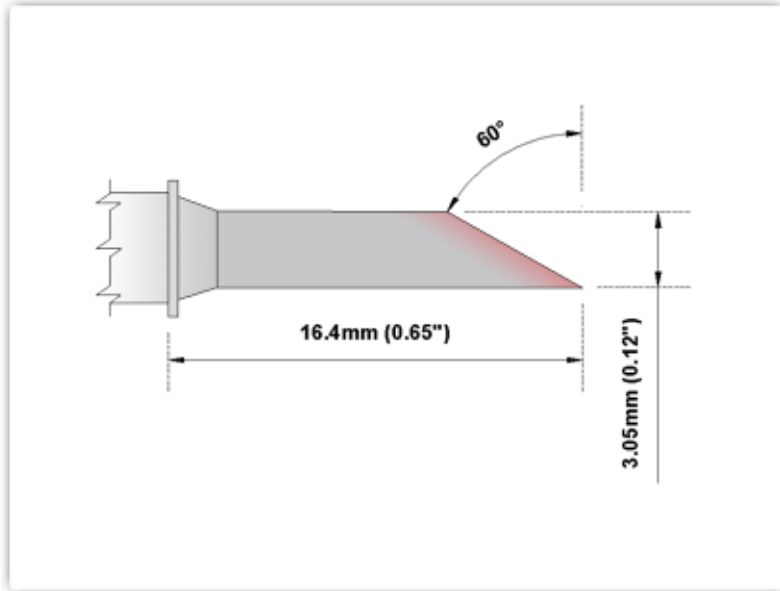

EBM8LR401

Hoof Long Reach 60° 3.05mm (0.12")

Tip Style: Hoof
 Tip Width: 3.05mm (0.12")
 Tip Length: 16.40mm (0.65")

800 Type Cartridge ¹ :	420°C - 475°C
RoHS Compliant ² / Lead Free:	YES
Equivalent to:	SMTC-8170
For Use With:	EB-9000S-1, EB-9000S-2, MX500 and MX5000

Material Composition

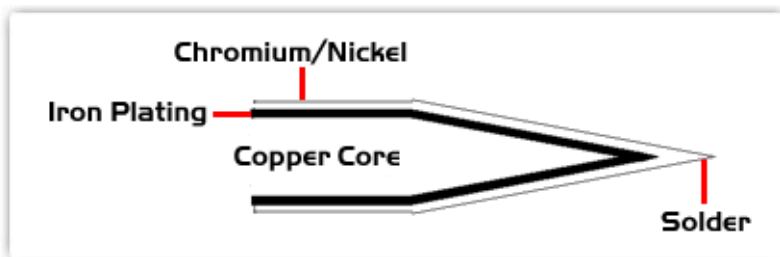

RoHS Compliant
All components are RoHS compliant and Lead-Free.

¹ Easy Braid Co. tip cartridges will typically idle within a temperature range of +/-1.1°C. However, there is variation in idle temperature across tip geometries within an individual temperature series. Easy Braid Co. offers a wide variety of tip geometries from 0.25mm fine point tip to 5mm chisel. The length and geometry of a tip will have an influence on the tip idle temperature. To accurately measure idle temperature it will depend greatly on the measurement method, technique and equipment used. Two different methods or the use of alternative equipment will produce different test results.

² Please refer to <http://www.rohs.gov.uk> for details on RoHS Compliance.