



Excellent Integrated System Limited

Stocking Distributor

Click to view price, real time Inventory, Delivery & Lifecycle Information:

[Amphenol Aerospace Operations](#)
[SJT00RT-10-13P\(014\)](#)

For any questions, you can email us directly:

sales@integrated-circuit.com

Amphenol® SJT Subminiature Cylindrical Connectors

12-091-11



Amphenol

Table of Contents	Page No.
General Information	1
Specifications, Alternate Rotations	2
Insert Availability and Identification	3
Insert Arrangements	4, 5, 6, 7, 8
Crimp	
SJT00RT Wall Mounting Receptacle	9
SJTP00RT Wall Mounting Receptacle, (back panel mounting)	10
SJTP02RE Box Mounting Receptacle, (back panel mounting)	11
SJT06RT Straight Plug/SJTG06RT Straight Plug (with grounding fingers)	12
SJT07RT Jam Nut Receptacle	13
Hermetic	
SJTIY Solder Mounting Receptacle	14
SJT07Y Jam Nut Receptacle	15
Contacts, Sealing Plugs, Plastic Protection Caps	16
Accessories	
Plug Protection Cap/Receptacle Protection Cap	17
Dummy Receptacle, Cable Clamp	18
Application Tools	19
How to Order	20
Sales Office Listing	

Amphenol® SJT

100% scoop-proof junior tri-lock subminiature cylindrical



wall mounting receptacle



straight plug



jam nut receptacle

Amphenol® SJT connectors combine unique design features of the scoop-proof LJT series within standard mounting dimensions of JT types. Available in a wide range of shell sizes, finishes, insert arrangements and accessories, the SJT features:

- **100% scoop-proof design** – basic MIL-DTL-38999 Series I* lengths
- **Standard mounting dimensions** – MIL-DTL-38999, Series III** dimensions
- **Compliance with European Specifications** – PAN6433-2, LN29729, BS9522F0012, VG96912

Components

Shell components are aluminum. Standard plating on shell components is cadmium over nickel with many optional finishes available. Hermetic seal receptacles are available in carbon steel or stainless steel shells. Dependable 5 key/keyway shell polarization with bayonet lock coupling is incorporated to aid and assure positive mating.

Insert material is a high temperature, rigid dielectric polymer providing excellent electrical characteristics. Contrasting letter or number designations are used on insert faces.

A fluorinated silicone interfacial seal is featured on the mating face of pin inserts, assuring complete electrical isolation of pins when connector halves are mated. In addition, a main joint gasket is installed in the receptacles for moisture sealing between connector halves.

Serrated and threaded shells with moisture sealing pilot for back shells accept a wide range of accessories.

Contacts

Standard contact plating is 50 micro inches minimum gold. Power contacts are available in sizes 10, 12, 16, 20, 22, 22M and 22D. Size 8 and 12 twinax contacts are also available. Concentric twinax contact information is available in Amphenol brochure SL-388. All socket contacts are probe proof. Rear insertable/rear release crimp contacts are standard in SJT connectors. High density insert patterns are available.

Coaxial contacts are available in sizes 8, 12 and 16 to accommodate a wide range of coaxial cables. For complete information see Coaxial Contact catalog 12-130.

Optional Features

Special adaptations of the SJT are available for hermetic and high temperature applications. The SJT's high temperature connector is rated at 392°F. SJT hermetic receptacles are described on pages 14 and 15.

Specials

Special types are available, such as connectors less contacts, and circular rack and panel connectors with solderless wrap contacts.

A complete listing of connector types, shell styles and service classes appears on page 20, How to Order. For further information on special application requirements, contact Sidney N.Y.

SJT specifications, alternate rotations

CONTACT RATING

Contact Size	Test Current		Maximum Millivolt Drop Crimp*	Maximum Millivolt Drop Hermetic
	Standard	Hermetic		
22M	3	2	45	60
22D	5	3	73	85
22	5	3	73	85
20	7.5	5	55	60
16	13	10	49	85
12	23	17	42	85
10 Power	33	NA	33	NA

Contact Size	Crimp Well Data	
	Well Diameter	Min. Well Depth
22M	.028 ±.001	.141
22D	.0345 ±.0010	.141
22	.0365 ±.0010	.141
20	.047 ±.001	.209
16	.067 ±.001	.209
12	.100 ±.002	.209
10 (Power)	.137 ±.002	.355

* When using silver plated wire

SERVICE RATING**

Service Rating	Suggested Operating Voltage (Sea Level)		Test Voltage (Sea Level)	Test Voltage 50,000 Ft.	Test Voltage 70,000 Ft.	Test Voltage 110,000 Ft.
	AC(RMS)	DC				
M	400	550	1300 VRMS	550 VRMS	350 VRMS	200 VRMS
N	300	450	1000 VRMS	400 VRMS	260 VRMS	200 VRMS
I	600	850	1800 VRMS	600 VRMS	400 VRMS	200 VRMS
II	900	1250	2300 VRMS	800 VRMS	500 VRMS	200 VRMS

** Please note that the establishment of electrical safety factors is left entirely in the designer's hands, since he is in the best possible position to know what peak voltage, switching surges, transients, etc., can be expected in a particular circuit.

FINISH DATA

Aluminum Shell Components Non-Hermetic		
Finish	Suffix	Indicated Finish Standard for SJT Types
Bright Cadmium Plated Nickel Base		SJT/SJTG
Anodic Coating (Alumilite)	(005)	
Chromate Treated (Iridite 14-2)	(011)	
Olive Drab Cadmium Plate Nickel Base	(014)	
Electroless Nickel Coating	(023)	
Hermetic Connectors		
Carbon Steel Shell, Tin Plated Shell and Contacts		SJT()Y
Stainless Steel Shell, Gold Plated Contacts	Consult Sidney, NY	

SJT ALTERNATE ROTATIONS

A plug with a given rotation letter will mate with a receptacle with the same rotation letter. The AB angle for a given connector is the same whether it contains pins or sockets. Inserts are not rotated in conjunction with the master key/keyway.

AB angles shown are viewed from the front face of the connector. A receptacle is shown at right. The angles for the plug are exactly the same, except the direction of rotation is opposite of that shown for the receptacle.

Master Key/Keyway Rotation

AB ANGLE OF ROTATION (Degrees)

Shell Size	Normal	A	B	C	D
8	95				
10	95	81	67	123	109
12	95	75	63	127	115
14	95	74	61	129	116
16	95	77	65	125	113
18	95	77	65	125	113
20	95	77	65	125	113
22	95	80	69	121	110
24	95	80	69	121	110

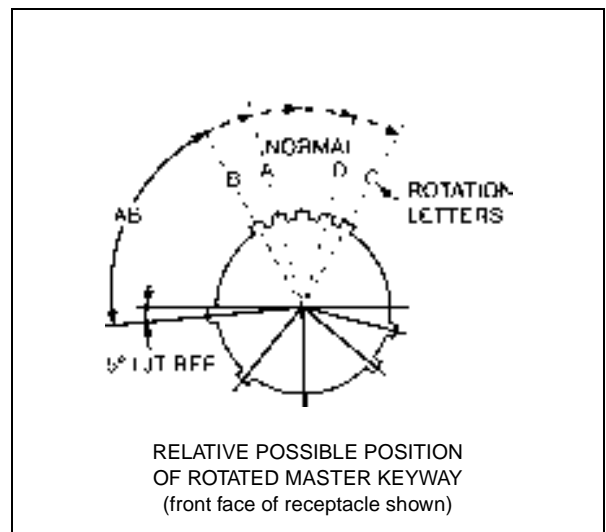

SJT

insert availability and identification

Shell Size	Crimp	Hermetics* Class Y	Service Rating	Total Contacts	Contact Size										
					22D	22M	22	20	16	12	12 (Coax)	10 (Power)	8 (Coax)	8†† (Twinax)	
8-6	X		M	6		6									
8-35	X		M	6	6										
8-44	X		M	4			4								
8-98	X		I	3				3							
10-2	◆		I	2					2						
10-4	◆		I	4					4						
10-5	◆		I	5					5						
10-13	X		M	13		13									
10-35	X		M	13	13										
10-98	X		I	6				6							
12-4	X		I	4					4						
12-8	X		I	8					8						
12-22	X		M	22		22									
12-35	X		M	22	22										
12-98	X	X	I	10				10							
14-5	X		II	5					5						
14-15	X		I	15				14	1						
14-18	X		I	18				18							
14-19	X	X	I	19				19							
14-35	X	X	M	37	37										
14-37	X	X	M	37		37									
14-97	◆		I	12				8	4						
16-2	◆		M	39	38										1**
16-6	X		I	6						6					
16-8	X		II	8					8						
16-13	◆		I	13					13						
16-26	X		I	26				26							
16-35	X		M	55	55										
16-42	◆		M	42			42								
16-55	X		M	55		55									
16-99	X	X	I	23				21	2						
18-11	X		II	11					11						
18-32	X		I	32				32							
18-35	X	X	M	66	66										
18-66	X	X	M	66		66									
20-1	X	X	M	79		79									
20-2	X		M	65			65								
20-11	◆		I	11						11					
20-16	X		II	16					16						
20-35	X	X	M	79	79										
20-39	X		I	39				37	2						
20-41	X		I	41				41							
20-75	◆		M	4										4††	
20-79	◆		II	19	17									2†	
22-1	X	X	M	100		100									
22-2	X		M	85			85								
22-21	X		II	21					21						
22-35	X	X	M	100	100										
22-53	X		I	53				53							
24-1	X		M	128		128									
24-2	X		M	100			100								
24-4	X		I	56					48	8					
24-7	◆		M	99	97										2**
24-11	◆		N	11				2				9			
24-19	◆		I	19						19					
24-20	◆		N	30				10	13***		4				3
24-24	X		I	24					12	12					
24-29	X		I	29					29						
24-35	X		M	128	128										
24-37	◆		I	37					37						
24-43	◆		I	43				23	20						
24-46	◆		I	46				40	4					2††	
24-61	X		I	61				61							

◆ not tooled for 02-RE

* Pin inserts only (contact Sidney, NY for socket availability).

** twinax contacts for MIL-C-17/176-00002 cable.

*** Two size 16 contacts dedicated to fiber optics. Consult Sidney, NY or Catalog Section 12-352 for fiber optic information.

† must be ordered separately





†† Coax Contacts for RG180 or RG195 cable.





††† Size 8 Coax and Twinax are interchangeable.
 For availability of size 12 twinax contacts, consult Amphenol, Sidney, NY





SJT





insert arrangements

front face of pin inserts illustrated

					
Insert Arrangement	8-6	8-35	8-44	8-98	10-2
Service Rating	M	M	M	I	I
Number of Contacts	6	6	4	3	2
Contact Size	22M	22D	22	20	16

					
Insert Arrangement	10-4	10-5	10-13	10-35	10-98
Service Rating	I	I	M	M	I
Number of Contacts	4	5	13	13	6
Contact Size	20	20	22M	22D	20

					
Insert Arrangement	12-4	12-8	12-22	12-35	12-98
Service Rating	I	I	M	M	I
Number of Contacts	4	8	22	22	10
Contact Size	16	20	22M	22D	20











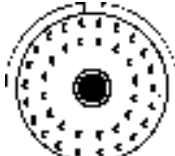

					
Insert Arrangement	14-5	14-15	14-18	14-19	14-35
Service Rating	II	I	I	I	M
Number of Contacts	5	14 1	18	19	37
Contact Size	16	20 16	20	20	22D

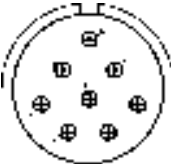
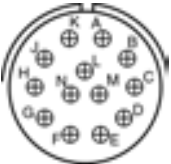

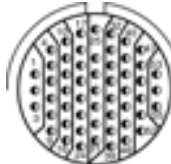
SJT

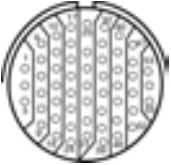
insert arrangements

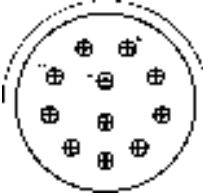
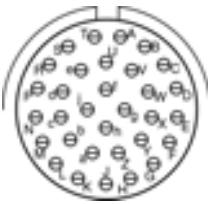
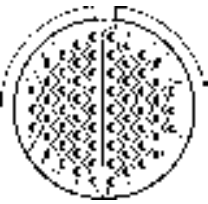
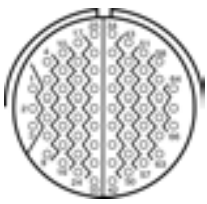
front face of pin inserts illustrated

				
Insert Arrangement	14-37	14-97	16-2	16-6
Service Rating	M	I	M	I
Number of Contacts	37	8 4	38 1	6
Contact Size	22M	20 16	22D 8 Twinax	12
				
Insert Arrangement	16-8	16-13	16-26	16-35
Service Rating	II	I	I	M
Number of Contacts	8	13	26	55
Contact Size	16	16	20	22D
				
Insert Arrangement	16-42	16-55	16-99	18-11
Service Rating	M	M	I	II
Number of Contacts	42	55	21 2	11
Contact Size	22	22M	20 16	16
				
Insert Arrangement	18-32	18-35	18-66	20-1
Service Rating	I	M	M	M
Number of Contacts	32	66	66	79
Contact Size	20	22D	22M	22M

SJT

insert arrangements

front face of pin inserts illustrated

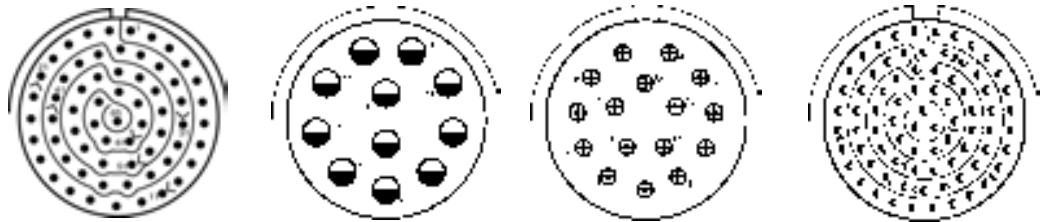

Insert Arrangement	20-2	20-11	20-16	20-35
Service Rating	M	I	II	M
Number of Contacts	65	11	16	79
Contact Size	22	12	16	22D

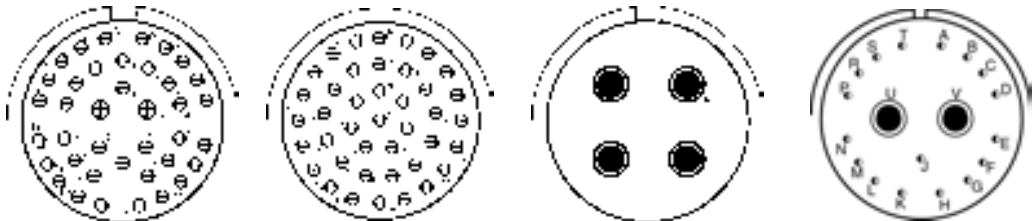

Insert Arrangement	20-39	20-41	20-75	20-79
Service Rating	I	I	M	II
Number of Contacts	37 2	41	4	17 2
Contact Size	20 16	20	8 Coax ^{††}	22 8 Coax [†]

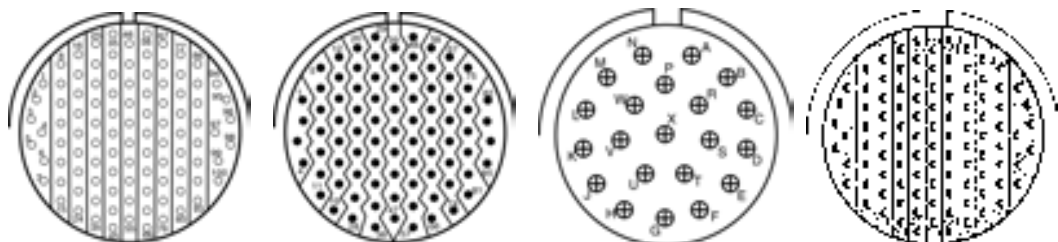

Insert Arrangements	22-1	22-2	22-21	22-35
Service Rating	M	M	II	M
Number of Contacts	100	85	21	100
Contact Size	22M	22	16	22D

[†] must be ordered separately
^{††} coax contacts for RG180 or RG195 cable



SJT

insert arrangements

front face of pin inserts illustrated

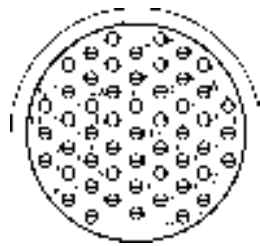

22-53
I
53
20



24-1
M
128
22M

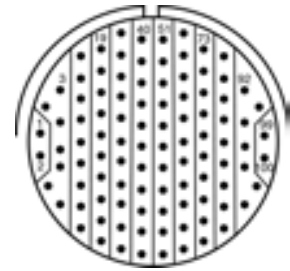

24-2
M
100
22

Insert Arrangement
Service Rating
Number of Contacts
Contact Size

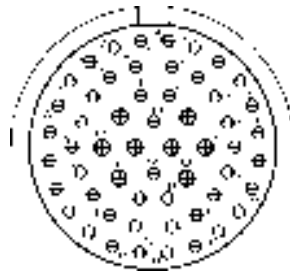

24-4
I
48 8
20 16

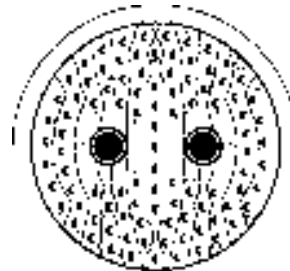

24-7
M
97 2
22D 8 Twinax

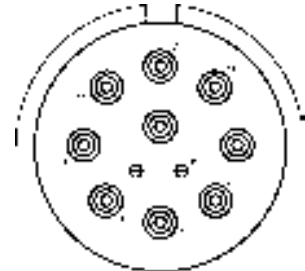

24-11
N
2 9
20 10 Power

Insert Arrangement
Service Rating
Number of Contacts
Contact Size

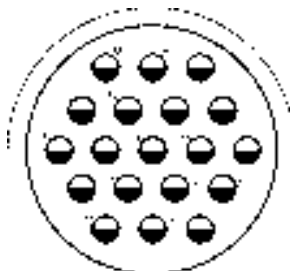

24-19
I
19
12

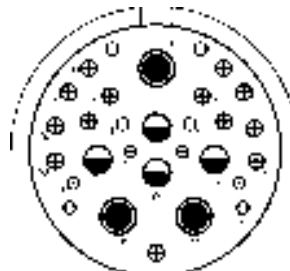

24-20
N
10 13 3 4
20 16 8 Twinax 12 Coax

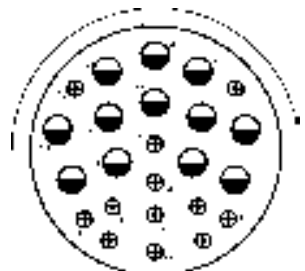

24-24
I
16 12
16 12

Insert Arrangement
Service Rating
Number of Contacts
Contact Size

SJT

insert arrangements

front face of pin inserts illustrated

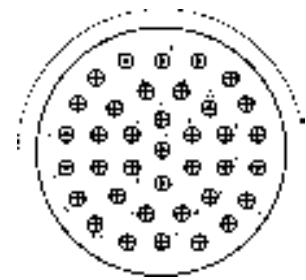
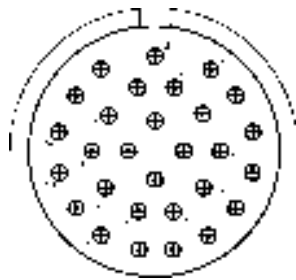

Insert Arrangement
 Service Rating
 Number of Contacts
 Contact Size

24-29
 I
 29
 16

24-35
 M
 128
 22D

24-37
 I
 37
 16

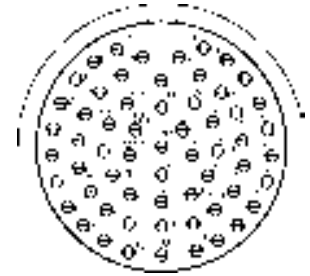
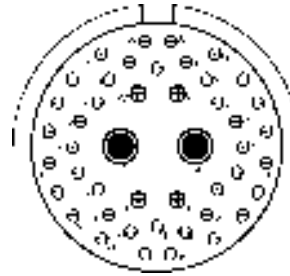
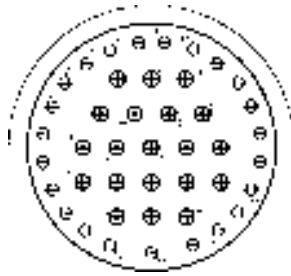

Insert Arrangement
 Service Rating
 Number of Contacts
 Contact Size

24-43
 I
 23 20
 20 16

24-46
 I
 40 4 2
 20 16 8 Coax^{††}

24-61
 I
 61
 20

^{††} coax contacts for RG180 or RG195 cable



SJT00RT- crimp wall mounting receptacle

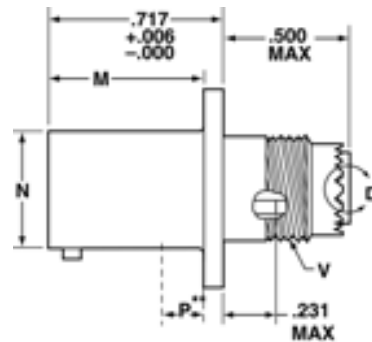
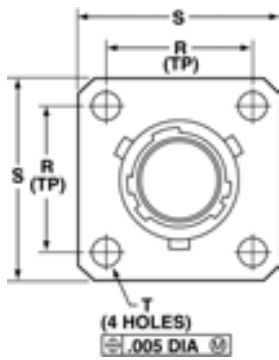

*SJT00RT-XX-XXX

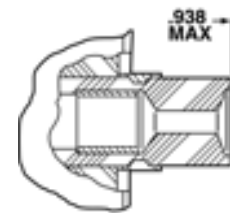

VIEW D ENLARGED
FOR COAXIAL USE ONLY

* To complete order number, see page 20

** Standard wall mount may be back panel mounted where panel thickness does not exceed these dimensions. For thicker panel applications, SJTP00RT should be used, page 10.

Shell Size	L Max	M +.000 -.005	R (TP)	S ±.016	T ±.005	V Thread Modified		N +.001 -.005	P** Max
						Class 2A UNEF (Plated)	Modified Major Dia.		
8	.500	.632	.594	.812	.120	.4375-28	.421 – .417	.473	.117
10	.500	.632	.719	.938	.120	.5625-24	.542 – .538	.590	.117
12	.500	.632	.812	1.031	.120	.6875-24	.667 – .663	.750	.117
14	.500	.632	.906	1.125	.120	.8125-20	.791 – .787	.875	.117
16	.500	.632	.969	1.219	.120	.9375-20	.916 – .912	1.000	.117
18	.500	.632	1.062	1.312	.120	1.0625-18	1.034 – 1.030	1.125	.117
20	.500	.602	1.156	1.438	.120	1.1875-18	1.158 – 1.154	1.250	.087
22	.500	.602	1.250	1.562	.120	1.3125-18	1.283 – 1.279	1.375	.087
24	.550	.602	1.375	1.688	.147	1.4375-18	1.408 – 1.404	1.500	.055

All dimensions for reference only.

SJTP00RT – crimp wall mounting receptacle (back panel mounting)

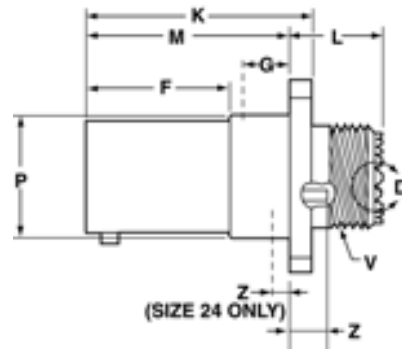
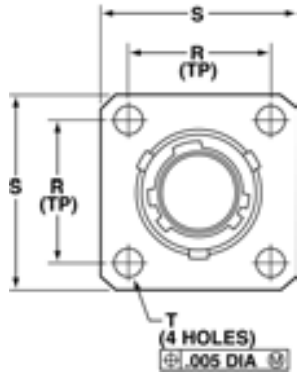

*SJTP00RT-XX-XXX

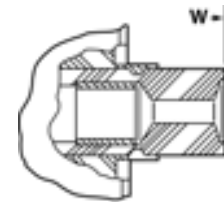

VIEW D ENLARGED FOR COAXIAL USE ONLY

* To complete order number, see page 20

Shell Size	F +.000 -.005	K +.006 -.000	L Max.	M +.000 -.005	R (TP)	S +.011 -.010	T ±.005	Z ±.031	V Thread Class 2A (Plated) UNEF	P Dia. +.001 -.005	W Max.	G Max.
8	.609	.945	.539	.860	.594	.812	.120	.062	.4375-28	.516	.812	.345
10	.609	.945	.539	.860	.719	.938	.120	.062	.5625-24	.633	.812	.345
12	.609	.945	.539	.860	.812	1.031	.120	.062	.6875-24	.802	.812	.345
14	.609	.945	.539	.860	.906	1.125	.120	.062	.8125-20	.927	.812	.345
16	.609	.945	.539	.860	.969	1.219	.120	.062	.9375-20	1.052	.812	.345
18	.609	.945	.539	.860	1.062	1.312	.120	.062	1.0625-18	1.177	.812	.345
20	.609	.945	.539	.860	1.156	1.438	.120	.062	1.1875-18	1.302	.812	.345
22	.609	.945	.539	.860	1.250	1.562	.120	.062	1.3125-18	1.427	.812	.345
24	.750	1.085	.493	1.000	1.375	1.688	.147	.078	1.4375-18	1.552	.781	.452

All dimensions for reference only.

SJTP02RE – crimp box mounting receptacle (back panel mounting)

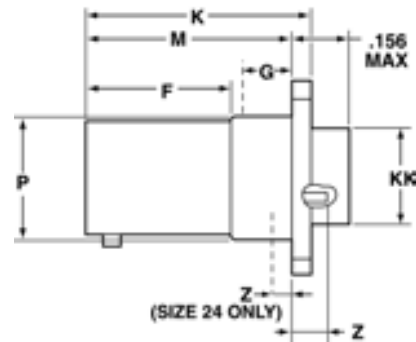
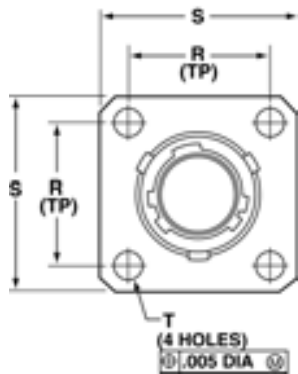

*SJTP02RE-XX-XXX

* To complete order number, see page 20

Shell Size	F	K	M	R (TP)	S	T	Z	P Dia.	KK Dia.	G Max.
8	.609	.945	.860	.594	.812	.120	.062	.516	.417	.345
10	.609	.945	.860	.719	.938	.120	.062	.633	.538	.345
12	.609	.945	.860	.812	1.031	.120	.062	.802	.663	.345
14	.609	.945	.860	.906	1.125	.120	.062	.927	.787	.345
16	.609	.945	.860	.969	1.219	.120	.062	1.052	.912	.345
18	.609	.945	.860	1.062	1.312	.120	.062	1.177	1.030	.345
20	.609	.945	.860	1.156	1.438	.120	.062	1.302	1.154	.345
22	.609	.945	.860	1.250	1.562	.120	.062	1.427	1.279	.345
24	.750	1.085	1.000	1.375	1.688	.147	.078	1.552	1.404	.452

All dimensions for reference only.

SJT06RT/SJTG06RT – crimp straight plug/straight plug (with grounding fingers)

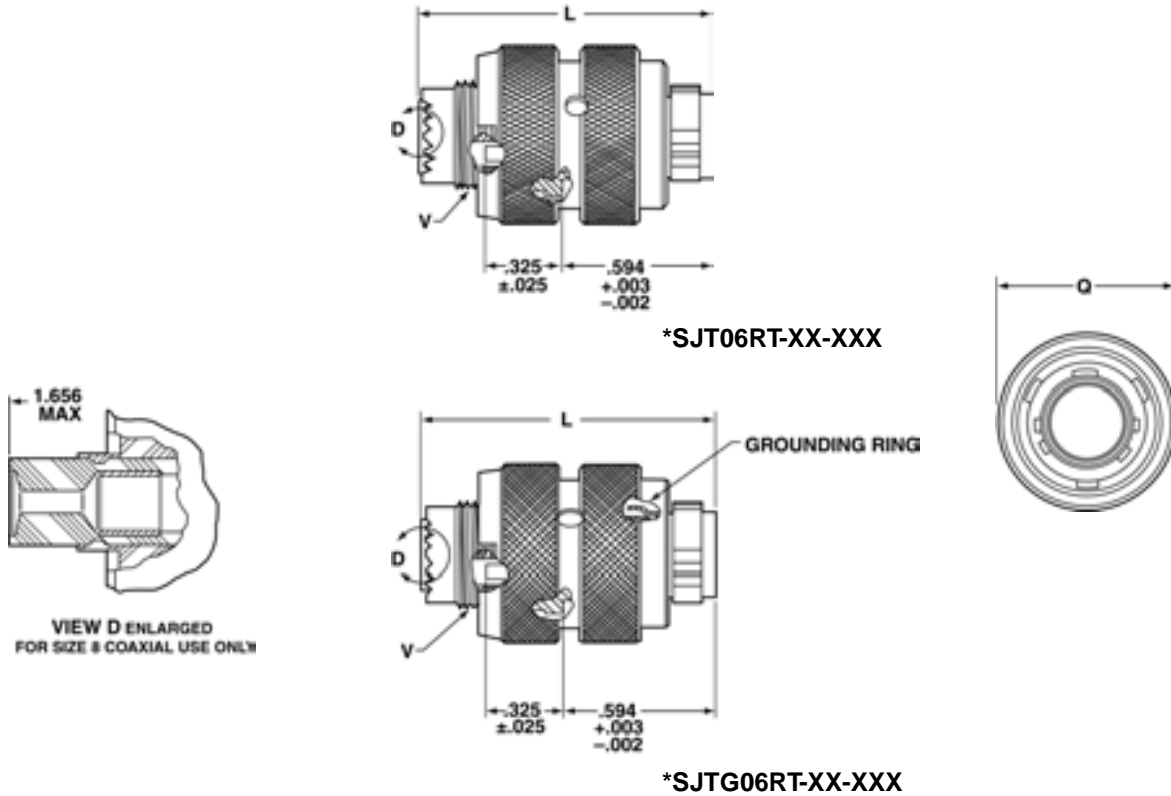

* To complete order, see page 20

Shell Size	L Max	Q Dia. Max.	V Thread	
			Class 2A UNEF (Plated)	Modified Major Dia.
8	1.219	.734	.4375-28	.421 – .417
10	1.219	.844	.5625-24	.542 – .538
12	1.219	1.016	.6875-24	.667 – .663
14	1.219	1.141	.8125-20	.791 – .787
16	1.219	1.265	.9375-20	.916 – .912
18	1.219	1.391	1.0625-18	1.034 – 1.030
20	1.219	1.500	1.1875-18	1.158 – 1.154
22	1.219	1.625	1.3125-18	1.283 – 1.279
24	1.258	1.750	1.4375-18	1.408 – 1.404

All dimensions for reference only.

SJT07RT – crimp jam nut receptacle

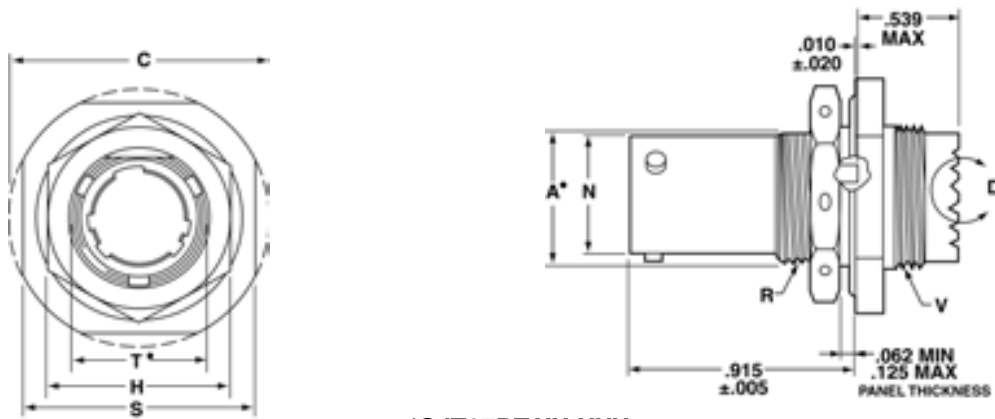

*SJT07RT-XX-XXX

- "D" shaped panel cut-out dimensions
- * To complete order number, see page 20
- ** Oversize threads. Check accessory threads before ordering

Shell Size	A* +.000 -.010	H Hex +.017 -.016	S ±.016	V Thread Class 2A UNEF (Plated)	R Thread Class 2A UNEF (Plated)	N +.001 -.005	C Max.	T* +.010 -.000
8	.542	.750	.938	.5625-24	.5625-24	.473	1.078	.572
10	.669	.875	1.062	.6875-24	.6875-24	.590	1.203	.697
12	.830	1.062	1.250	.8125-20	.8750-20	.750	1.391	.884
14	.955	1.188	1.375	.9375-20	1.0000-20	.875	1.515	1.007
16	1.084	1.312	1.500	1.0625-18	1.1250-18	1.000	1.641	1.134
18	1.208	1.438	1.625	1.1875-18	1.2500-18	1.125	1.766	1.259
20	1.333	1.562	1.812	1.3125-18	1.3750-18	1.250	1.953	1.384
22	1.459	1.688	1.938	1.4375-18	1.5000-18	1.375	2.078	1.507
24	1.580	1.812	2.062	1.4375-18	1.6250-18	1.500	2.203	1.634

All dimensions for reference only.

SJT1Y – hermetic solder mounting receptacle

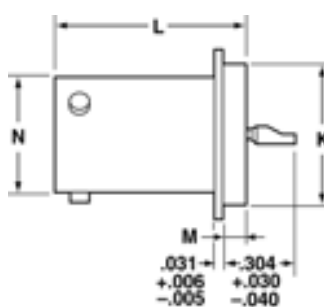

*SJT1Y-XX-XXX

* To complete order, see page 20

Shell Size	L	M	G Dia.	K Dia.	N
8	+.011 -.000	+.006 -.005	+.011 -.010	+.001 -.005	+.001 -.005
10	.789	.125	.687	.562	.473
12	.789	.125	.797	.672	.590
14	.789	.125	.906	.781	.750
16	.789	.125	1.031	.906	.875
18	.789	.125	1.156	1.031	1.000
20	.789	.125	1.281	1.156	1.125
22	.789	.125	1.375	1.250	1.250
24	.821	.156	1.500	1.375	1.375
24	.821	.156	1.625	1.500	1.500

All dimensions for reference only.

SJT07Y – hermetic jam nut receptacle

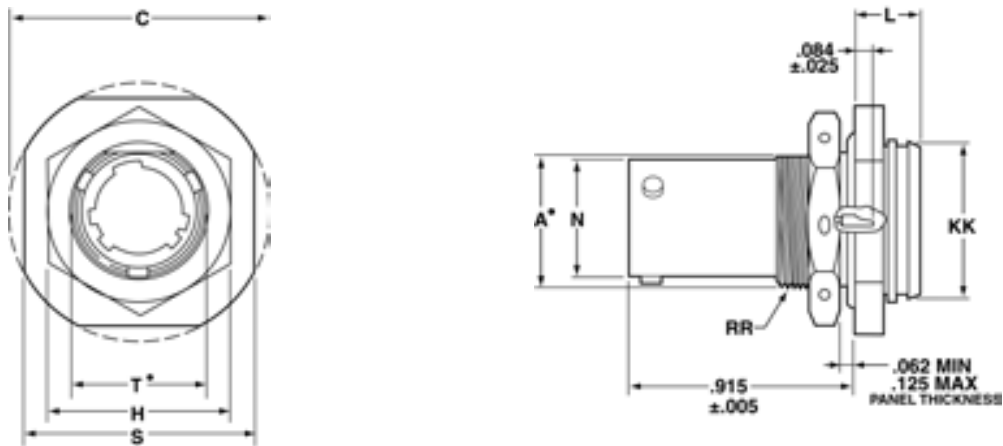

*SJT07Y-XX-XXX

- "D" shaped panel cut-out dimensions
- * To complete order number, see page 20

Shell Size	N +.001 -.005	C Max.	A* +.000 -.010	L Max.	H Hex +.017 -.016	S ±.016	KK +.011 -.000	RR Thread Class 2A UNEF (Plated)	T* +.010 -.000
8	.473	1.078	.542	.297	.750	.938	.642	.5625-24	.572
10	.590	1.203	.669	.297	.875	1.062	.766	.6875-24	.697
12	.750	1.391	.830	.297	1.062	1.250	.892	.8750-20	.884
14	.875	1.515	.955	.297	1.188	1.375	1.018	1.0000-20	1.007
16	1.000	1.641	1.084	.297	1.312	1.500	1.142	1.1250-18	1.134
18	1.125	1.766	1.208	.328	1.438	1.625	1.268	1.2500-18	1.259
20	1.250	1.953	1.333	.328	1.562	1.812	1.392	1.3750-18	1.384
22	1.375	2.078	1.459	.328	1.688	1.938	1.518	1.5000-18	1.507
24	1.500	2.203	1.580	.328	1.812	2.062	1.642	1.6250-18	1.634

All dimensions for reference only.

SJT

contacts, sealing plugs, plastic protection caps

CONTACTS & SEALING PLUGS

Contact Size	SJT Pins	SJT Sockets	Sealing Plugs
8 (Coax)	21-33102-21**	21-33101-21**	10-482099-8
8 (Twinax)	21-33190-529†	21-33191-530†	10-482099-8
10 (Power)	10-251415-105	10-407035-105	Not Available
12	10-251415-12H	10-407035-125	10-405996-12 Yellow
16	10-251415-165	10-407035-165	10-405996-16 Blue
20	10-251415-205	10-407035-205 10-497403-205††	10-405996-20 Red
22*	10-251415-225	10-407035-225	10-405996-22 Black
22M*	10-251415-235	10-407035-235	10-405996-22 Black
22D	10-251415-725	10-407035-725	10-405996-22 Black

Above part numbers include standard finish designation – gold plating over suitable underplate in accordance with MIL-C-39029. For other finish variations, consult Amphenol, Sidney, NY.

* Inactive for new design.

** 21-33102-21 and 21-33101-21 are for use with RG180B/U and RG195A/U cable. For other size 8 coax or optional sizes 12 and 16 coax contacts available for use in SJT connectors, see catalog 12-130 or consult Amphenol, Sidney, NY.

† 21-33190-529 and 21-33191-530 are for use with M17/176-00002 cable.

†† Optional design – see slash sheet MS39029.

For other contact options available for use in SJT connectors, (wire-wrap, thermocouple, fiber optic) consult Amphenol, Sidney, NY.

PLASTIC PROTECTION CAPS

Shell Size	Plug	Receptacle
8	10-70500-10	10-70506-10S
10	10-70500-14	10-70506-12
12	10-70500-16	10-70506-14
14	10-70500-18	10-70506-16
16	10-70500-20	10-70506-18
18	10-70500-22	10-70506-20
20	10-70500-24	10-70506-22
22	10-70524-1	10-70506-24
24	10-70506-28	10-70524-1

SJT – accessories

plug protection cap/receptacle protection cap

PLUG PROTECTION CAP

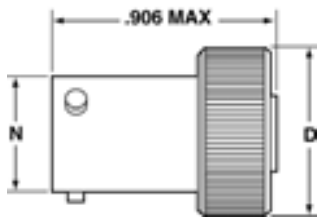

***10-476801-XXX**

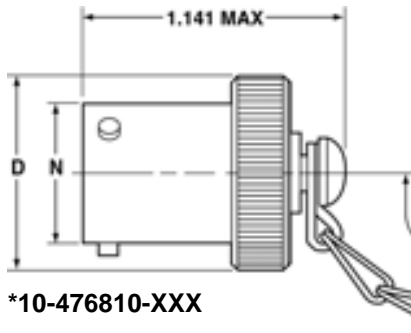

***10-476810-XXX**

RECEPTACLE PROTECTION CAP

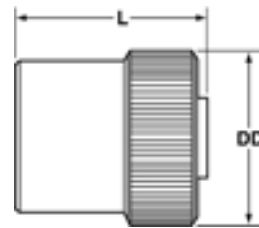

***10-325943-XXX**

*To complete order number, add shell size and suffix number. For example, shell size 10 with bright cadmium plated nickel base, 10-476810-107.

Plug Shell Size	D Dia. Max.	N Dia. +.001 - .005
8	.688	.473
10	.812	.590
12	.969	.750
14	1.094	.875
16	1.219	1.000
18	1.344	1.125
20	1.469	1.250
22	1.594	1.375
24	1.719	1.500

*To complete order number, add shell size and suffix number. For example, shell size 10 with bright cadmium plated nickel base, 10-325943-107.

Receptacle Shell Size	DD Dia. Max.	L Max.
8	.734	.828
10	.844	.828
12	1.016	.828
14	1.141	.828
16	1.265	.828
18	1.391	.828
20	1.500	.828
22	1.625	.828
24	1.750	.859

Finish	Suffix
Bright Cadmium Plated Nickel Base	XX7
Anodic Coating (Alumilite)	XX5
Chromate Treated (Iridite 14-2)	XX0
Olive Drab Cadmium Plate Nickel Base	XX9
Electroless Nickel Coating	XXG

All dimensions for reference only

SJT – accessories

dummy receptacle, cable clamp

DUMMY RECEPTACLE

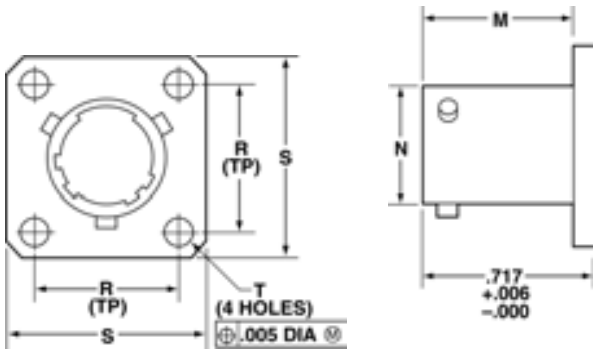

*10-476807-XXX

Finish	Suffix
Bright Cadmium Plated Nickel Base	XX7
Anodic Coating (Alumilite)	XX5
Chromate Treated (Iridite 14-2)	XX0
Olive Drab Cadmium Plate Nickel Base	XX9
Electroless Nickel Coating	XXG

* To complete order number, add shell size and suffix number. For example, shell size 10 with bright cadmium plated nickel base, 10-476807-107.

Dummy Receptacle Shell Size	D Dia. Max.	L Max.
8	.734	.828
10	.844	.828
12	1.016	.828
14	1.141	.828
16	1.265	.828
18	1.391	.828
20	1.500	.828
22	1.625	.828
24	1.750	.859

All dimensions for reference only

CABLE CLAMP

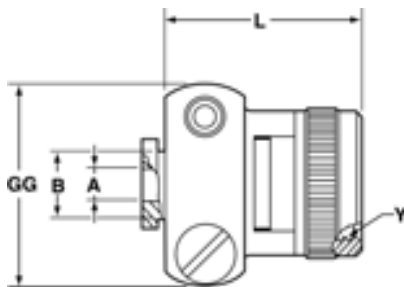

*10-476808-XXX

Finish	Suffix
Bright Cadmium Plated Nickel Base	XX7
Anodic Coating (Alumilite)	XX5
Chromate Treated (Iridite 14-2)	XX0
Olive Drab Cadmium Plate Nickel Base	XX9
Electroless Nickel Coating	XXG

* To complete order number, add shell size and suffix number. For example, shell size 10 with bright cadmium plated nickel base, 10-476808-107.

Cable Clamp Shell Size	A Dia. +.010 - .025	B Dia. +.000 - .011	L Max.	Y Thread Class 2B UNEF (Plated)	GG Max.
8	.125	.250	.922	.4375-28	.775
10	.188	.312	.922	.5625-24	.837
12	.312	.438	.922	.6875-24	.963
14	.375	.562	1.172	.8125-20	1.087
16	.500	.625	1.172	.9375-20	1.150
18	.625	.750	1.172	1.0625-18	1.400
20	.625	.750	1.172	1.1875-18	1.400
22	.750	.938	1.297	1.3125-18	1.587
24	.800	1.000	1.297	1.4375-18	1.681

All dimensions for reference only

SJT application tools

The following data includes information pertaining to the application tools which have been established for crimping, inserting, and removing contacts incorporated in the SJT.

For additional information on coaxial contact tools, see catalog 12-130.

All crimping tools included are the "full cycling" type and when used as specified in the installation instructions (L-624) covering the SJT series connectors, will provide reliable crimped wire to contact terminations. There is a possibility of additional crimping tools other than those included being available at present or in the future for this specific application.

CRIMPING TOOLS

Contact Size/Type	Crimping Tool	Turret Die or Positioner
12 Pin and Socket	M22520/1-01	M22520/1-04
16 Pin and Socket	M22520/1-01 M22520/7-01	M22520/1-04 M22520/7-04
20 Pin and Socket	M22520/1-01 M22520/2-01 M22520/7-01	M22520/1-04 M22520/2-10 M22520/7-08
22, 22D, 22M Pin	M22520/2-01 M22520/7-01	M22520/2-09 M22520/7-07
22, 22D, 22M Socket (LJT-R)	M22520/2-01 M22520/7-01	M22520/2-07 M22520/7-05
8 Twinax Center Pin and Socket	M22520/2-01	M22520/2-37
8 Twinax Intermediate Outer Pin & Socket	M22520/5-01	M22520/5-200

Contact Size/Type	Crimping Tool	Turret Die or Positioner
8 Coaxial Inner Pin and Socket	M22520/2-01	M22520/2-31
8 Coaxial Outer Pin and Socket	M22520/5-01	M22520/5-05 Die Closure B
	M22520/5-01	M22520/5-41 Die Closure B
	M22520/10-01	M22520/10-07 Die Closure B
16 Coaxial Inner Pin and Socket	M22520/2-01	M22520/2-35
16 Coaxial Outer Pin and Socket	M22520/4-01	M22520/4-02
12 Coaxial Inner Pin and Socket	M22520/2-01	M22520/2-34
12 Coaxial Outer Pin and Socket	M22520/31-01	M22520/31-02
10 (Power)	***	***

Where 2 or 3 tools are listed for a contact size, only one tool and its die or positioner are required to crimp the contact. The above crimping tools and positioners are available from the approved tool manufacturer.

INSERTION TOOLS

Use With Contact Size	Plastic Tools		Metal Tools			
	MS Part Number	Color	Angle Type		Straight Type Proprietary Part Number	Color
			MS Part Number	Proprietary Part Number		
10 (Power)	M81969/14-05*	Gray/(White)	M81969/8-11	†	†	Green
12	M81969/14-04*	Yellow/(White)	M81969/8-09	11-8674-12	11-8794-12	Yellow
16	M81969/14-03*	Blue/(White)	M81969/8-07	11-8674-16	11-8794-16	Blue
20	M81969/14-10*	Red/(Orange)	M81969/8-05	11-8674-20	11-8794-20	Red
22	M81969/14-09*	Brown/(White)	M81969/8-03	11-8674-22	11-8794-22	Brown
22D, 22M	M81969/14-01*	Green/(White)	M81969/8-01	11-8674-24	11-8794-22	Brown
8 Coaxial	None Required					
8 Twinax	None		M81969/46-06**	None		Red

REMOVAL TOOLS

Use With Contact Size	Plastic Tools		Metal Tools				
	MS Part Number	Color Code	For Unwired Contacts Proprietary Part Number	Angle Type		Straight Type Proprietary Part Number	Color Code
				MS Part Number	Proprietary Part Number		
10 (Power)	M81969/14-05*	(Green)/White	†	M81969/8-12	†	†	Green/White
12	M81969/14-04*	(Yellow)/White	11-10050-11	M81969/8-10	11-8675-12	11-8795-12	Yellow/White
16	M81969/14-03*	(Blue)/White	11-10050-10	M81969/8-08	11-8675-16	11-8795-16	Blue/White
20	M81969/14-10*	Orange	11-10050-9	M81969/8-06	11-8675-20	11-8795-20	Red/White
22	M81969/14-09*	(Brown)/White	11-10050-8	M81969/8-04	11-8675-22	11-8795-22	Brown/White
22D, 22M	M81969/14-01*	(Green)/White	11-10050-7	M81969/8-02	11-8675-24	11-8795-24	Green/White
8 Coaxial	M81969/14-12	Green	None	None	11-9170	DRK264-8††	N/A
8 Twinax	M81969/14-12	Green	None	M81969/46-12**	11-9170	N/A	N/A

The M81969/8, 11-8674, 11-8675, and 11-8794 metal contact insertion and removal tools will accommodate wires having the maximum outside diameter as follows: Contact size 12-.155, 16-.109, 20-.077, 22, 22D, 22M-.050. When wire diameters exceed those specified, the plastic tools must be used.

* Double ended insertion/removal tool.

** Twinax insertion tools are available only in a straight type, metal version.

*** For size 10 power contact application tools, consult Amphenol, Sidney, NY.

† To be determined.

†† Contact Daniels Manufacturing Co. for availability.

SJT

how to order

PART NUMBER

To more easily illustrate ordering procedure, part number SJT00RT-18-66PA() is shown as follows:

<u>SJT</u>	<u>00</u>	<u>RT</u>	-	<u>18</u>	-	<u>66</u>	<u>P</u>	<u>A</u>	<u>()</u>
1	2	3		4		5	6	7	8

See code below:

1. Connector Type:
 SJT designates standard scoop-proof Junior Tri-Lock Connector
 SJTS designates high temperature connector
 SJTG designates plug with grounding fingers
 SJTP designates back panel mounted
2. Shell Style:
 00 designates wall mount receptacle
 06 designates straight plug
 07 designates jam nut receptacle
 I designates solder mount receptacle – hermetic
3. Service Class:
 “Y” for hermetic applications. . . fused compression glass sealed inserts. Leakage rate less than 1.0×10^{-6} cc/sec. at 15 psi differential; with interfacial seal.
 “RT” for environmental applications – supplied without rear accessories. Design provides serrations on rear threads of shells with moisture sealing pilot for back shells.
 For additional information defining complete description of service class, consult Amphenol, Sidney, NY.
4. SJT shell sizes available from 8 through 24.
5. 18-66 designates insert arrangement. Refer to pages 3 through 8 for insert pattern availability.
6. “P” designates pin contacts; “S” for socket contacts.
7. “A” designates alternate keying. Other basic rotations are “B”, “C” and “D”. No letter required for normal (no rotation) position. (see page 2)
8. Finish variation suffix. (Page 2).