

Excellent Integrated System Limited

Stocking Distributor

Click to view price, real time Inventory, Delivery & Lifecycle Information:

[Weidmüller](#)
[1638180000](#)

For any questions, you can email us directly:

sales@integrated-circuit.com

Product catalogue | PCB connection systems | PCB plug-in connectors | Pitch 5.00 / 5.08 mm (0.197 / 0.200 inch) | Socket connectors, tension clamp connection, pitch 5.00/5.08 | BLZ 5.00-5.08/90/270 | BLZ 5.00/270B

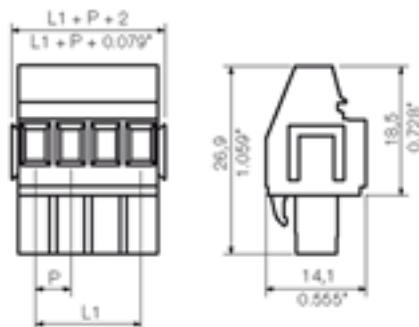

General ordering data

Order No.	1638180000
Part designation	BLZ 5.00/16/270B SN OR
Version	PCB plug-in connector, Female connectors, Clamping yoke connection, Clamping range, max.: 3.31 mm ² , Pitch: 5.00 mm, No. of poles: 16, 270°, Box
EAN	4008190275440
Qty.	18 pc(s).

System parameters

Conductor connection system	Clamping yoke connection
Outgoing direction of conductor	270°
Pitch	5 mm
Pitch in inch	0.197 inch
No. of poles	16
No. of rows	1
Screwdriver blade	0.6 x 3.5
Screwdriver blade standard	DIN 5264
Tightening torque, min.	0.4 Nm
Tightening torque, max.	0.5 Nm
Clamping screw	M 2.5
Stripping length	7 mm
L1 in mm	75 mm
L1 in inch	2.953 inch
Electric shock protection to DIN VDE 0470	IP 20
Electric shock protection to DIN VDE 0470	Safe from finger touch

Material data

Insulating material	PBT
Colour	orange
colour chart	Similar to RAL 2000
Insulating material group	IIIa
Flammability class UL 94	V-0
CTI	>= 200

Product catalogue | PCB connection systems | PCB plug-in connectors | Pitch 5.00 / 5.08 mm (0.197 / 0.200 inch) | Socket connectors, tension clamp connection, pitch 5.00/5.08 | BLZ 5.00-5.08/90/270 | BLZ 5.00/270B

Material data

Contact base material	Copper alloy
Contact surface	tinned

Connectable conductors

Clamping range, min.	0.13 mm ²
Clamping range, max.	3.31 mm ²
AWG, min.	26
AWG, max.	12
Solid, min. H05(07) V-U	0.5 mm ²
Solid, max. H05(07) V-U	2.5 mm ²
Flexible, min. H05(07) V-K	0.5 mm ²
Flexible, max. H05(07) V-K	2.5 mm ²
With wire end ferrule, acc. to DIN 46 228/1, min.	0.5 mm ²
With wire end ferrule, acc. to DIN 46 228/1, max.	2.5 mm ²
w. plastic collar ferrule, DIN 46228 pt 4, min.	0.5 mm ²
w. plastic collar ferrule, DIN 46228 pt 4, max.	2.5 mm ²
Gauge to EN 60999 a x b; ø	2.8 mm x 2.0 mm; 2.4 mm

DIN IEC rating data

Rated current, min. No. pins (Tu=20°C)	15 A
Rated current, max. No. pins (Tu=20°C)	12 A
Rated current, min. No. pins (Tu=40°C)	12 A
Rated current, max. No. pins (Tu=40°C)	10 A
Rated voltage for overvoltage class/pollution severity II/2	400 V
Rated voltage for overvoltage class/pollution severity III/2	320 V
Rated voltage for overvoltage class/pollution severity III/3	250 V
Rated impulse withstand voltage for overvoltage class/pollution severity II/2	4 kV
Rated impulse withstand voltage for overvoltage class/pollution severity III/2	4 kV
Rated impulse withstand voltage for overvoltage class/pollution severity III/3	4 kV
Short-time withstand current resistance	3 x 1s with 120 A

CSA rating data

Rated voltage (Use group D)	300 V
Rated current (Use group D)	10 A
AWG conductor (field wiring), min.	26
AWG conductor (field wiring), max.	12

UL 1059 rating data

Rated voltage (Use group D)	300 V
Rated current (Use group D)	10 A
AWG conductor, min.	26
AWG conductor, max.	12

Approvals

Approvals institutes



Classifications

ETIM 2.0	NK
ETIM 3.0	EC001284
eClass 4.1	27-26-07-01
eClass 5.0	27-26-07-01
eClass 5.1	27-26-07-04

Similar products

Order No.	Part designation	Version
1638040000	BLZ 5.00/2/270B SN OR	PCB plug-in connector, Female connectors, Clamping yoke connection, Clamping range, max.: 3.31 mm ² , Pitch: 5.00 mm, No. of poles: 2, 270°, Box
1638270000	BLZ 5.00/2/270B SN SW	PCB plug-in connector, Female connectors, Clamping yoke connection, Clamping range, max.: 3.31 mm ² , Pitch: 5.00 mm, No. of poles: 2, 270°, Box
1638050000	BLZ 5.00/3/270B SN OR	PCB plug-in connector, Female connectors, Clamping yoke connection, Clamping range, max.: 3.31 mm ² , Pitch: 5.00 mm, No. of poles: 3, 270°, Box
1638060000	BLZ 5.00/4/270B SN OR	PCB plug-in connector, Female connectors, Clamping yoke connection, Clamping range, max.: 3.31 mm ² , Pitch: 5.00 mm, No. of poles: 4, 270°, Box
1638290000	BLZ 5.00/4/270B SN SW	PCB plug-in connector, Female connectors, Clamping yoke connection, Clamping range, max.: 3.31 mm ² , Pitch: 5.00 mm, No. of poles: 4, 270°, Box
1638070000	BLZ 5.00/5/270B SN OR	PCB plug-in connector, Female connectors, Clamping yoke connection, Clamping range, max.: 3.31 mm ² , Pitch: 5.00 mm, No. of poles: 5, 270°, Box
1638300000	BLZ 5.00/5/270B SN SW	PCB plug-in connector, Female connectors, Clamping yoke connection, Clamping range, max.: 3.31 mm ² , Pitch: 5.00 mm, No. of poles: 5, 270°, Box
1638080000	BLZ 5.00/6/270B SN OR	PCB plug-in connector, Female connectors, Clamping yoke connection, Clamping range, max.: 3.31 mm ² , Pitch: 5.00 mm, No. of poles: 6, 270°, Box
1638310000	BLZ 5.00/6/270B SN SW	PCB plug-in connector, Female connectors, Clamping yoke connection, Clamping range, max.: 3.31 mm ² , Pitch: 5.00 mm, No. of poles: 6, 270°, Box
1638090000	BLZ 5.00/7/270B SN OR	PCB plug-in connector, Female connectors, Clamping yoke connection, Clamping range, max.: 3.31 mm ² , Pitch: 5.00 mm, No. of poles: 7, 270°, Box
1638320000	BLZ 5.00/7/270B SN SW	PCB plug-in connector, Female connectors, Clamping yoke connection, Clamping range, max.: 3.31 mm ² , Pitch: 5.00 mm, No. of poles: 7, 270°, Box

Product catalogue | PCB connection systems | PCB plug-in connectors | Pitch 5.00 / 5.08 mm (0.197 / 0.200 inch) | Socket connectors, tension clamp connection, pitch 5.00/5.08 | BLZ 5.00-5.08/90/270 | BLZ 5.00/270B

1638100000	BLZ 5.00/8/270B SN OR	PCB plug-in connector, Female connectors, Clamping yoke connection, Clamping range, max.: 3.31 mm ² , Pitch: 5.00 mm, No. of poles: 8, 270°, Box
1638330000	BLZ 5.00/8/270B SN SW	PCB plug-in connector, Female connectors, Clamping yoke connection, Clamping range, max.: 3.31 mm ² , Pitch: 5.00 mm, No. of poles: 8, 270°, Box
1638110000	BLZ 5.00/9/270B SN OR	PCB plug-in connector, Female connectors, Clamping yoke connection, Clamping range, max.: 3.31 mm ² , Pitch: 5.00 mm, No. of poles: 9, 270°, Box
1638340000	BLZ 5.00/9/270B SN SW	PCB plug-in connector, Female connectors, Clamping yoke connection, Clamping range, max.: 3.31 mm ² , Pitch: 5.00 mm, No. of poles: 9, 270°, Box
1638120000	BLZ 5.00/10/270B SN OR	PCB plug-in connector, Female connectors, Clamping yoke connection, Clamping range, max.: 3.31 mm ² , Pitch: 5.00 mm, No. of poles: 10, 270°, Box
1638350000	BLZ 5.00/10/270B SN SW	PCB plug-in connector, Female connectors, Clamping yoke connection, Clamping range, max.: 3.31 mm ² , Pitch: 5.00 mm, No. of poles: 10, 270°, Box
1638130000	BLZ 5.00/11/270B SN OR	PCB plug-in connector, Female connectors, Clamping yoke connection, Clamping range, max.: 3.31 mm ² , Pitch: 5.00 mm, No. of poles: 11, 270°, Box
1638360000	BLZ 5.00/11/270B SN SW	PCB plug-in connector, Female connectors, Clamping yoke connection, Clamping range, max.: 3.31 mm ² , Pitch: 5.00 mm, No. of poles: 11, 270°, Box
1638140000	BLZ 5.00/12/270B SN OR	PCB plug-in connector, Female connectors, Clamping yoke connection, Clamping range, max.: 3.31 mm ² , Pitch: 5.00 mm, No. of poles: 12, 270°, Box
1638150000	BLZ 5.00/13/270B SN OR	PCB plug-in connector, Female connectors, Clamping yoke connection, Clamping range, max.: 3.31 mm ² , Pitch: 5.00 mm, No. of poles: 13, 270°, Box
1638160000	BLZ 5.00/14/270B SN OR	PCB plug-in connector, Female connectors, Clamping yoke connection, Clamping range, max.: 3.31 mm ² , Pitch: 5.00 mm, No. of poles: 14, 270°, Box
1638170000	BLZ 5.00/15/270B SN OR	PCB plug-in connector, Female connectors, Clamping yoke connection, Clamping range, max.: 3.31 mm ² , Pitch: 5.00 mm, No. of poles: 15, 270°, Box
1638190000	BLZ 5.00/17/270B SN OR	PCB plug-in connector, Female connectors, Clamping yoke connection, Clamping range, max.: 3.31 mm ² , Pitch: 5.00 mm, No. of poles: 17, 270°, Box
1638200000	BLZ 5.00/18/270B SN OR	PCB plug-in connector, Female connectors, Clamping yoke connection, Clamping range, max.: 3.31 mm ² , Pitch: 5.00 mm, No. of poles: 18, 270°, Box
1638210000	BLZ 5.00/19/270B SN OR	PCB plug-in connector, Female connectors, Clamping yoke connection, Clamping range, max.: 3.31 mm ² , Pitch: 5.00 mm, No. of poles: 19, 270°, Box
1638220000	BLZ 5.00/20/270B SN OR	PCB plug-in connector, Female connectors, Clamping yoke connection, Clamping range, max.: 3.31 mm ² , Pitch: 5.00 mm, No. of poles: 20, 270°, Box
1638230000	BLZ 5.00/21/270B SN OR	PCB plug-in connector, Female connectors, Clamping yoke connection, Clamping range, max.: 3.31 mm ² , Pitch: 5.00 mm, No. of poles: 21, 270°, Box

Product catalogue | PCB connection systems | PCB plug-in connectors | Pitch 5.00 / 5.08 mm (0.197 / 0.200 inch) | Socket connectors, tension clamp connection, pitch 5.00/5.08 | BLZ 5.00-5.08/90/270 | BLZ 5.00/270B

1638240000	BLZ 5.00/22/270B SN OR	PCB plug-in connector, Female connectors, Clamping yoke connection, Clamping range, max.: 3.31 mm ² , Pitch: 5.00 mm, No. of poles: 22, 270°, Box
1638250000	BLZ 5.00/23/270B SN OR	PCB plug-in connector, Female connectors, Clamping yoke connection, Clamping range, max.: 3.31 mm ² , Pitch: 5.00 mm, No. of poles: 23, 270°, Box
1638260000	BLZ 5.00/24/270B SN OR	PCB plug-in connector, Female connectors, Clamping yoke connection, Clamping range, max.: 3.31 mm ² , Pitch: 5.00 mm, No. of poles: 24, 270°, Box