

Excellent Integrated System Limited

Stocking Distributor

Click to view price, real time Inventory, Delivery & Lifecycle Information:

[Weidmüller](#)
[1630660000](#)

For any questions, you can email us directly:

sales@integrated-circuit.com

Product catalogue | PCB connection systems | PCB plug-in connectors | Pitch 5.00 / 5.08 mm (0.197 / 0.200 inch) | Plug connectors, solder connection, pitch 5.00/5.08 | SL 5.00-5.08/135 | SL 5.00/135B

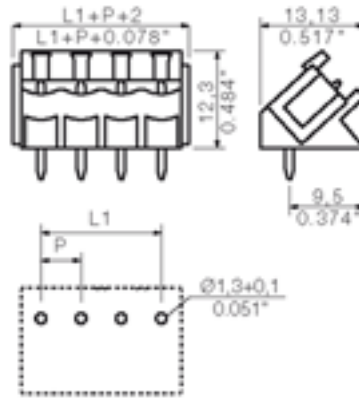

General ordering data

Order No.	1630660000
Part designation	SL 5.00/20/135B3.2SN OR
Version	PCB plug-in connector, Male connectors, Soldered connection, Pitch: 5.00 mm, No. of poles: 20, 135°, Box
EAN	4008190204082
Qty.	20 pc(s).

System parameters

Fitted to PCB	Soldered connection
Outgoing elbow	135°
Pitch	5 mm
Pitch in inch	0.197 inch
No. of poles	20
Solder pin length	3.2 mm
Can be coded	Yes
No. of rows	1
No. of solder pins per pole	1
Dia. of fitting hole	1.3 mm
Fitting hole tolerance	+ 0.1 mm
L1 in mm	95 mm
L1 in inch	3.74 inch
Insulation resistance	1 MΩ

Product catalogue | PCB connection systems | PCB plug-in connectors | Pitch 5.00 / 5.08 mm (0.197 / 0.200 inch) | Plug connectors, solder connection, pitch 5.00/5.08 | SL 5.00-5.08/135 | SL 5.00/135B

System parameters

Electric shock protection to DIN VDE 0470 Finger-safe plugged/ back-of-hand-safe unplugged

Material data

Insulating material	PBT
Colour	orange
colour chart	Similar to RAL 2000
Insulating material group	IIIa
Flammability class UL 94	V-0
CTI	>= 200
Contact base material	CuSn
Contact surface	tinned
Constant operating temp., min.	-25 °C
Constant operating temp., max.	100 °C
Storage temperature, min.	-25 °C
Storage temperature, max.	55 °C
Max. relative humidity during storage	80 %

DIN IEC rating data

Rated current, min. No. pins (Tu=20°C)	17 A
Rated current, max. No. pins (Tu=20°C)	13 A
Rated current, min. No. pins (Tu=40°C)	15 A
Rated current, max. No. pins (Tu=40°C)	11 A
Rated voltage for overvoltage class/pollution severity III/3	250 V
Rated impulse withstand voltage for overvoltage class/pollution severity III/3	4 kV
Rated voltage for overvoltage class/pollution severity III/2	320 V
Rated impulse withstand voltage for overvoltage class/pollution severity III/2	4 kV
Rated voltage for overvoltage class/pollution severity II/2	400 V
Rated impulse withstand voltage for overvoltage class/pollution severity II/2	4 kV
Short-time withstand current resistance	3 x 1s with 120 A

CSA rating data

Rated voltage (Use group D)	300 V
Rated current (Use group D)	10 A

UL 1059 rating data

Rated voltage (Use group D)	300 V
Rated current (Use group D)	10 A

Approvals

Approvals institutes



Classifications

ETIM 2.0	NK
ETIM 3.0	EC001284
eClass 4.1	27-26-07-01
eClass 5.0	27-26-07-01
eClass 5.1	27-26-07-04

Similar products

Order No.	Part designation	Version
1630480000	SL 5.00/2/135B3.2SN OR	PCB plug-in connector, Male connectors, Soldered connection, Pitch: 5.00 mm, No. of poles: 2, 135°, Box
1630490000	SL 5.00/3/135B3.2SN OR	PCB plug-in connector, Male connectors, Soldered connection, Pitch: 5.00 mm, No. of poles: 3, 135°, Box
1630500000	SL 5.00/4/135B3.2SN OR	PCB plug-in connector, Male connectors, Soldered connection, Pitch: 5.00 mm, No. of poles: 4, 135°, Box
1630510000	SL 5.00/5/135B3.2SN OR	PCB plug-in connector, Male connectors, Soldered connection, Pitch: 5.00 mm, No. of poles: 5, 135°, Box
1630520000	SL 5.00/6/135B3.2SN OR	PCB plug-in connector, Male connectors, Soldered connection, Pitch: 5.00 mm, No. of poles: 6, 135°, Box
1630530000	SL 5.00/7/135B3.2SN OR	PCB plug-in connector, Male connectors, Soldered connection, Pitch: 5.00 mm, No. of poles: 7, 135°, Box
1630540000	SL 5.00/8/135B3.2SN OR	PCB plug-in connector, Male connectors, Soldered connection, Pitch: 5.00 mm, No. of poles: 8, 135°, Box
1630550000	SL 5.00/9/135B3.2SN OR	PCB plug-in connector, Male connectors, Soldered connection, Pitch: 5.00 mm, No. of poles: 9, 135°, Box
1630560000	SL 5.00/10/135B3.2SN OR	PCB plug-in connector, Male connectors, Soldered connection, Pitch: 5.00 mm, No. of poles: 10, 135°, Box
1630570000	SL 5.00/11/135B3.2SN OR	PCB plug-in connector, Male connectors, Soldered connection, Pitch: 5.00 mm, No. of poles: 11, 135°, Box
1630580000	SL 5.00/12/135B3.2SN OR	PCB plug-in connector, Male connectors, Soldered connection, Pitch: 5.00 mm, No. of poles: 12, 135°, Box

Product catalogue | PCB connection systems | PCB plug-in connectors | Pitch 5.00 / 5.08 mm (0.197 / 0.200 inch) | Plug connectors, solder connection, pitch 5.00/5.08 | SL 5.00-5.08/135 | SL 5.00/135B

1630590000	SL 5.00/13/135B3.2SN OR	PCB plug-in connector, Male connectors, Soldered connection, Pitch: 5.00 mm, No. of poles: 13, 135°, Box
1630600000	SL 5.00/14/135B3.2SN OR	PCB plug-in connector, Male connectors, Soldered connection, Pitch: 5.00 mm, No. of poles: 14, 135°, Box
1630610000	SL 5.00/15/135B3.2SN OR	PCB plug-in connector, Male connectors, Soldered connection, Pitch: 5.00 mm, No. of poles: 15, 135°, Box
1630620000	SL 5.00/16/135B3.2SN OR	PCB plug-in connector, Male connectors, Soldered connection, Pitch: 5.00 mm, No. of poles: 16, 135°, Box
1630630000	SL 5.00/17/135B3.2SN OR	PCB plug-in connector, Male connectors, Soldered connection, Pitch: 5.00 mm, No. of poles: 17, 135°, Box
1630640000	SL 5.00/18/135B3.2SN OR	PCB plug-in connector, Male connectors, Soldered connection, Pitch: 5.00 mm, No. of poles: 18, 135°, Box
1630650000	SL 5.00/19/135B3.2SN OR	PCB plug-in connector, Male connectors, Soldered connection, Pitch: 5.00 mm, No. of poles: 19, 135°, Box
1630670000	SL 5.00/21/135B3.2SN OR	PCB plug-in connector, Male connectors, Soldered connection, Pitch: 5.00 mm, No. of poles: 21, 135°, Box
1630680000	SL 5.00/22/135B3.2SN OR	PCB plug-in connector, Male connectors, Soldered connection, Pitch: 5.00 mm, No. of poles: 22, 135°, Box
1630690000	SL 5.00/23/135B3.2SN OR	PCB plug-in connector, Male connectors, Soldered connection, Pitch: 5.00 mm, No. of poles: 23, 135°, Box
1630700000	SL 5.00/24/135B3.2SN OR	PCB plug-in connector, Male connectors, Soldered connection, Pitch: 5.00 mm, No. of poles: 24, 135°, Box