

Excellent Integrated System Limited

Stocking Distributor

Click to view price, real time Inventory, Delivery & Lifecycle Information:

[Weidmüller](#)
[1628550000](#)

For any questions, you can email us directly:

sales@integrated-circuit.com

Product catalogue | PCB connection systems | PCB plug-in connectors | Pitch 7.50 / 7.62 mm (0.295 / 0.300 inch) | Plug connectors, solder connection, pitch 7.50/7.62 | SL 7.50-7.62/90 | SL 7.50/90B

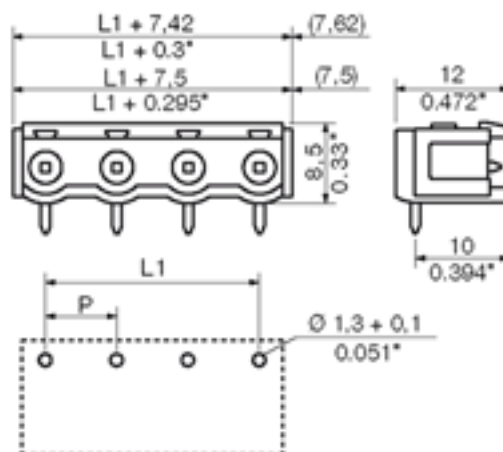

General ordering data

Order No.	1628550000
Part designation	SL 7.50/10/90B3.2SN OR
Version	PCB plug-in connector, Male connectors, Soldered connection, Pitch: 7.50 mm, No. of poles: 10, 90°, Box
EAN	4008190201357
Qty.	50 pc(s).

System parameters

Fitted to PCB	Soldered connection
Outgoing elbow	90°
Pitch	7.5 mm
Pitch in inch	0.295 inch
No. of poles	10
Solder pin length	3.2 mm
Can be coded	Yes
No. of rows	1
No. of solder pins per pole	1
Dia. of fitting hole	1.3 mm
Fitting hole tolerance	+ 0.1 mm
L1 in mm	67.5 mm
L1 in inch	2.657 inch
Insulation resistance	1 MΩ

Product catalogue | PCB connection systems | PCB plug-in connectors | Pitch 7.50 / 7.62 mm (0.295 / 0.300 inch) | Plug connectors, solder connection, pitch 7.50/7.62 | SL 7.50-7.62/90 | SL 7.50/90B

System parameters

Electric shock protection to DIN VDE 0470 Safe from finger touch, plugged

Material data

Insulating material	PBT
Colour	orange
colour chart	Similar to RAL 2000
Insulating material group	IIIa
Flammability class UL 94	V-0
CTI	>= 200
Contact base material	CuSn
Contact surface	tinned
Constant operating temp., min.	-25 °C
Constant operating temp., max.	100 °C
Storage temperature, min.	-25 °C
Storage temperature, max.	55 °C
Max. relative humidity during storage	80 %

DIN IEC rating data

Rated current, min. No. pins (Tu=20°C)	18.5 A
Rated current, max. No. pins (Tu=20°C)	17 A
Rated current, min. No. pins (Tu=40°C)	16 A
Rated current, max. No. pins (Tu=40°C)	14.5 A
Rated voltage for overvoltage class/pollution severity III/3	500 V
Rated impulse withstand voltage for overvoltage class/pollution severity III/3	6 kV
Rated voltage for overvoltage class/pollution severity III/2	630 V
Rated impulse withstand voltage for overvoltage class/pollution severity III/2	6 kV
Rated voltage for overvoltage class/pollution severity II/2	800 V
Rated impulse withstand voltage for overvoltage class/pollution severity II/2	6 kV
Short-time withstand current resistance	3 x 1s with 120 A

CSA rating data

Rated voltage (Use group D)	300 V
Rated current (Use group D)	10 A

UL 1059 rating data

Rated voltage (Use group D)	300 V
Rated current (Use group D)	10 A

Approvals

Approvals institutes



Downloads

CAD Library (P-CAD Format - Standard) SL.LIB

Classifications

ETIM 2.0	NK
ETIM 3.0	EC001284
eClass 4.1	27-26-07-01
eClass 5.0	27-26-07-01
eClass 5.1	27-26-07-04

Similar products

Order No.	Part designation	Version
1628470000	SL 7.50/2/90B3.2SN OR	PCB plug-in connector, Male connectors, Soldered connection, Pitch: 7.50 mm, No. of poles: 2, 90°, Box
1628480000	SL 7.50/3/90B3.2SN OR	PCB plug-in connector, Male connectors, Soldered connection, Pitch: 7.50 mm, No. of poles: 3, 90°, Box
1628490000	SL 7.50/4/90B3.2SN OR	PCB plug-in connector, Male connectors, Soldered connection, Pitch: 7.50 mm, No. of poles: 4, 90°, Box
1628500000	SL 7.50/5/90B3.2SN OR	PCB plug-in connector, Male connectors, Soldered connection, Pitch: 7.50 mm, No. of poles: 5, 90°, Box
1628510000	SL 7.50/6/90B3.2SN OR	PCB plug-in connector, Male connectors, Soldered connection, Pitch: 7.50 mm, No. of poles: 6, 90°, Box
1628520000	SL 7.50/7/90B3.2SN OR	PCB plug-in connector, Male connectors, Soldered connection, Pitch: 7.50 mm, No. of poles: 7, 90°, Box
1628530000	SL 7.50/8/90B3.2SN OR	PCB plug-in connector, Male connectors, Soldered connection, Pitch: 7.50 mm, No. of poles: 8, 90°, Box
1628540000	SL 7.50/9/90B3.2SN OR	PCB plug-in connector, Male connectors, Soldered connection, Pitch: 7.50 mm, No. of poles: 9, 90°, Box
1628560000	SL 7.50/11/90B3.2SN OR	PCB plug-in connector, Male connectors, Soldered connection, Pitch: 7.50 mm, No. of poles: 11, 90°, Box
1628570000	SL 7.50/12/90B3.2SN OR	PCB plug-in connector, Male connectors, Soldered connection, Pitch: 7.50 mm, No. of poles: 12, 90°, Box