

## Excellent Integrated System Limited

Stocking Distributor

Click to view price, real time Inventory, Delivery & Lifecycle Information:

[Weidmüller](#)  
[1627240000](#)

For any questions, you can email us directly:

[sales@integrated-circuit.com](mailto:sales@integrated-circuit.com)

Product catalogue | PCB connection systems | PCB plug-in connectors | Pitch 5.00 / 5.08 mm (0.197 / 0.200 inch) | Plug connectors, tension clamp connection, pitch 5.00/5.08 | SLS 5.08 | SLS 5.08/180B

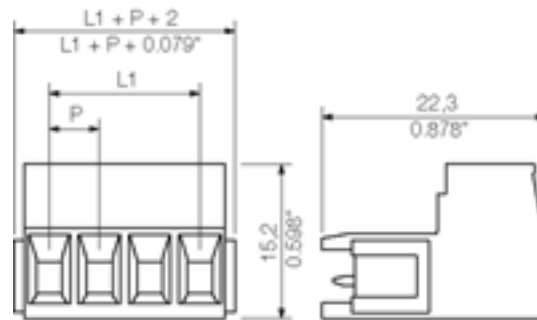
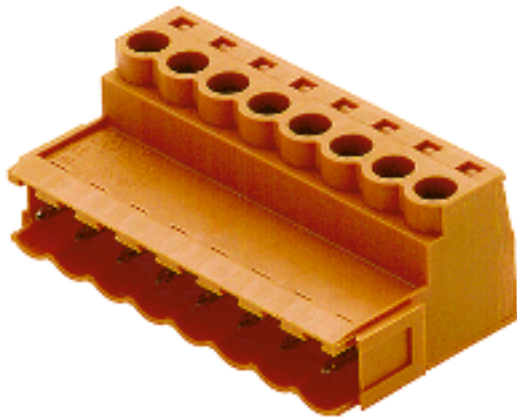
**General ordering data**

Order No.	1627240000
Part designation	SLS 5.08/2B SN OR
Version	PCB plug-in connector, Male connectors, Clamping yoke connection, Clamping range, max.: 3.31 mm <sup>2</sup> , Pitch: 5.08 mm, No. of poles: 2, 180°, Box
EAN	4008190199753
Qty.	100 pc(s).

**System parameters**

Conductor connection system	Clamping yoke connection
Outgoing direction of conductor	180°
Pitch	5.08 mm
Pitch in inch	0.2 inch
No. of poles	2
No. of rows	1
Tightening torque, min.	0.4 Nm
Tightening torque, max.	0.5 Nm
Clamping screw	M 2.5
Stripping length	7 mm
L1 in mm	5.08 mm
L1 in inch	0.2 inch

Product catalogue | PCB connection systems | PCB plug-in connectors | Pitch 5.00 / 5.08 mm (0.197 / 0.200 inch) | Plug connectors, tension clamp connection, pitch 5.00/5.08 | SLS 5.08 | SLS 5.08/180B

#### System parameters

Electric shock protection to DIN VDE 0470      Finger-safe plugged/ back-of-hand-safe unplugged

#### Material data

Insulating material      PBT  
 Colour      orange  
 colour chart      Similar to RAL 2000  
 Insulating material group      IIIa  
 Flammability class UL 94      V-0  
 CTI      >= 200  
 Contact base material      CuSn  
 Contact surface      tinned

#### Connectable conductors

Clamping range, min.      0.13 mm<sup>2</sup>  
 Clamping range, max.      3.31 mm<sup>2</sup>  
 AWG, min.      26  
 AWG, max.      12  
 Solid, min. H05(07) V-U      0.2 mm<sup>2</sup>  
 Solid, max. H05(07) V-U      2.5 mm<sup>2</sup>  
 Flexible, min. H05(07) V-K      0.2 mm<sup>2</sup>  
 Flexible, max. H05(07) V-K      2.5 mm<sup>2</sup>  
 With wire end ferrule, acc. to DIN 46 228/1, min.      0.2 mm<sup>2</sup>  
 With wire end ferrule, acc. to DIN 46 228/1, max.      2.5 mm<sup>2</sup>  
 w. plastic collar ferrule, DIN 46228 pt 4, min.      0.2 mm<sup>2</sup>  
 w. plastic collar ferrule, DIN 46228 pt 4, max.      2.5 mm<sup>2</sup>  
 Gauge to EN 60999 a x b; ø      2.8 mm x 2.0 mm; 2.4 mm

#### DIN IEC rating data

Rated current, min. No. pins (Tu=20°C)      21.5 A  
 Rated current, max. No. pins (Tu=20°C)      16 A  
 Rated current, min. No. pins (Tu=40°C)      18 A  
 Rated current, max. No. pins (Tu=40°C)      14 A  
 Rated voltage for overvoltage class/pollution severity II/2      400 V  
 Rated voltage for overvoltage class/pollution severity III/2      320 V  
 Rated voltage for overvoltage class/pollution severity III/3      250 V  
 Rated impulse withstand voltage for overvoltage class/pollution severity II/2      4 kV  
 Rated impulse withstand voltage for overvoltage class/pollution severity III/2      4 kV  
 Rated impulse withstand voltage for overvoltage class/pollution severity III/3      4 kV  
 Short-time withstand current resistance      3 x 1s with 120 A

#### CSA rating data

Rated voltage (Use group D)      300 V  
 Rated current (Use group D)      10 A  
 AWG conductor (field wiring), min.      26

Product catalogue | PCB connection systems | PCB plug-in connectors | Pitch 5.00 / 5.08 mm (0.197 / 0.200 inch) | Plug connectors, tension clamp connection, pitch 5.00/5.08 | SLS 5.08 | SLS 5.08/180B

#### CSA rating data

AWG conductor (field wiring), max. 12

#### UL 1059 rating data

Rated voltage (Use group D) 300 V

Rated current (Use group D) 10 A

AWG conductor, min. 26

AWG conductor, max. 12

#### Approvals

Approvals institutes



#### Classifications

ETIM 2.0	NK
ETIM 3.0	EC001284
eClass 4.1	27-26-07-01
eClass 5.0	27-26-07-01
eClass 5.1	27-26-07-04

#### Similar products

Order No.	Part designation	Version
1627250000	SLS 5.08/3B SN OR	PCB plug-in connector, Male connectors, Clamping yoke connection, Clamping range, max.: 3.31 mm <sup>2</sup> , Pitch: 5.08 mm, No. of poles: 3, 180°, Box
1627260000	SLS 5.08/4B SN OR	PCB plug-in connector, Male connectors, Clamping yoke connection, Clamping range, max.: 3.31 mm <sup>2</sup> , Pitch: 5.08 mm, No. of poles: 4, 180°, Box
1627270000	SLS 5.08/5B SN OR	PCB plug-in connector, Male connectors, Clamping yoke connection, Clamping range, max.: 3.31 mm <sup>2</sup> , Pitch: 5.08 mm, No. of poles: 5, 180°, Box
1627280000	SLS 5.08/6B SN OR	PCB plug-in connector, Male connectors, Clamping yoke connection, Clamping range, max.: 3.31 mm <sup>2</sup> , Pitch: 5.08 mm, No. of poles: 6, 180°, Box

Product catalogue | PCB connection systems | PCB plug-in connectors | Pitch 5.00 / 5.08 mm (0.197 / 0.200 inch) | Plug connectors, tension clamp connection, pitch 5.00/5.08 | SLS 5.08 | SLS 5.08/180B

1627290000	SLS 5.08/7B SN OR	PCB plug-in connector, Male connectors, Clamping yoke connection, Clamping range, max.: 3.31 mm <sup>2</sup> , Pitch: 5.08 mm, No. of poles: 7, 180°, Box
1627300000	SLS 5.08/8B SN OR	PCB plug-in connector, Male connectors, Clamping yoke connection, Clamping range, max.: 3.31 mm <sup>2</sup> , Pitch: 5.08 mm, No. of poles: 8, 180°, Box
1627310000	SLS 5.08/9B SN OR	PCB plug-in connector, Male connectors, Clamping yoke connection, Clamping range, max.: 3.31 mm <sup>2</sup> , Pitch: 5.08 mm, No. of poles: 9, 180°, Box
1627320000	SLS 5.08/10B SN OR	PCB plug-in connector, Male connectors, Clamping yoke connection, Clamping range, max.: 3.31 mm <sup>2</sup> , Pitch: 5.08 mm, No. of poles: 10, 180°, Box
1627330000	SLS 5.08/11B SN OR	PCB plug-in connector, Male connectors, Clamping yoke connection, Clamping range, max.: 3.31 mm <sup>2</sup> , Pitch: 5.08 mm, No. of poles: 11, 180°, Box
1627340000	SLS 5.08/12B SN OR	PCB plug-in connector, Male connectors, Clamping yoke connection, Clamping range, max.: 3.31 mm <sup>2</sup> , Pitch: 5.08 mm, No. of poles: 12, 180°, Box
1627350000	SLS 5.08/13B SN OR	PCB plug-in connector, Male connectors, Clamping yoke connection, Clamping range, max.: 3.31 mm <sup>2</sup> , Pitch: 5.08 mm, No. of poles: 13, 180°, Box
1627360000	SLS 5.08/14B SN OR	PCB plug-in connector, Male connectors, Clamping yoke connection, Clamping range, max.: 3.31 mm <sup>2</sup> , Pitch: 5.08 mm, No. of poles: 14, 180°, Box
1627370000	SLS 5.08/15B SN OR	PCB plug-in connector, Male connectors, Clamping yoke connection, Clamping range, max.: 3.31 mm <sup>2</sup> , Pitch: 5.08 mm, No. of poles: 15, 180°, Box
1627380000	SLS 5.08/16B SN OR	PCB plug-in connector, Male connectors, Clamping yoke connection, Clamping range, max.: 3.31 mm <sup>2</sup> , Pitch: 5.08 mm, No. of poles: 16, 180°, Box
1645150000	SLS 5.08/17B SN OR	PCB plug-in connector, Male connectors, Clamping yoke connection, Clamping range, max.: 3.31 mm <sup>2</sup> , Pitch: 5.08 mm, No. of poles: 17, 180°, Box
1645160000	SLS 5.08/18B SN OR	PCB plug-in connector, Male connectors, Clamping yoke connection, Clamping range, max.: 3.31 mm <sup>2</sup> , Pitch: 5.08 mm, No. of poles: 18, 180°, Box
1645170000	SLS 5.08/19B SN OR	PCB plug-in connector, Male connectors, Clamping yoke connection, Clamping range, max.: 3.31 mm <sup>2</sup> , Pitch: 5.08 mm, No. of poles: 19, 180°, Box
1645180000	SLS 5.08/20B SN OR	PCB plug-in connector, Male connectors, Clamping yoke connection, Clamping range, max.: 3.31 mm <sup>2</sup> , Pitch: 5.08 mm, No. of poles: 20, 180°, Box
1645190000	SLS 5.08/21B SN OR	PCB plug-in connector, Male connectors, Clamping yoke connection, Clamping range, max.: 3.31 mm <sup>2</sup> , Pitch: 5.08 mm, No. of poles: 21, 180°, Box
1645200000	SLS 5.08/22B SN OR	PCB plug-in connector, Male connectors, Clamping yoke connection, Clamping range, max.: 3.31 mm <sup>2</sup> , Pitch: 5.08 mm, No. of poles: 22, 180°, Box
1645210000	SLS 5.08/23B SN OR	PCB plug-in connector, Male connectors, Clamping yoke connection, Clamping range, max.: 3.31 mm <sup>2</sup> , Pitch: 5.08 mm, No. of poles: 23, 180°, Box

---

Product catalogue | PCB connection systems | PCB plug-in connectors | Pitch 5.00 / 5.08 mm (0.197 / 0.200 inch) | Plug connectors, tension clamp connection, pitch 5.00/5.08 | SLS 5.08 | SLS 5.08/180B

---

1645220000 SLS 5.08/24B SN OR

PCB plug-in connector, Male connectors, Clamping yoke connection, Clamping range, max.: 3.31 mm<sup>2</sup>, Pitch: 5.08 mm, No. of poles: 24, 180°, Box