

Excellent Integrated System Limited

Stocking Distributor

Click to view price, real time Inventory, Delivery & Lifecycle Information:

[Weidmüller](#)
[1774882001](#)

For any questions, you can email us directly:
sales@integrated-circuit.com

Product catalogue | PCB connection systems | PCB plug-in connectors | Pitch 5.00 / 5.08 mm (0.197 / 0.200 inch) | Plug connectors, THR solder connection, pitch 5.00/5.08 | SL-SMT 5.00-5.08/90 | SL-SMT 5.08/90 Box

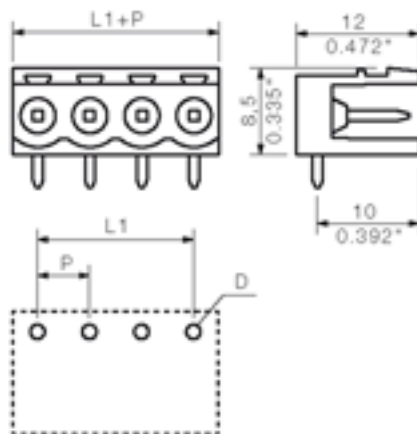

General ordering data

Order No.	1774882001
Part designation	SL-SMT5.08/14/90 1.5SN
Version	PCB plug-in connector, Male connectors, Reflow solder connection, Pitch: 5.08 mm, No. of poles: 14, 90°, Box
EAN	4032248155927
Qty.	50 pc(s).

System parameters

Fitted to PCB	Reflow solder connection
Outgoing elbow	90°
Pitch	5.08 mm
Pitch in inch	0.2 inch
No. of poles	14
Solder pin length	1.5 mm
Can be coded	Yes
No. of solder pins per pole	1
L1 in mm	66.04 mm
L1 in inch	2.6 inch

Material data

Insulating material	LCP GF
Colour	black

Product catalogue | PCB connection systems | PCB plug-in connectors | Pitch 5.00 / 5.08 mm (0.197 / 0.200 inch) | Plug connectors, THR solder connection, pitch 5.00/5.08 | SL-SMT 5.00-5.08/90 | SL-SMT 5.08/90 Box

Material data

colour chart	Similar to RAL 9011
Insulating material group	IIIa
Flammability class UL 94	V-0
Contact base material	CuSn
Contact surface	tinned
Constant operating temp., min.	-25 °C
Constant operating temp., max.	100
Storage temperature, min.	-25 °C
Storage temperature, max.	55 °C
Max. relative humidity during storage	80 %

DIN IEC rating data

Rated current, min. No. pins (Tu=20°C)	19 A
Rated current, max. No. pins (Tu=20°C)	15 A
Rated current, min. No. pins (Tu=40°C)	16 A
Rated current, max. No. pins (Tu=40°C)	13 A
Rated voltage for overvoltage class/pollution severity III/3	250 V
Rated impulse withstand voltage for overvoltage class/pollution severity III/3	4 kV
Rated voltage for overvoltage class/pollution severity III/2	320 V
Rated impulse withstand voltage for overvoltage class/pollution severity III/2	4 kV
Rated voltage for overvoltage class/pollution severity II/2	400 V
Rated impulse withstand voltage for overvoltage class/pollution severity II/2	4 kV

CSA rating data

Rated voltage (Use group D)	300 V
Rated current (Use group D)	10 A

UL 1059 rating data

Rated voltage (Use group D)	300 V
Rated current (Use group D)	10 A

Product catalogue | PCB connection systems | PCB plug-in connectors | Pitch 5.00 / 5.08 mm (0.197 / 0.200 inch) | Plug connectors, THR solder connection, pitch 5.00/5.08 | SL-SMT 5.00-5.08/90 | SL-SMT 5.08/90 Box

Approvals

Approvals institutes



Classifications

ETIM 2.0	NK
ETIM 3.0	EC001284
eClass 4.1	27-26-07-01
eClass 5.0	27-26-07-01
eClass 5.1	27-26-07-04

Similar products

Order No.	Part designation	Version
1774762001	SL-SMT5.08/2/90 1.5SN	PCB plug-in connector, Male connectors, Reflow solder connection, Pitch: 5.08 mm, No. of poles: 2, 90°, Box
1779950000	SL-SMT5.08/2/90 3.2SN	PCB plug-in connector, Male connectors, Reflow solder connection, Pitch: 5.08 mm, No. of poles: 2, 90°, Box
1774772001	SL-SMT5.08/3/90 1.5SN	PCB plug-in connector, Male connectors, Reflow solder connection, Pitch: 5.08 mm, No. of poles: 3, 90°, Box
1779960000	SL-SMT5.08/3/90 3.2SN	PCB plug-in connector, Male connectors, Reflow solder connection, Pitch: 5.08 mm, No. of poles: 3, 90°, Box
1774782001	SL-SMT5.08/4/90 1.5SN	PCB plug-in connector, Male connectors, Reflow solder connection, Pitch: 5.08 mm, No. of poles: 4, 90°, Box
1779970000	SL-SMT5.08/4/90 3.2SN	PCB plug-in connector, Male connectors, Reflow solder connection, Pitch: 5.08 mm, No. of poles: 4, 90°, Box
1774792001	SL-SMT5.08/5/90 1.5SN	PCB plug-in connector, Male connectors, Reflow solder connection, Pitch: 5.08 mm, No. of poles: 5, 90°, Box
1779980000	SL-SMT5.08/5/90 3.2SN	PCB plug-in connector, Male connectors, Reflow solder connection, Pitch: 5.08 mm, No. of poles: 5, 90°, Box
1774802001	SL-SMT5.08/6/90 1.5SN	PCB plug-in connector, Male connectors, Reflow solder connection, Pitch: 5.08 mm, No. of poles: 6, 90°, Box
1779990000	SL-SMT5.08/6/90 3.2SN	PCB plug-in connector, Male connectors, Reflow solder connection, Pitch: 5.08 mm, No. of poles: 6, 90°, Box
1774812001	SL-SMT5.08/7/90 1.5SN	PCB plug-in connector, Male connectors, Reflow solder connection, Pitch: 5.08 mm, No. of poles: 7, 90°, Box
1780000000	SL-SMT5.08/7/90 3.2SN	PCB plug-in connector, Male connectors, Reflow solder connection, Pitch: 5.08 mm, No. of poles: 7, 90°, Box

Product catalogue | PCB connection systems | PCB plug-in connectors | Pitch 5.00 / 5.08 mm (0.197 / 0.200 inch) | Plug connectors, THR solder connection, pitch 5.00/5.08 | SL-SMT 5.00-5.08/90 | SL-SMT 5.08/90 Box

1774822001	SL-SMT5.08/8/90 1.5SN	PCB plug-in connector, Male connectors, Reflow solder connection, Pitch: 5.08 mm, No. of poles: 8, 90°, Box
1780010000	SL-SMT5.08/8/90 3.2SN	PCB plug-in connector, Male connectors, Reflow solder connection, Pitch: 5.08 mm, No. of poles: 8, 90°, Box
1774832001	SL-SMT5.08/9/90 1.5SN	PCB plug-in connector, Male connectors, Reflow solder connection, Pitch: 5.08 mm, No. of poles: 9, 90°, Box
1780020000	SL-SMT5.08/9/90 3.2SN	PCB plug-in connector, Male connectors, Reflow solder connection, Pitch: 5.08 mm, No. of poles: 9, 90°, Box
1774842001	SL-SMT5.08/10/90 1.5SN	PCB plug-in connector, Male connectors, Reflow solder connection, Pitch: 5.08 mm, No. of poles: 10, 90°, Box
1780030000	SL-SMT5.08/10/90 3.2SN	PCB plug-in connector, Male connectors, Reflow solder connection, Pitch: 5.08 mm, No. of poles: 10, 90°, Box
1774852001	SL-SMT5.08/11/90 1.5SN	PCB plug-in connector, Male connectors, Reflow solder connection, Pitch: 5.08 mm, No. of poles: 11, 90°, Box
1780040000	SL-SMT5.08/11/90 3.2SN	PCB plug-in connector, Male connectors, Reflow solder connection, Pitch: 5.08 mm, No. of poles: 11, 90°, Box
1774862001	SL-SMT5.08/12/90 1.5SN	PCB plug-in connector, Male connectors, Reflow solder connection, Pitch: 5.08 mm, No. of poles: 12, 90°, Box
1780050000	SL-SMT5.08/12/90 3.2SN	PCB plug-in connector, Male connectors, Reflow solder connection, Pitch: 5.08 mm, No. of poles: 12, 90°, Box
1774872001	SL-SMT5.08/13/90 1.5SN	PCB plug-in connector, Male connectors, Reflow solder connection, Pitch: 5.08 mm, No. of poles: 13, 90°, Box
1780060000	SL-SMT5.08/13/90 3.2SN	PCB plug-in connector, Male connectors, Reflow solder connection, Pitch: 5.08 mm, No. of poles: 13, 90°, Box
1780070000	SL-SMT5.08/14/90 3.2SN	PCB plug-in connector, Male connectors, Reflow solder connection, Pitch: 5.08 mm, No. of poles: 14, 90°, Box
1774892001	SL-SMT5.08/15/90 1.5SN	PCB plug-in connector, Male connectors, Reflow solder connection, Pitch: 5.08 mm, No. of poles: 15, 90°, Box
1780080000	SL-SMT5.08/15/90 3.2SN	PCB plug-in connector, Male connectors, Reflow solder connection, Pitch: 5.08 mm, No. of poles: 15, 90°, Box
1774902001	SL-SMT5.08/16/90 1.5SN	PCB plug-in connector, Male connectors, Reflow solder connection, Pitch: 5.08 mm, No. of poles: 16, 90°, Box
1780090000	SL-SMT5.08/16/90 3.2SN	PCB plug-in connector, Male connectors, Reflow solder connection, Pitch: 5.08 mm, No. of poles: 16, 90°, Box
1774912001	SL-SMT5.08/17/90 1.5SN	PCB plug-in connector, Male connectors, Reflow solder connection, Pitch: 5.08 mm, No. of poles: 17, 90°, Box
1780100000	SL-SMT5.08/17/90 3.2SN	PCB plug-in connector, Male connectors, Reflow solder connection, Pitch: 5.08 mm, No. of poles: 17, 90°, Box
1774922001	SL-SMT5.08/18/90 1.5SN	PCB plug-in connector, Male connectors, Reflow solder connection, Pitch: 5.08 mm, No. of poles: 18, 90°, Box
1780110000	SL-SMT5.08/18/90 3.2SN	PCB plug-in connector, Male connectors, Reflow solder connection, Pitch: 5.08 mm, No. of poles: 18, 90°, Box
1774932001	SL-SMT5.08/19/90 1.5SN	PCB plug-in connector, Male connectors, Reflow solder connection, Pitch: 5.08 mm, No. of poles: 19, 90°, Box
1780120000	SL-SMT5.08/19/90 3.2SN	PCB plug-in connector, Male connectors, Reflow solder connection, Pitch: 5.08 mm, No. of poles: 19, 90°, Box
1774942001	SL-SMT5.08/20/90 1.5SN	PCB plug-in connector, Male connectors, Reflow solder connection, Pitch: 5.08 mm, No. of poles: 20, 90°, Box
1780130000	SL-SMT5.08/20/90 3.2SN	PCB plug-in connector, Male connectors, Reflow solder connection, Pitch: 5.08 mm, No. of poles: 20, 90°, Box
1774952001	SL-SMT5.08/21/90 1.5SN	PCB plug-in connector, Male connectors, Reflow solder connection, Pitch: 5.08 mm, No. of poles: 21, 90°, Box

Product catalogue | PCB connection systems | PCB plug-in connectors | Pitch 5.00 / 5.08 mm (0.197 / 0.200 inch) | Plug connectors, THR solder connection, pitch 5.00/5.08 | SL-SMT 5.00-5.08/90 | SL-SMT 5.08/90 Box

1780140000	SL-SMT5.08/21/90 3.2SN	PCB plug-in connector, Male connectors, Reflow solder connection, Pitch: 5.08 mm, No. of poles: 21, 90°, Box
1774962001	SL-SMT5.08/22/90 1.5SN	PCB plug-in connector, Male connectors, Reflow solder connection, Pitch: 5.08 mm, No. of poles: 22, 90°, Box
1780150000	SL-SMT5.08/22/90 3.2SN	PCB plug-in connector, Male connectors, Reflow solder connection, Pitch: 5.08 mm, No. of poles: 22, 90°, Box
1774972001	SL-SMT5.08/23/90 1.5SN	PCB plug-in connector, Male connectors, Reflow solder connection, Pitch: 5.08 mm, No. of poles: 23, 90°, Box
1780160000	SL-SMT5.08/23/90 3.2SN	PCB plug-in connector, Male connectors, Reflow solder connection, Pitch: 5.08 mm, No. of poles: 23, 90°, Box
1774982001	SL-SMT5.08/24/90 1.5SN	PCB plug-in connector, Male connectors, Reflow solder connection, Pitch: 5.08 mm, No. of poles: 24, 90°, Box
1780170000	SL-SMT5.08/24/90 3.2SN	PCB plug-in connector, Male connectors, Reflow solder connection, Pitch: 5.08 mm, No. of poles: 24, 90°, Box