

## Excellent Integrated System Limited

Stocking Distributor

Click to view price, real time Inventory, Delivery & Lifecycle Information:

[Desco](#)  
[38825](#)

For any questions, you can email us directly:

[sales@integrated-circuit.com](mailto:sales@integrated-circuit.com)

**Assembly Instructions for - 38825**

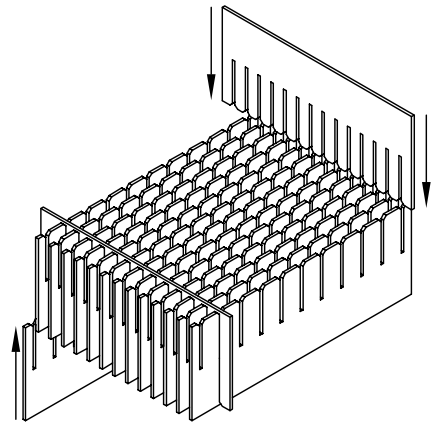
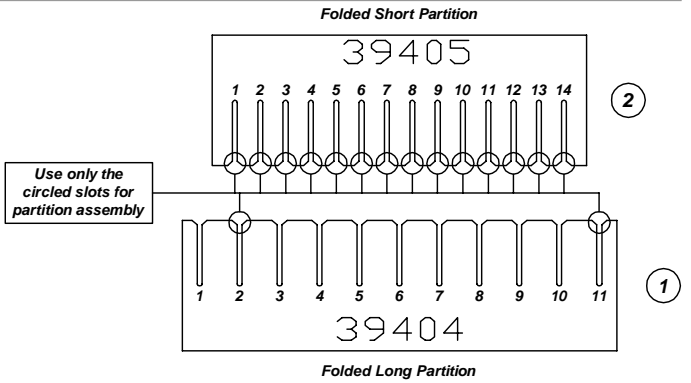
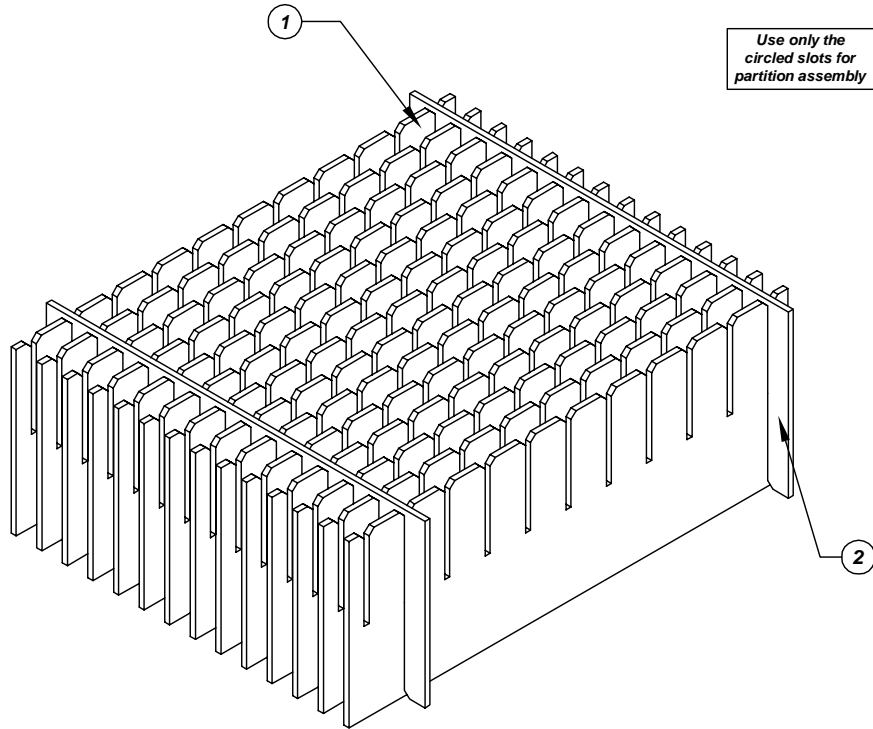

Made in America

F/N	Part #	Dimensions:	Description:	Qty:
1	39404	16-3/16" x 21-3/4"	Adjustable Long Partition	14
2	39405	16-3/16" x 18-3/4"	Adjustable Short Partition	2

**38825 - 15 Cell Inplant Handler**  
**Cell Size - 8" x 17-3/4" x 1"**

Notes:  
 For use with the following storage container & lid:  
 37532 - Storage Container  
 37557 - Lid

PROTEKTIVE PAK  
 13520 MONTE VISTA AVENUE, CHINO, CA 91710  
 PHONE (909) 627-2578, FAX (909) 363-7331  
 ProtektivePak.com



DRAWING NUMBER  
**IPH-38825**

DATE  
 Dec.  
 2007