

Excellent Integrated System Limited

Stocking Distributor

Click to view price, real time Inventory, Delivery & Lifecycle Information:

[Desco](#)
[38826](#)

For any questions, you can email us directly:

sales@integrated-circuit.com

Assembly Instructions for - 38826

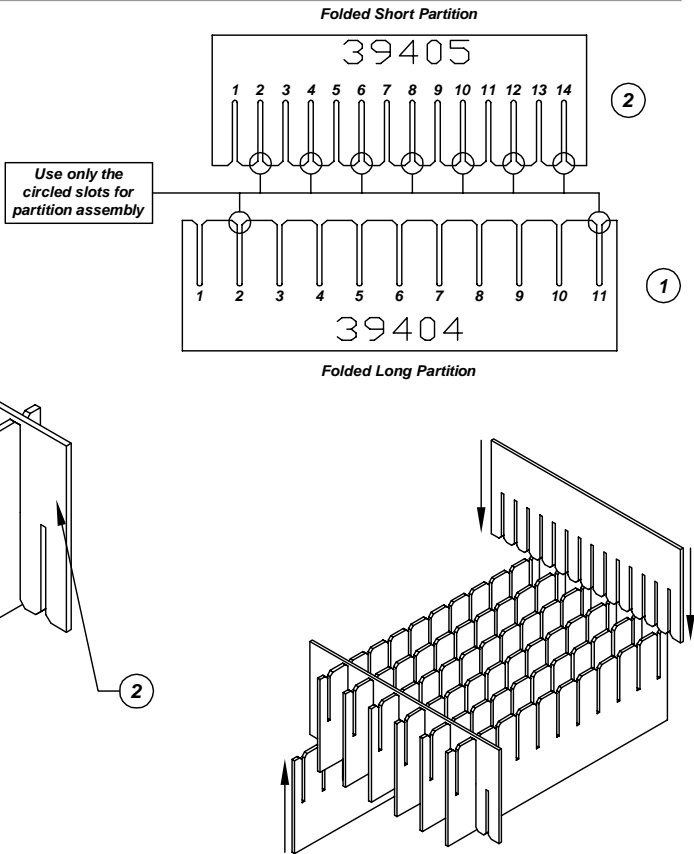
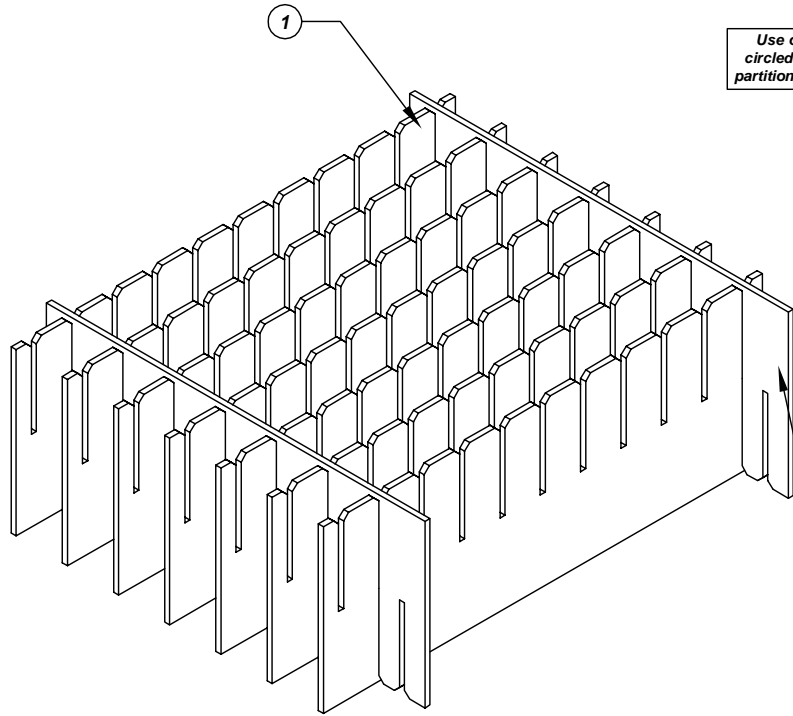

Made in America

F/N	Part #	Dimensions:	Description:	Qty:
1	39404	16-3/16" x 21-3/4"	Adjustable Long Partition	7
2	39405	16-3/16" x 18-3/4"	Adjustable Short Partition	2

38826 - 7 Cell Inplant Handler
Cell Size - 8" x 17-3/4" x 2-1/4"

Notes:
 For use with the following storage container & lid:
 37532 - Storage Container
 37557 - Lid

PROTEKTIVE PAK
 13520 MONTE VISTA AVENUE, CHINO, CA 91710
 PHONE (909) 627-2578, FAX (909) 363-7331
 ProtektivePak.com



DRAWING NUMBER
IPH-38826

DATE
 Dec.
 2007