

Excellent Integrated System Limited

Stocking Distributor

Click to view price, real time Inventory, Delivery & Lifecycle Information:

[Desco](#)
[38830](#)

For any questions, you can email us directly:

sales@integrated-circuit.com

Assembly Instructions for - 38830

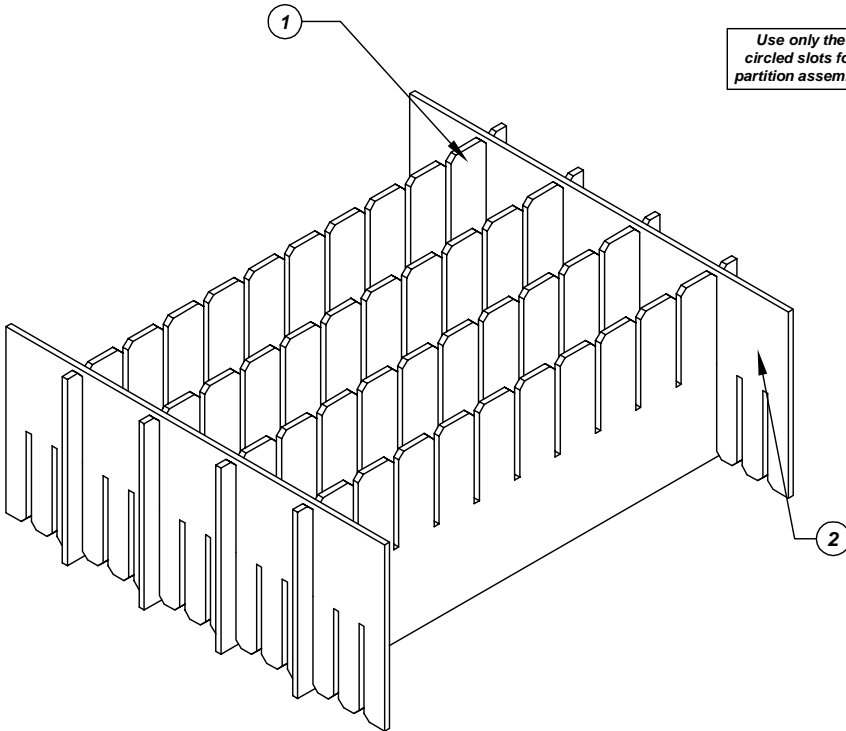

Use only the circled slots for partition assembly

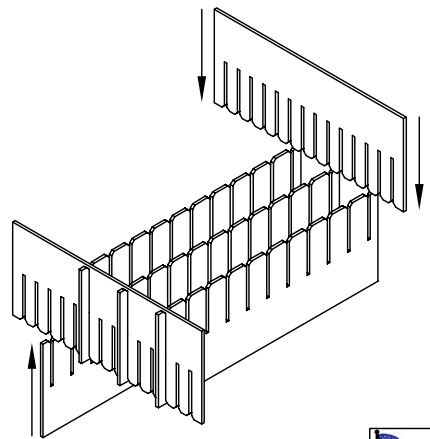
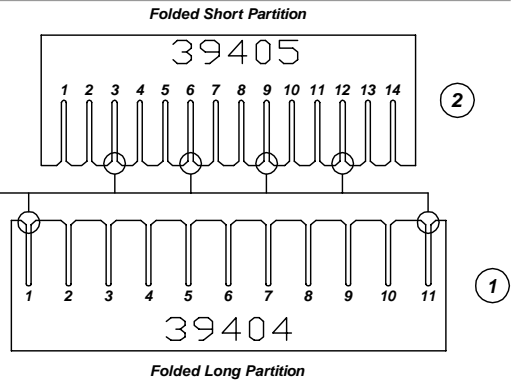

Made in America

F/N	Part #	Dimensions:	Description:	Qty:
1	39404	16-3/16" x 21-3/4"	Adjustable Long Partition	4
2	39405	16-3/16" x 18-3/4"	Adjustable Short Partition	2

38830 - 5 Cell Inplant Handler
Cell Size - 8" x 19-3/4" x 3-1/2"

Notes:
For use with the following storage container & lid:
37532 - Storage Container
37557 - Lid

PROTEKTIVE PAK
13520 MONTE VISTA AVENUE, CHINO, CA 91710
PHONE (909) 627-2578, FAX (909) 363-7331
ProtektivePak.com



DRAWING NUMBER
IPH-38830

DATE
Dec. 2007