

Excellent Integrated System Limited

Stocking Distributor

Click to view price, real time Inventory, Delivery & Lifecycle Information:

[Semtech](#)
[RCLAMP2654P.TCT](#)

For any questions, you can email us directly:

sales@integrated-circuit.com



RClamp2654P

Low Capacitance RClamp[®] Surge Protection for USB Interfaces

PROTECTION PRODUCTS - RailClamp[®]

Description

RailClamp[®] TVS arrays are low capacitance ESD protection devices designed to protect high speed data interfaces. The RClamp[®]2654P provides dedicated surge and ESD protection for uUSB ports. It is designed to replace multiple discrete components in portable applications. This device features low capacitance TVS diodes for protection of the USB data (DP, DM) and USB ID pins operating up to 4 volts. These diodes provide ESD protection to $\pm 15\text{kV}$ contact discharge per IEC 61000-4-2. Loading capacitance on these lines is $<0.80\text{pF}$. An integrated 26 volt TVS diode is used for protection of the USB voltage bus. The VBus TVS is designed with a high surge current capability of 80A ($t_p=8/20\mu\text{s}$) and low clamping voltage.

The RClamp2654P is in a 10-pin SLP2626P10 package. It measures 2.6 x 2.6mm with a nominal height of 0.60mm. This highly integrated device requires less board space than existing solutions.

The combination of small size, low capacitance, and high level of surge and ESD protection makes this device a flexible solution for protection of USB interfaces in mobile phones, laptops, and other portable electronics.

Features

- ◆ ESD and surge protection for USB Voltage Bus to **IEC 61000-4-2 (ESD) $\pm 30\text{kV}$ (air), $\pm 30\text{kV}$ (contact)**
IEC 61000-4-5 (Lightning) 80A (8/20 μs)
IEC 61000-4-4 (EFT) 40A (5/50ns)
- ◆ ESD protection for USB data lines to **IEC 61000-4-2 (ESD) $\pm 18\text{kV}$ (air), $\pm 15\text{kV}$ (contact)**
- ◆ Protects USB DP, DM, and ID Pin operating to 4V
- ◆ Protects USB VBus operating up to 26V
- ◆ Low capacitance (**$<0.80\text{pF}$**) on DP, DM, and ID Pins
- ◆ Low clamping voltage
- ◆ Extremely low dynamic resistance: 0.55 Ohms (Typ) on DP, DM, and ID Pins
- ◆ Solid-state silicon-avalanche technology

Mechanical Characteristics

- ◆ SLP2626P10 10L package
- ◆ Pb-Free, Halogen Free, RoHS/WEEE Compliant
- ◆ Nominal Dimensions: 2.6 x 2.6 x 0.60 mm
- ◆ Lead Finish: NiPdAu
- ◆ Molding compound flammability rating: UL 94V-0
- ◆ Marking : Marking Code + Date Code
- ◆ Packaging : Tape and Reel

Applications

- ◆ USB 2.0
- ◆ USB OTG
- ◆ uUSB

Circuit Diagram

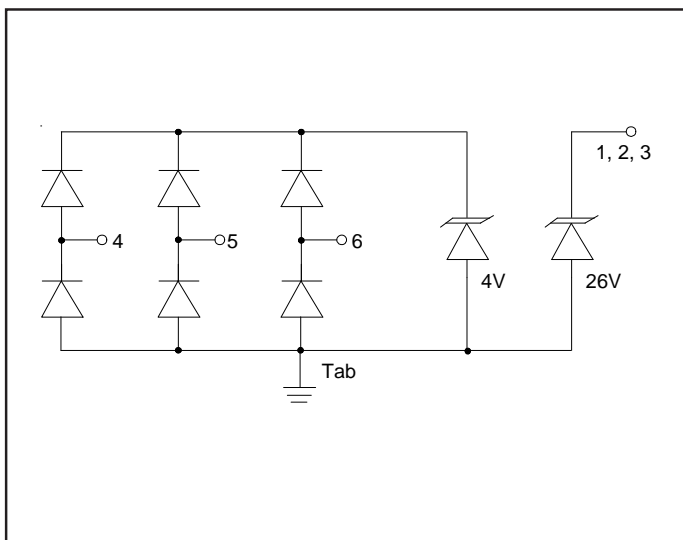

Pin Configuration (Top View)

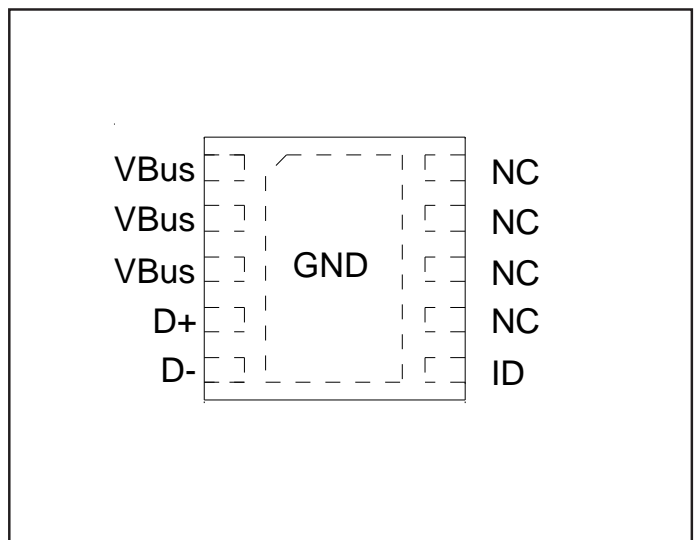

PROTECTION PRODUCTS

Absolute Maximum Rating

Rating	Symbol	Value	Units
DP, DM, USB ID TVS			
Peak Pulse Power (tp = 8/20µs)	P_{pk}	40	Watts
Peak Pulse Current (tp = 8/20µs)	I_{pp}	4	A
ESD per IEC 61000-4-2 (Air) ESD per IEC 61000-4-2 (Contact)	V_{ESD}	±18 ±15	kV
Operating Temperature	T_J	-40 to +85	°C
Storage Temperature	T_{STG}	-55 to +150	°C
VBus TVS			
Peak Pulse Power (tp = 8/20µs)	P_{pk}	4000	Watts
Peak Pulse Current (tp = 8/20µs)	I_{pp}	80	A
ESD per IEC 61000-4-2 (Air) ESD per IEC 61000-4-2 (Contact)	V_{ESD}	±30 ±30	kV
Operating Temperature	T_J	-40 to +85	°C
Storage Temperature	T_{STG}	-55 to +150	°C

Electrical Characteristics (T=25°C Unless Otherwise Specified)

VBus TVS (Pin 1, 2, 3)						
Parameter	Symbol	Conditions	Minimum	Typical	Maximum	Units
Reverse Stand-Off Voltage	V_{RWM}	Pin 1 to GND			26	V
Reverse Breakdown Voltage	V_{BR}	$I_t = 1mA$, Pin 1 to GND	28	29.5	33	V
Reverse Leakage Current	I_R	$V_{RWM} = 26V$ Pin 1 to GND		<0.010	0.100	µA
Forward Voltage	V_F	$I_f = 10mA$ GND to Pin 1	0.6	0.7	1.0	V
Clamping Voltage	V_C	$I_{pp} = 10A$, tp = 8/20µs Pin 1 to Ground			35	V
Clamping Voltage	V_C	$I_{pp} = 58A$, tp = 8/20µs Pin 1 to Ground		39	43	V
Junction Capacitance	C_j	$V_R = 0V$, f = 1MHz Pin 1 to GND		620	750	pF

PROTECTION PRODUCTS

Electrical Characteristics (T=25°C Unless Otherwise Specified)

DM, DP, USB ID (Pins 4, 5, 6)						
Parameter	Symbol	Conditions	Minimum	Typical	Maximum	Units
Reverse Stand-Off Voltage	V_{RWM}	Pin 4, 5, or 6 to GND			4	V
Reverse Breakdown Voltage	V_{BR}	$I_t = 2\mu A$, Pin 4, 5, or 6 to GND	4.2	4.5	5.3	V
Reverse Leakage Current	I_R	$V_{RWM} = 2.0V$, Pin 4, 5, or 6 to GND		<0.005	0.020	μA
Reverse Leakage Current	I_R	$V_{RWM} = 4.0V$, Pin 4, 5, or 6 to GND		<0.010	0.100	μA
Forward Voltage	V_F	$I_f = 15mA$ Pin 4, 5, or 6 to GND	0.6		1.2	V
Clamping Voltage	V_C	$I_{pp} = 1A$, $t_p = 8/20\mu s$ Pin 4, 5, or 6 to GND			8.5	V
Clamping Voltage	V_C	$I_{pp} = 4A$, $t_p = 8/20\mu s$ Pin 4, 5, or 6 to GND			10	V
Dynamic Resistance ¹	R_{dyn}	$I_{pp} = 4A$ to $I_{pp} = 16A$		0.55		Ohms
		$I_{pp} = -4A$ to $I_{pp} = -16A$		0.35		Ohms
Junction Capacitance	C_j	$V_R = 0V$, $f = 1MHz$, Pin 4, 5, or 6 to GND		0.6	0.80	pF
		$V_R = 0V$, $f = 1MHz$, Between I/O pins			0.4	pF

Notes

1) Transmission Line Pulse Test (TLP) Settings: $t_p = 100ns$, $t_r = 0.2ns$, I_{TLP} and V_{TLP} averaging window: $t_1 = 70ns$ to $t_2 = 90ns$

PROTECTION PRODUCTS

Typical Characteristics (T=25°C Unless Otherwise Specified)

**Non-Repetitive Peak Pulse Power vs. Pulse Time
 VBus Pins (Pins 1, 2, 3) Shorted Together**

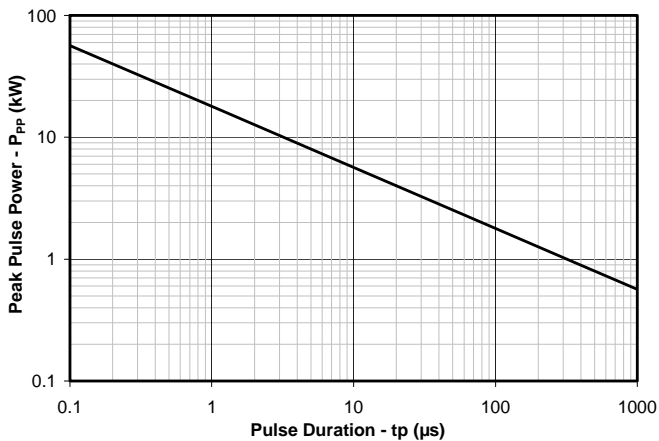

**Non-Repetitive Peak Pulse Power vs. Pulse Time
 D+, D-, ID Pins (Pins 4, 5, 6)**

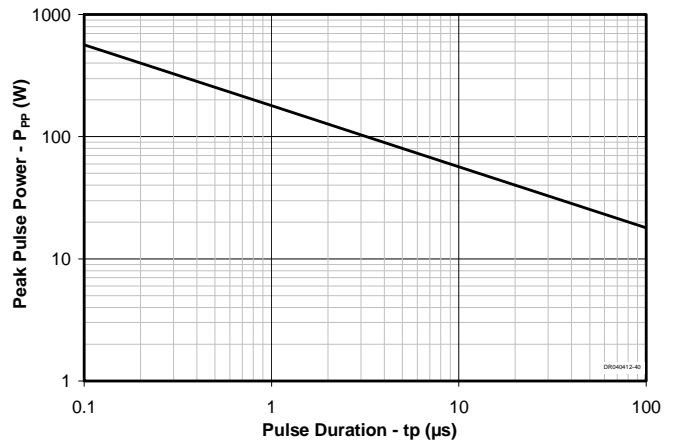

**Clamping Voltage vs. Peak Pulse Current
 VBus Pins (Pins 1, 2, 3) Shorted Together**

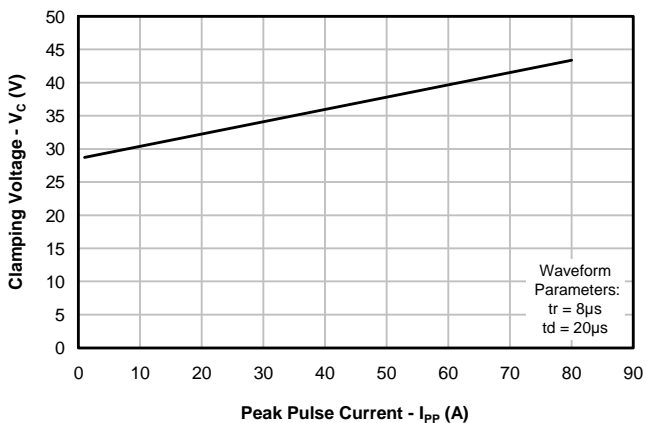

**Forward Voltage vs. Peak Pulse Current
 VBus Pins (Pins 1, 2, 3) Shorted Together**

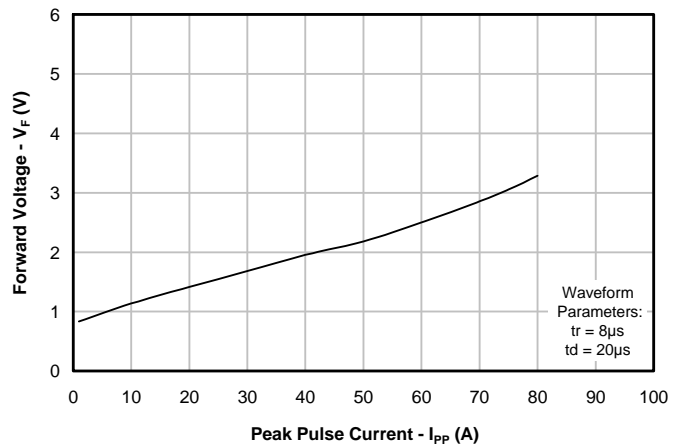

**Clamping Voltage vs. Peak Pulse Current
 D+, D-, ID Pins (Pins 4, 5, 6)**

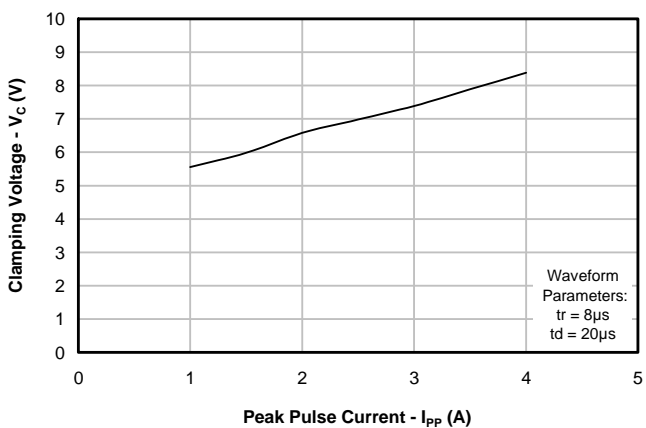

**Forward Voltage vs. Peak Pulse Current
 D+, D-, ID Pins (Pins 4, 5, 6)**

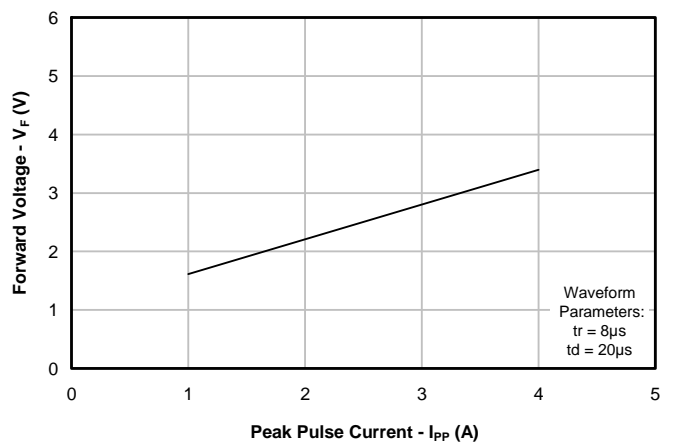

PROTECTION PRODUCTS

Typical Characteristics (T=25°C Unless Otherwise Specified)

**ESD Clamping (+8kV Contact per IEC 61000-4-2)
D+, D-, ID Pins (Pins 4, 5, 6)**

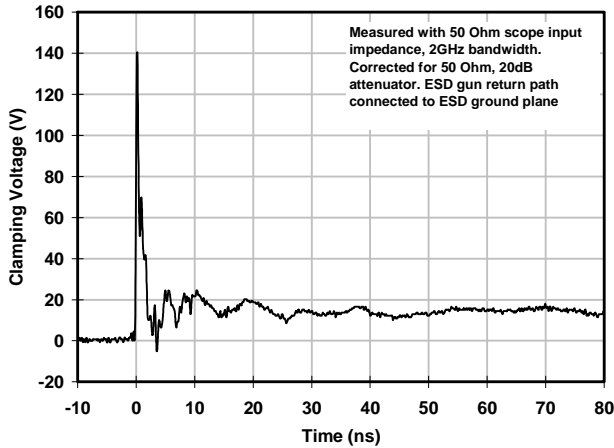

**ESD Clamping (-8kV Contact per IEC 61000-4-2)
D+, D-, ID Pins (Pins 4, 5, 6)**

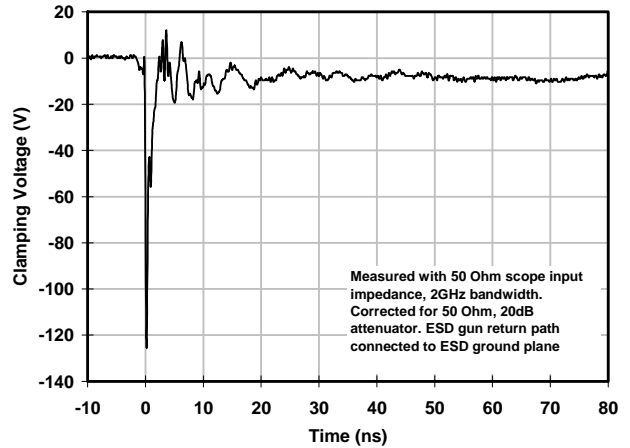

**ESD Clamping (+8kV Contact per IEC 61000-4-2)
VBus Pins (Pins 1, 2, 3)**

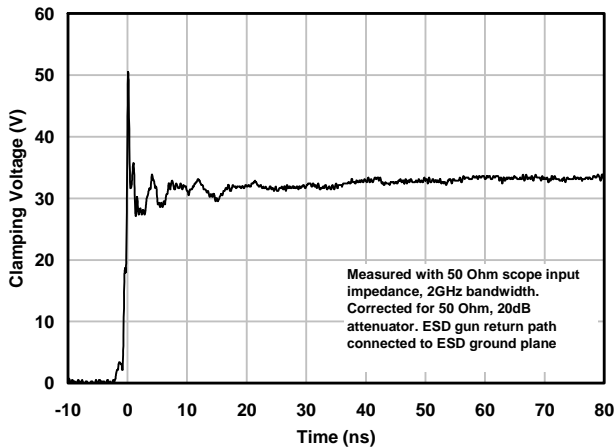

**ESD Clamping (-8kV Contact per IEC 61000-4-2)
VBus Pins (Pins 1, 2, 3)**

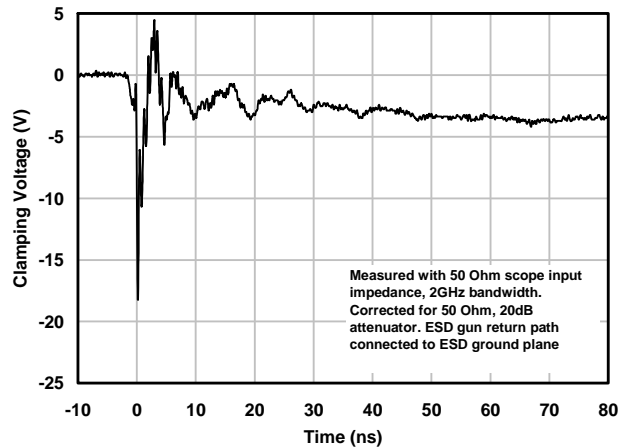

**ESD Clamping +30kV Contact per IEC 61000-4-2)
VBus Pins (Pins 1, 2, 3)**

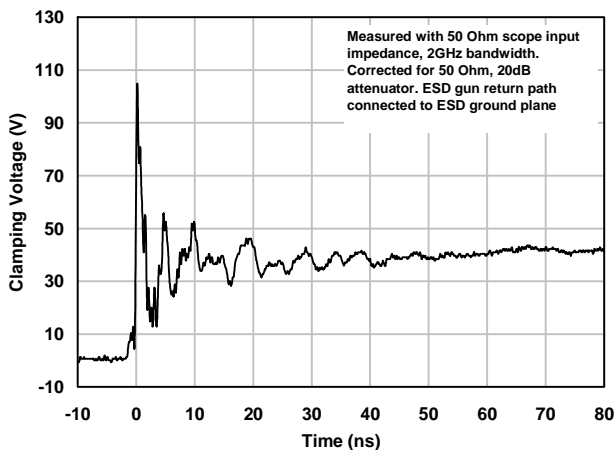

**ESD Clamping -30kV Contact per IEC 61000-4-2)
VBus Pins (Pins 1, 2, 3)**

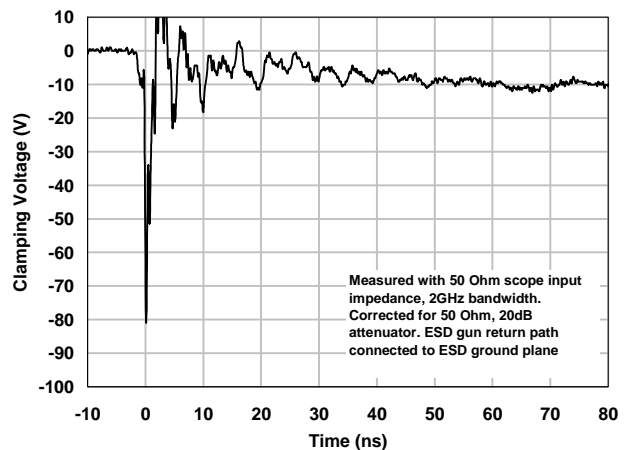

PROTECTION PRODUCTS

Typical Characteristics (T=25°C Unless Otherwise Specified)

TLP Characteristic (Positive Pulse)
D+, D-, ID Pins (Pins 4, 5, 6)

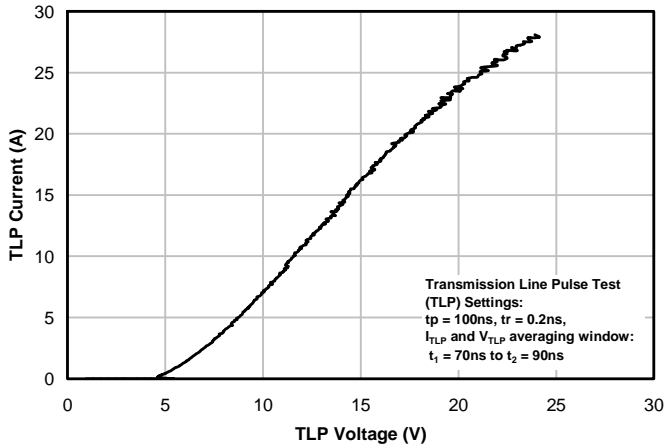

TLP Characteristic (Negative Pulse)
D+, D-, ID Pins (Pins 4, 5, 6)

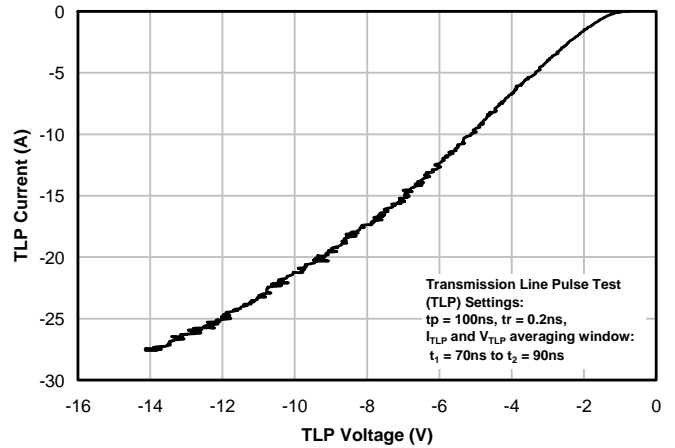

Capacitance vs. Reverse Voltage
D+, D-, ID Pins (Pins 4, 5, 6)

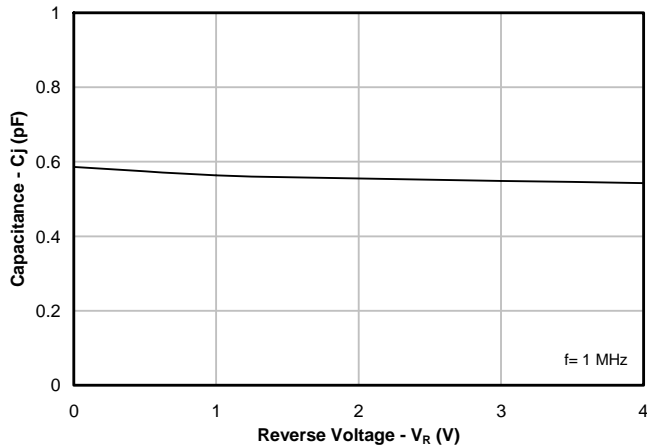

Non-Repetitive Peak Pulse Power Derating Curve

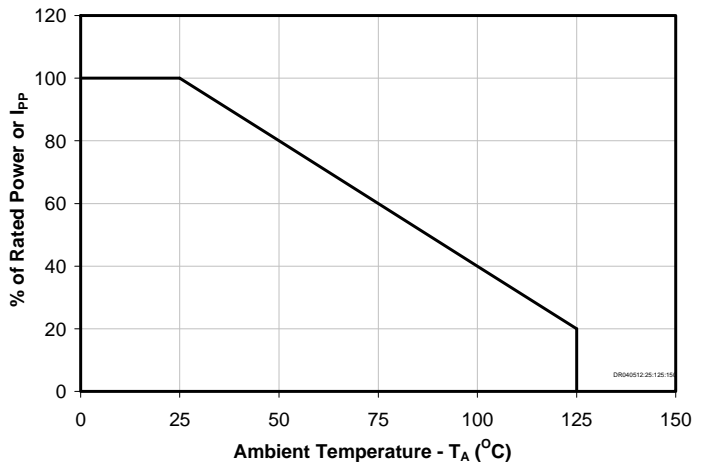

Typical Insertion Loss S21
D+, D-, ID Pins (Pins 4, 5, 6)

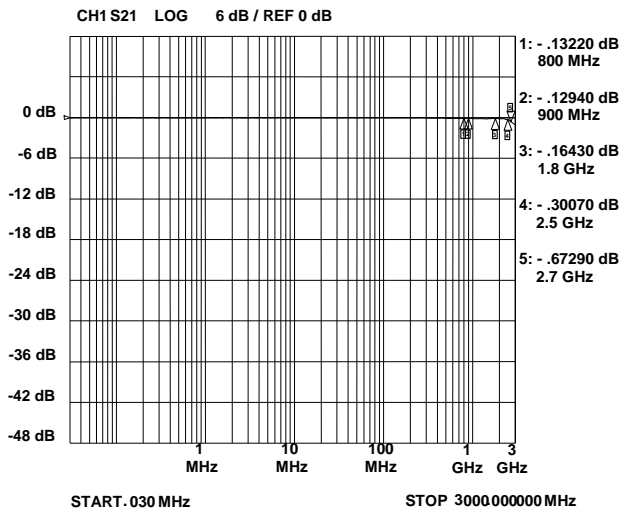

Analog Crosstalk
D+, D-, ID Pins (Pins 4, 5, 6)

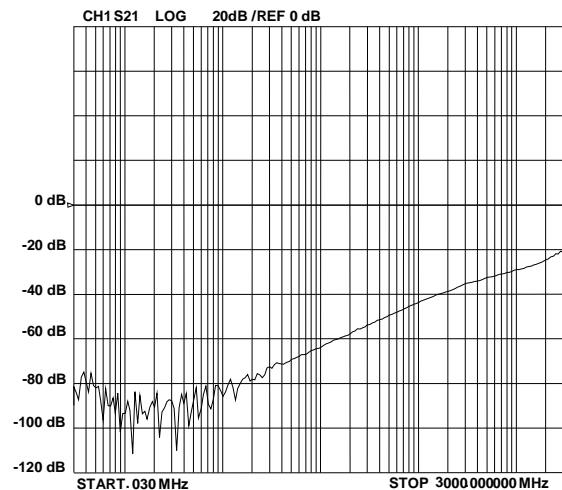

PROTECTION PRODUCTS

Applications Information

Device Connection and Layout Options for Protecting One USB Port

The RClamp2654P is optimized for protection of USB ports. Low capacitance protection is provided for the USB data (DM, DP) and USB ID lines at pins 4, 5, and 6. These inputs are referenced to an internal 4 volt TVS protection device. When the voltage on these lines exceed 4 volts, the TVS will conduct. Pins 1, 2, and 3 are connected to the USB voltage bus (VBus). These three pins must be shorted together on the PCB otherwise the maximum surge capability of the device will be reduced. The VBus TVS has a minimum breakdown voltage of 28V at 1mA. Ground is provided at the center tab. Multiple micro vias connected to ground are recommended for best ESD performance. This will reduce parasitic inductance in the ground path and minimize the clamping voltage seen by the protected device.

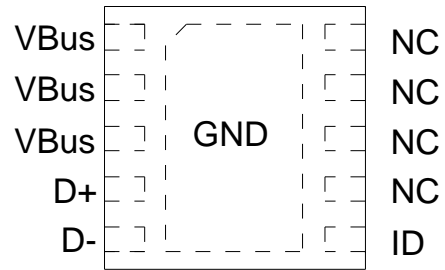

Figure 1 - Pin Configuration (Top View)

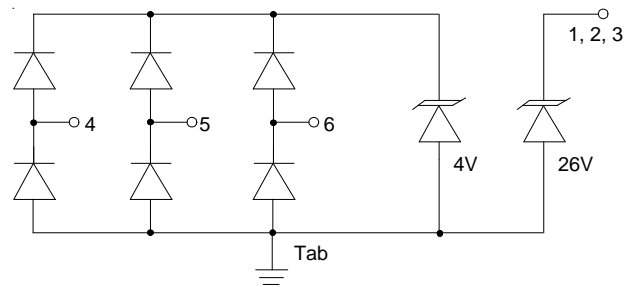
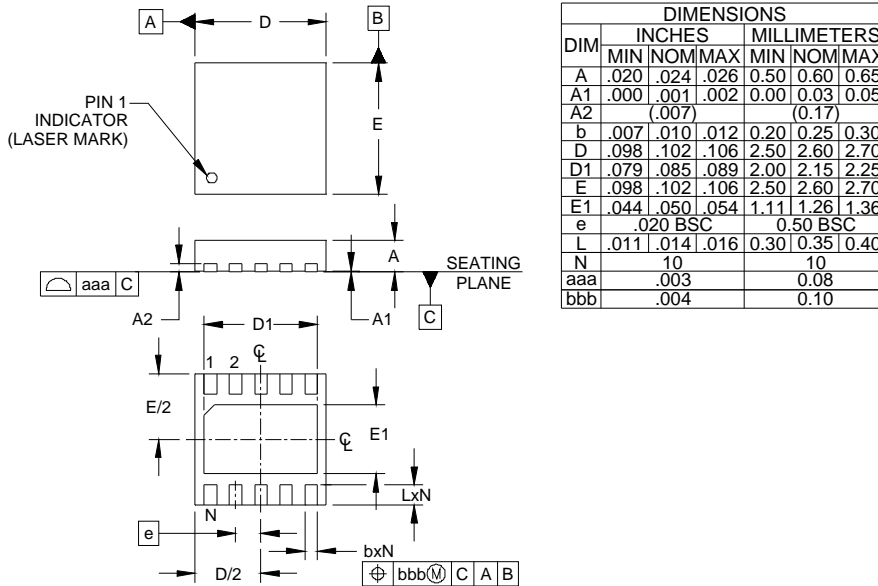

Figure 2 - RClamp2654P Schematic

PROTECTION PRODUCTS

Outline Drawing - SLP2626P10



- NOTES:
1. CONTROLLING DIMENSIONS ARE IN MILLIMETERS (ANGLES IN DEGREES).
 2. COPLANARITY APPLIES TO THE EXPOSED PAD AS WELL AS THE TERMINALS.

Land Pattern - SLP2626P10

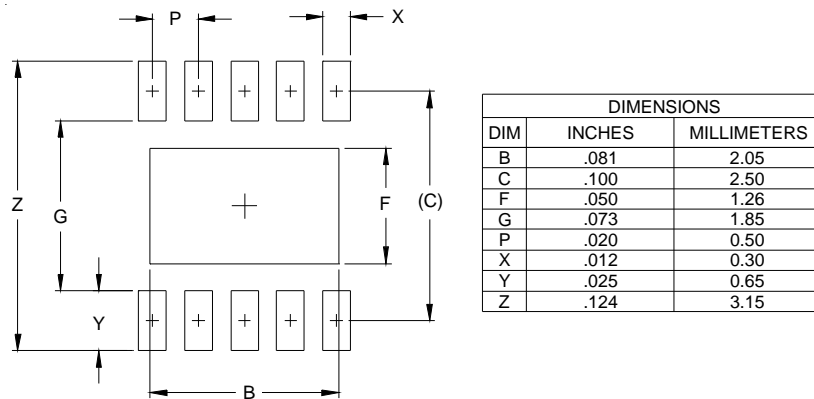

- NOTES:
1. THIS LAND PATTERN IS FOR REFERENCE PURPOSES ONLY. CONSULT YOUR MANUFACTURING GROUP TO ENSURE YOUR COMPANY'S MANUFACTURING GUIDELINES ARE MET.



RClamp2654P

PROTECTION PRODUCTS

Marking Codes

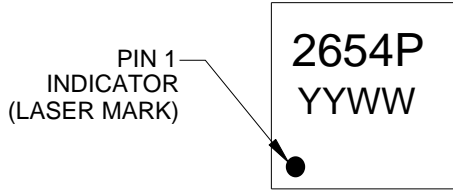

Ordering Information

Part Number	Qty per Reel	Reel Size
RClamp2654P.TCT	3,000	7 Inch

RailClamp and RClamp are trademarks of Semtech Corporation.

YYWW = Date Code

Carrier Tape Specification

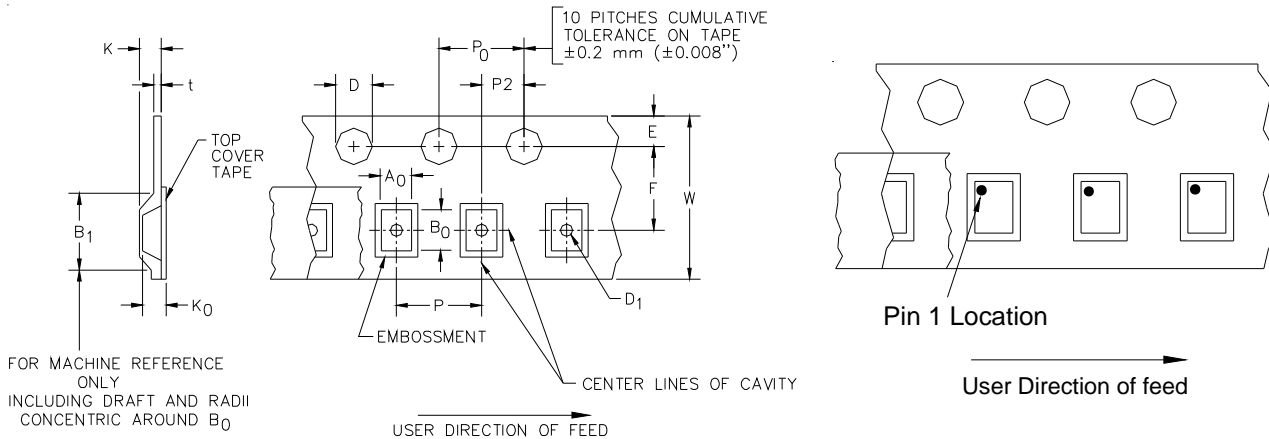

A0	B0	K0
2.77 +/-0.10 mm	2.77 +/-0.10 mm	0.80 +/-0.10 mm

Tape Width	B ₁ (Max)	D	D1	E	F	K (MAX)	P	P0	P2	T(MAX)	W
8 mm	4.2 mm (.165)	1.5 + 0.1 mm - 0.0 mm	1.0 mm ±0.05	1.750±.10 mm	3.5±0.05 mm	2.4 mm	4.0±0.1 mm	4.0±0.1 mm	2.0±0.05 mm	0.4 mm	8.0 mm + 0.3 mm - 0.1 mm

Contact Information

Semtech Corporation
 Protection Products Division
 200 Flynn Road, Camarillo, CA 93012
 Phone: (805)498-2111 FAX (805)498-3804